

Capacitor, aluminum, 22 uF, +/-20% Tol, 25 VDC@85C

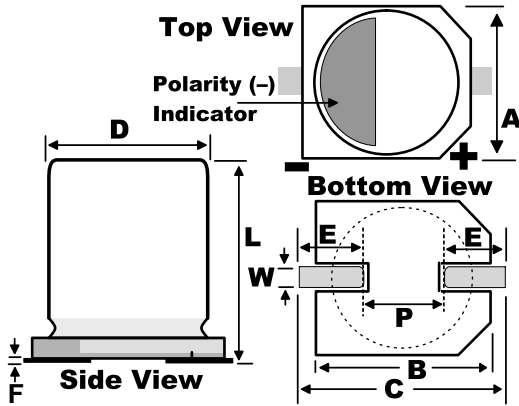

Dimensions (mm)		
Symbol	Dimension	Tolerance
D	5	+/-0.5
L	5.4	+0.25/-0.1
A	5.3	+/-0.2
B	5.3	+/-0.2
C	6.5	MAX
W	0.65	+/-0.1
E	2.2	+/-0.2
P	1.5	+/-0.2
F	0.3	MAX

Packaging Specifications	
Package Kind:	T&R
Package Size:	380mm
Package Quantity:	1000

General Information	
Supplier:	KEMET
Application:	General Purpose
Part Type Description:	Surface Mount Aluminum Electrolytic
Lead Type:	V-Chip
RoHS:	Yes

Specifications	
Capacitance:	22 uF
Voltage:	25 VDC
Tolerance:	+/-20%
Voltage:	32 VDC (Surge)
Rated Temperature:	85C
Temperature Range:	-40/+85C
Life:	2000 Hrs
Leakage Current:	5.5 uA
Leakage Condition:	uAmps (2min 20C)
Dissipation Factor:	20%
Impedance Ratio -25C:	2.0
Impedance Ratio -40C:	4.0
Current/Ripple Current:	35 mAmps (120Hz)
Current/Ripple Current:	47.6 mAmps (120Hz 50C)