

Capacitor, aluminum, 2200 uF, +/-20% Tol, -40/+85C, 63 VDC@85C

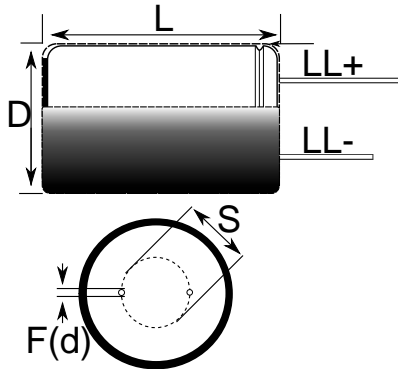

Note: '()' correspond to the letters used in the product bulletin

Dimensions (mm)		
Symbol	Dimension	Tolerance
D	18	+/-0.5
L	40	+2
S	7.5	+/-0.5
LLPos	20	MIN
LLNeg	15	MIN
F	0.8	NOM

Packaging Specifications	
Package Kind:	Bulk
Package Type:	Bag
Package Quantity:	500

General Information	
Supplier:	KEMET
Application:	General Purpose
Part Type Description:	Single Ended, Aluminum Electrolytic
Lead Type:	Wire Leads
RoHS:	Yes

Specifications	
Capacitance:	2200 uF
Voltage:	63 VDC
Tolerance:	+/-20%
Voltage:	79 VDC (Surge)
Life:	2000 Hrs
Rated Temperature:	85C
Temperature Range:	-40/+85C
Leakage Current:	1.386 mA
Leakage Condition:	uAmps (2min 20C)
Dissipation Factor:	9%
Impedance Ratio -25C:	3.0
Impedance Ratio -40C:	3.0
Current/Ripple Current:	2200 mAmps (120Hz 85C)