

Capacitor, ceramic, 1000 pF, +/-20% Tol, 440 V, Y5V, Lead Spacing=7.5 mm

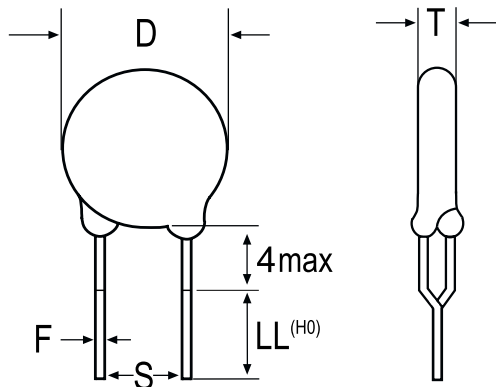

General Information	
Supplier:	KEMET
Application:	Safety:X1/Y2
Temperature Coefficient:	Y5V
Body Type:	Radial Disc
Lead Form:	vcrimp
Termination Type:	Tin (Sn)
RoHS:	Yes
Halogen Free:	Yes

Dimensions (mm)		
Symbol	Dimension	Tolerance
D	7	MAX
T	5	MAX
S	7.5	+/-1
LL	18	+2/-0
F	0.5	+/-0.1

Specifications	
Capacitance:	1000 pF
Voltage:	440 VAC (X)
Voltage:	300 VAC (Y)
Tolerance:	+/-20%
Temperature Range:	-40/+125C
Failure Rate:	N/A
Dissipation Factor:	5%
Insulation Resistance:	10 GOhm
Dielectric Strength:	2600 V

Packaging Specifications	
Package Kind:	Ammo
Package Quantity:	1000

Statements of suitability for certain applications are based on our knowledge of typical operating conditions for such applications, but are not intended to constitute - and we specifically disclaim - any warranty concerning suitability for a specific customer application or use. This Information is intended for use only by customers who have the requisite experience and capability to determine the correct products for their application. Any technical advice inferred from this Information or otherwise provided by us with reference to the use of our products is given gratis, and we assume no obligation or liability for the advice given or results obtained.