

KEMET Part Number: C340C475M5U5TA
(C340C475M5U5TABULK)

Capacitor, ceramic, 4.7 uF, +/-20% Tol, 50 V, Z5U, Lead Spacing=0.2"

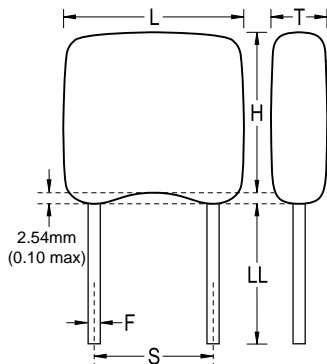

Dimensions (mm)		
Symbol	Dimension	Tolerance
L	7.36	MAX
H	8.13	MAX
T	4.07	MAX
S	5.08	NOM
LL	7	MIN
F	0.51	NOM

Packaging Specifications	
Package Kind:	Bulk
Package Type:	Bag
Package Quantity:	100

General Information	
Supplier:	KEMET
Application:	General Purpose
Temperature Coefficient:	Z5U
Body Type:	Radial Conformal
Lead Type:	Wire Leads
Termination Type:	Tin (Sn)
RoHS:	Yes

Specifications	
Capacitance:	4.7 uF
Voltage:	50 V
Tolerance:	+/-20%
Temperature Range:	+10/+85C
Failure Rate:	N/A
Dissipation Factor:	10%
Insulation Resistance:	20 MOhm
Dielectric Strength:	125 V