

Capacitor, aluminum, 220 uF, +/-20% Tol, 35 VDC@85C

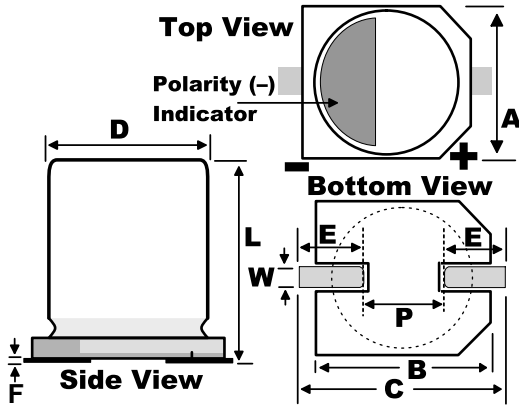

Dimensions (mm)		
Symbol	Dimension	Tolerance
D	8	+/-0.5
L	10.2	+/-0.3
A	8.3	+/-0.2
B	8.3	+/-0.2
C	10	MAX
W	0.9	+/-0.2
E	3.4	+/-0.2
P	3.1	+/-0.2
F	0.3	MAX

Packaging Specifications	
Package Kind:	T&R
Package Size:	380mm
Package Quantity:	500

General Information	
Supplier:	KEMET
Application:	General Purpose
Part Type Description:	Surface Mount Aluminum Electrolytic
Lead Type:	V-Chip
RoHS:	Yes

Specifications	
Capacitance:	220 uF
Voltage:	35 VDC
Tolerance:	+/-20%
Voltage:	44 VDC (Surge)
Rated Temperature:	85C
Temperature Range:	-40/+85C
Life:	2000 Hrs
Leakage Current:	77 uA
Leakage Condition:	uAmps (2min 20C)
Dissipation Factor:	14%
Impedance Ratio -25C:	2.0
Impedance Ratio -40C:	3.0
Current/Ripple Current:	200 mAmps (120Hz)
Current/Ripple Current:	272 mAmps (120Hz 50C)