

Capacitor, aluminum, 3300 uF, +/-20% Tol, -40/+105C, 10 VDC@105C

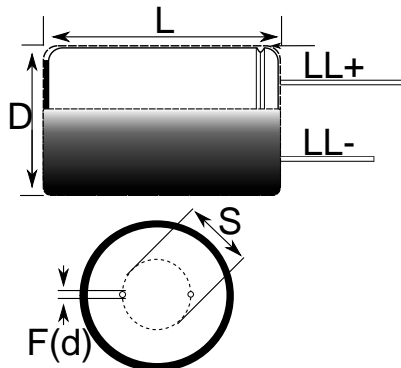

Note: '()' correspond to the letters used in the product bulletin

Dimensions (mm)		
Symbol	Dimension	Tolerance
D	13	+/-0.5
L	25	+2
S	5	+/-0.5
LLPos	20	MIN
LLNeg	15	MIN
F	0.6	NOM

Packaging Specifications	
Package Kind:	Bulk
Package Type:	Bag
Package Quantity:	1600

General Information	
Supplier:	KEMET
Application:	105C
Part Type Description:	High CV Single Ended Aluminum Electrolytic
Lead Type:	Wire Leads
RoHS:	Yes

Specifications	
Capacitance:	3300 uF
Voltage:	10 VDC
Tolerance:	+/-20%
Voltage:	13 VDC (Surge)
Life:	2000 Hrs
Rated Temperature:	105C
Temperature Range:	-40/+105C
Leakage Current:	330 uA
Leakage Condition:	uAmps (2min 20C)
Dissipation Factor:	22%
Impedance Ratio -25C:	3.0
Impedance Ratio -40C:	6.0
Current/Ripple Current:	1220 mAmps (120Hz 105C)