

Capacitor, aluminum, 10 uF, +/-20% Tol, -40/+105C, 63 VDC@105C

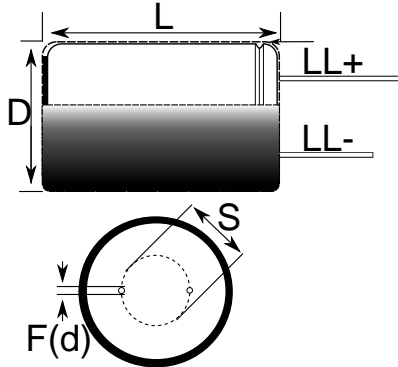

Note: '()' correspond to the letters used in the product bulletin

Dimensions (mm)		
Symbol	Dimension	Tolerance
D	5	+/-0.5
L	11	+1.5
S	2	+/-0.5
LLPos	20	MIN
LLNeg	15	MIN
F	0.5	NOM

Packaging Specifications	
Package Kind:	Bulk
Package Type:	Bag
Package Quantity:	10000

General Information	
Supplier:	KEMET
Application:	105C
Part Type Description:	High CV Single Ended Aluminum Electrolytic
Lead Type:	Wire Leads
RoHS:	Yes

Specifications	
Capacitance:	10 uF
Voltage:	63 VDC
Tolerance:	+/-20%
Voltage:	79 VDC (Surge)
Life:	2000 Hrs
Rated Temperature:	105C
Temperature Range:	-40/+105C
Leakage Current:	6.3 uA
Leakage Condition:	uAmps (2min 20C)
Dissipation Factor:	10%
Impedance Ratio -25C:	2.0
Impedance Ratio -40C:	3.0
Current/Ripple Current:	55 mAmps (120Hz 105C)