

Type 4 Mild Steel Junction Box *Eclipse Junior Series*

Continuous Hinge Door with Quarter Turn



Application

- Designed to enclose electrical and/or electronic equipment and protect against harsh, industrial environments.
- For use as instrument enclosures, electric, hydraulic or pneumatic control housings, electrical junction boxes or terminal wiring enclosures.
- Impressive styling features make the Eclipse Junior a suitable addition to any high-tech equipment installation.

Standards

- UL 508 Type 3R, 4, 12 and 13
- CSA Type 3R, 4, 12 and 13
- Complies with
 - NEMA Type 3R, 4, 12 and 13
 - IEC 60529, IP66

Construction

- Body and cover are formed from 16 gauge steel.
- Smooth, continuously welded seams without knockouts, cutouts, or holes.
- Formed lip on enclosure to exclude flowing liquids and contaminants.
- 14 gauge welded brackets provide for enclosure mounting.
- Continuously hinged cover has 304 stainless steel hinges and provides 180° opening.
- Door latches feature the added safety of quarter turn slot requiring use of tool for opening.
- Quarter turn latches formed from black zinc diecast.
- Seamless poured-in place gasket.
- Models larger than 4"x4" include a removable 14 gauge galvanized inner panel.
- Internal threaded weld studs are provided for mounting inner panels.
- A bonding stud is provided on the door and a grounding stud is provided on the enclosure.
- Grounding and panel mounting hardware provided.

Finish

- Cover and enclosure are finished with a recoatable powder inside and out with choice of ANSI 61 smooth Gray (GY) or RAL7035 textured light gray (LG).
- Inner panels are unpainted galvanized steel.

Accessories

- Inner Panels
- Ventilation
- Filtered Fans
- Type 1 Louvered Ventilating Plates

- Padlock Adaptor
- Temperature Controls
- Swing Panel Kit
- Terminal Kit Assemblies
- Wing Knob Lock

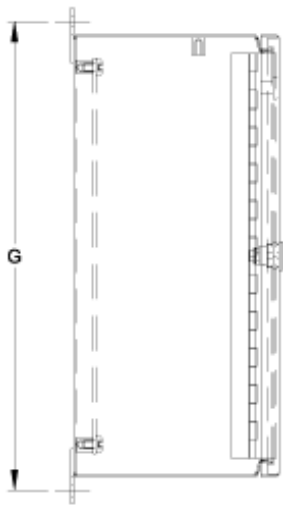

Hinge Side View

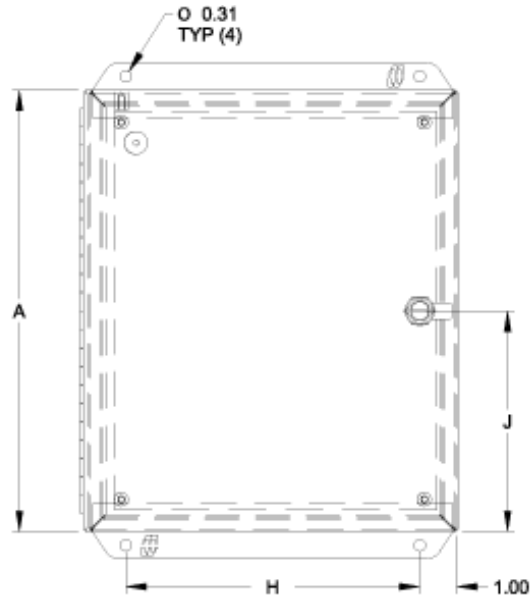

Front View

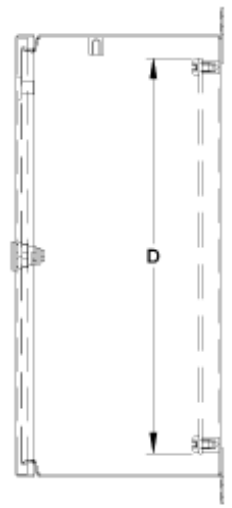

Latch Side View

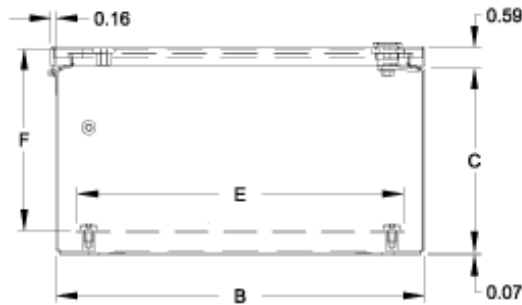

End View

Part No. (ANSI 61 Gray)	Part No. (RAL 7035 Light Gray)	Overall Dimensions					Panel Size				Ship Wt. (lbs)
		A	B	C	H	G	D	E	J	F	
EJ443	EJ443LG	4.00	4.00	3.00	2.00	4.75	-	-	2.00	-	2
EJ643	EJ643LG	6.00	4.00	3.00	2.00	6.75	4.88	2.88	3.00	2.92	2
EJ683	EJ683LG	6.00	8.00	3.50	6.00	6.75	4.88	6.75	3.00	3.42	5
EJ863	EJ863LG	8.00	6.00	3.50	4.00	8.75	6.75	4.88	4.00	3.42	5
EJ444	EJ444LG	4.00	4.00	4.00	2.00	4.75	-	-	2.00	-	3
EJ644	EJ644LG	6.00	4.00	4.00	2.00	6.75	4.88	2.88	3.00	3.92	3
EJ664	EJ664LG	6.00	6.00	4.00	4.00	6.75	4.88	4.88	3.00	3.92	4
EJ884	EJ884LG	8.00	8.00	4.00	6.00	8.75	6.75	6.88	4.00	3.92	7
EJ8104	EJ8104LG	8.00	10.00	4.00	8.00	8.75	6.88	8.75	4.00	3.92	8
EJ1084	EJ1084LG	10.00	8.00	4.00	6.00	10.75	8.75	6.88	5.00	3.92	8
EJ1264	EJ1264LG	12.00	6.00	4.00	4.00	12.75	10.75	4.88	6.00	3.92	8
EJ12124	EJ12124LG	12.00	12.00	4.00	10.00	12.75	10.75	10.88	6.00	5.92	15
EJ10125	EJ10125LG	10.00	12.00	5.00	10.00	10.75	8.88	10.75	5.00	4.92	10
EJ12105	EJ12105LG	12.00	10.00	5.00	8.00	12.75	10.75	8.88	6.00	4.92	12
EJ866	EJ866LG	8.00	6.00	6.00	4.00	8.75	6.75	4.88	4.00	5.92	7
EJ1086	EJ1086LG	10.00	8.00	6.00	6.00	10.75	8.75	6.88	5.00	5.92	10
EJ10106	EJ10106LG	10.00	10.00	6.00	8.00	10.75	8.75	8.88	5.00	5.92	12
EJ12126	EJ12126LG	12.00	12.00	6.00	10.00	12.75	10.75	10.88	6.00	5.92	15

Part No. (ANSI 61 Gray)	Part No. (RAL 7035 Light Gray)	Overall Dimensions					Panel Size				Ship Wt. (lbs)
		A	B	C	H	G	D	E	J	F	
EJ12146	EJ12146LG	12.00	14.00	6.00	12.00	12.75	10.88	12.75	6.00	5.92	17
EJ1486	EJ1486LG	14.00	8.00	6.00	6.00	14.75	12.75	6.88	7.00	5.92	10
EJ14126	EJ14126LG	14.00	12.00	6.00	10.00	14.75	12.75	10.88	7.00	5.92	17
EJ14166	EJ14166LG	14.00	16.00	6.00	14.00	14.75	12.88	14.75	7.00	5.92	21
EJ16106	EJ16106LG	16.00	10.00	6.00	8.00	16.75	14.75	8.88	8.00	5.92	15
EJ16146	EJ16146LG	16.00	14.00	6.00	12.00	16.75	14.75	12.88	8.00	5.92	21
EJ12108	EJ12108LG	12.00	10.00	8.00	8.00	12.75	10.75	8.88	6.00	7.92	15
EJ14128	EJ14128LG	14.00	12.00	8.00	10.00	14.75	12.75	10.88	7.00	7.92	18
EJ16148	EJ16148LG	16.00	14.00	8.00	12.00	16.75	14.75	12.88	8.00	7.92	22
EJ161410	EJ161410LG	16.00	14.00	10.00	12.00	16.75	14.75	12.88	8.00	9.92	23

Data subject to change without notice

© 2016. Hammond Manufacturing Ltd. All rights reserved.