

PLEASE CHECK WWW.MOLEX.COM FOR LATEST PART INFORMATION

Part Number: [0522070633](#)
Status: **Active**
Overview: FFC-FPC (SMT)
Description: Easy-On™ Type FFC/FPC Connector, Right-Angle, Surface Mount, ZIF, Top Contact Style Receptacle, 6 Circuits, High Barrier Packaging

Documents:

[3D Model](#) [Packaging Specification SPK-52207-002 \(PDF\)](#)
[Drawing \(PDF\)](#) [RoHS Certificate of Compliance \(PDF\)](#)
[Product Specification PS-52207-009 \(PDF\)](#)

Agency Certification

CSA LR19980
 UL E29179

General

Product Family FFC/FPC Connectors
 Series [52207](#)
 Overview [FFC-FPC \(SMT\)](#)
 Product Name Easy-On™
 UPC 887191276373

Physical

Circuits (Loaded) 6
 Color - Resin Natural
 Contact Position Top
 Durability (mating cycles max) 30
 Entry Angle 90° Angle
 Flammability 94V-0
 Mated Height 2.70mm
 Material - Metal Phosphor Bronze
 Material - Plating Mating Silver, Tin-Bismuth
 Material - Plating Termination Silver, Tin-Bismuth
 Material - Resin Nylon
 Net Weight 311.500/mg
 Number of Rows 1
 Orientation Right Angle
 PC Tail Length 2.00mm
 PCB Locator No
 PCB Retention Yes
 Packaging Type Embossed Tape on Reel
 Pitch - Mating Interface 1.00mm
 Pitch - Termination Interface 1.00mm
 Polarized to PCB Yes
 Stackable No
 Temperature Range - Operating -40°C to +85°C
 Termination Interface: Style Surface Mount
 Wire/Cable Type FFC/FPC

Electrical

Current - Maximum per Contact 1.0A
 Voltage - Maximum 125V

Material Info

Reference - Drawing Numbers

Packaging Specification SPK-52207-002

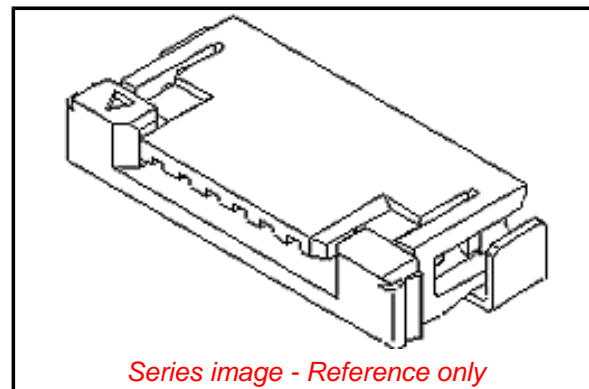

Series image - Reference only

EU ELV

Not Relevant

EU RoHS

Compliant

REACH SVHC

Not Contained Per
 -ED/79/2015 (17
 December 2015)

Halogen-Free

Status

Not Low-Halogen

**Need more information on product
 environmental compliance?**

Email productcompliance@molex.com
 Please visit the [Contact Us](#) section for any
 non-product compliance questions.

China ROHS

ELV

Green Image

Not Relevant

Search Parts in this Series

[52207 Series](#)

Mates With

Molex Premo-Flex FFC. Be sure to match like plating

Product Specification

Sales Drawing

PS-52207-009, RPS-52207-115, RPS-52207-120,
RPS-52207-123
SD-52207-069, SD-52207-070

This document was generated on 03/11/2016

PLEASE CHECK WWW.MOLEX.COM FOR LATEST PART INFORMATION