

PLEASE CHECK WWW.MOLEX.COM FOR LATEST PART INFORMATION

Part Number: [0855025009](#)
Status: **Active**
Overview: Modular Jacks and Plugs
Description: Modular Jack, Right Angle, Surface Mount, 4/4, Low Profile, Pin-in-Hole-Reflow, Tape & Reel

Documents:

3D Model	Test Summary STR-1413 (PDF)
Drawing (PDF)	RoHS Certificate of Compliance (PDF)
Product Specification PS-95501 (PDF)	Product Literature (PDF)
Application Specification AS-85513-001 (PDF)	

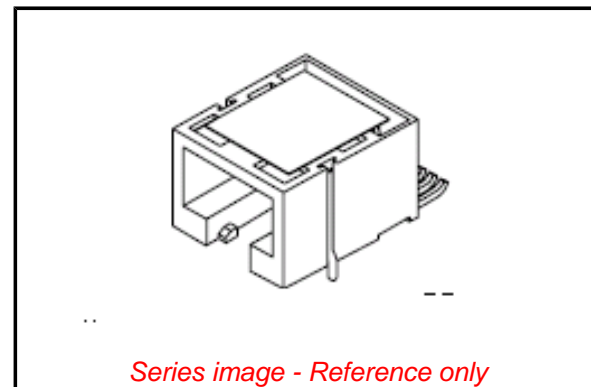

Agency Certification

UL E107635

General

Product Family	Modular Jacks/Plugs
Series	85502
Comments	Reflow capable
Component Type	PCB Jack
Magnetic	No
Overview	Modular Jacks and Plugs
Performance Category	3
Power over Ethernet (PoE)	N/A
Product Literature Order No	987650-8441
Product Name	RJ11
UPC	822350870511

Physical

Boot Color	N/A
Color - Resin	Black
Durability (mating cycles max)	2500
Flammability	94V-0
Inverted / Top Latch	No
Jack Height	11.50mm
Lightpipes/LEDs	None
Material - Metal	Copper Alloy
Material - Plating Mating	Gold over Palladium Nickel
Material - Plating Termination	Tin
Material - Resin	High Temperature Thermoplastic
Net Weight	1.853/g
Orientation	Right Angle (Side Entry)
PCB Locator	Yes
PCB Retention	Yes
PCB Thickness - Recommended	1.57mm
Packaging Type	Embossed Tape on Reel
Pitch - Mating Interface	1.02mm
Pitch - Termination Interface	1.27mm
Plating min - Mating	0.051µm, 0.600µm
Plating min - Termination	1.905µm
Ports	1
Positions / Loaded Contacts	4/4
Surface Mount Compatible (SMC)	Yes
Temperature Range - Operating	-40°C to +85°C
Termination Interface: Style	Surface Mount
Waterproof / Dustproof	No
Wire/Cable Type	N/A

EU ELV

Not Relevant

EU RoHS

Compliant

REACH SVHC

Not Contained Per
-ED/79/2015 (17
December 2015)

Halogen-Free

Status

Low-Halogen

Need more information on product environmental compliance?

Email productcompliance@molex.com
Please visit the [Contact Us](#) section for any non-product compliance questions.

China ROHS
ELV

Green Image
Not Relevant

Search Parts in this Series

[85502 Series](#)

Mates With

[90075 Modular Plug](#)

Electrical

Current - Maximum per Contact	1.5A
Shielded	No
Voltage - Maximum	125V DC

Solder Process Data

Duration at Max. Process Temperature (seconds)	045
Lead-free Process Capability	REFLOW
Max. Cycles at Max. Process Temperature	003
Process Temperature max. C	260

Material Info**Reference - Drawing Numbers**

Application Specification	AS-85513-001
Product Specification	PS-95501
Sales Drawing	SD-85502-103
Test Summary	STR-1413

This document was generated on 03/02/2016

PLEASE CHECK WWW.MOLEX.COM FOR LATEST PART INFORMATION