

**PLEASE CHECK WWW.MOLEX.COM FOR LATEST PART INFORMATION**

**Part Number:** [0950097661](#)  
**Status:** **Active**  
**Overview:** [Modular Jacks and Plugs](#)  
**Description:** Modular Jack, Right Angle, Through Hole, 6/6, Panel Stops

**Documents:**

<a href="#">3D Model</a>	<a href="#">Test Summary STR-1422 (PDF)</a>
<a href="#">Drawing (PDF)</a>	<a href="#">RoHS Certificate of Compliance (PDF)</a>
<a href="#">Product Specification PS-95009-001 (PDF)</a>	<a href="#">Product Literature (PDF)</a>

**Agency Certification**

UL E107635

**General**

Product Family	Modular Jacks/Plugs
Series	<a href="#">95009</a>
Comments	Flush Mount
Component Type	PCB Jack
Magnetic	No
Overview	<a href="#">Modular Jacks and Plugs</a>
Performance Category	3
Power over Ethernet (PoE)	N/A
Product Literature Order No	987650-8441
Product Name	RJ11
UPC	884982793804

**Physical**

Color - Resin	Black
Durability (mating cycles max)	2500
Flammability	94V-0
Inverted / Top Latch	No
Jack Height	16.00mm
Lightpipes/LEDs	None
Material - Metal	Copper Alloy
Material - Plating Mating	Gold over Palladium Nickel
Material - Plating Termination	Tin
Material - Resin	High Temperature Thermoplastic
Net Weight	2.720/g
Orientation	Right Angle (Side Entry)
PCB Locator	Yes
PCB Retention	Yes
PCB Thickness - Recommended	1.57mm
Packaging Type	Tray
Panel Mount	With Flange
Pitch - Mating Interface	1.02mm
Pitch - Termination Interface	1.27mm
Plating min - Mating	1.270µm
Plating min - Termination	1.905µm
Ports	1
Positions / Loaded Contacts	6/6
Surface Mount Compatible (SMC)	No
Temperature Range - Operating	-40°C to +80°C
Termination Interface: Style	Through Hole
Waterproof / Dustproof	No
Wire/Cable Type	N/A

**Electrical**

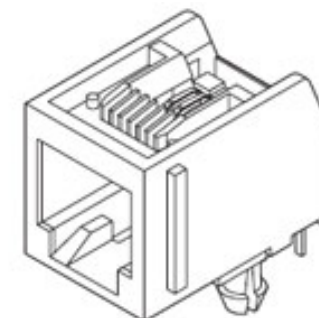

*Series image - Reference only*

**EU ELV**

**Not Relevant**

**EU RoHS**

**Compliant**

**REACH SVHC**

Not Contained Per  
-ED/79/2015 (17  
December 2015)

**Halogen-Free**

**Status**

**Not Low-Halogen**

**Need more information on product environmental compliance?**

Email [productcompliance@molex.com](mailto:productcompliance@molex.com)  
Please visit the [Contact Us](#) section for any non-product compliance questions.

China ROHS

ELV

Green Image

Not Relevant

**Search Parts in this Series**

[95009 Series](#)

**Mates With**

FCC 68 Plugs

Current - Maximum per Contact	1.5A
Shielded	No
Voltage - Maximum	125V DC

**Material Info**

**Reference - Drawing Numbers**

Product Specification	PS-95009-001
Sales Drawing	SDA-95009-F
Test Summary	STR-1422

This document was generated on 03/07/2016

**PLEASE CHECK [WWW.MOLEX.COM](http://WWW.MOLEX.COM) FOR LATEST PART INFORMATION**