



Features

- 72 V rated
- Radial leaded devices
- Cured, flame retardant epoxy polymer insulating material meets UL 94 V-0 requirements
- RoHS compliant* and halogen free**
- Agency recognition:  

Applications

Almost anywhere there is a low voltage power supply, up to 72 V and a load to be protected, including:

- Security and fire alarm systems
- Loudspeakers
- Power transformers

MF-RX/72 Series - PTC Resettable Fuses

Electrical Characteristics

| Model | V max. Volts | I max. Amps | I _{hold} | | I _{trip} | | Initial Resistance | | 1 Hour (R ₁) Post-Trip Resistance | Max. Time To Trip | | Tripped Power Dissipation |
|-------------|--------------|-------------|-------------------|------|-------------------|------|--------------------|-------|---|-------------------|------------------|---------------------------|
| | | | Amperes at 23 °C | | Ohms at 23 °C | | Ohms at 23 °C | | Ohms at 23 °C | Amperes at 23 °C | Seconds at 23 °C | Watts at 23 °C |
| | | | Hold | Trip | Min. | Max. | Max. | | | Typ. | | |
| MF-RX020/72 | 72 | 40 | 0.20 | 0.40 | 1.50 | 2.84 | 4.40 | 1.0 | 2.2 | 0.40 | | |
| MF-RX025/72 | 72 | 40 | 0.25 | 0.50 | 1.00 | 1.95 | 3.00 | 1.25 | 2.5 | 0.45 | | |
| MF-RX030/72 | 72 | 40 | 0.30 | 0.60 | 0.76 | 1.36 | 2.10 | 1.5 | 3.0 | 0.50 | | |
| MF-RX040/72 | 72 | 40 | 0.40 | 0.80 | 0.52 | 0.86 | 1.29 | 2.0 | 3.9 | 0.55 | | |
| MF-RX050/72 | 72 | 40 | 0.50 | 1.00 | 0.41 | 0.77 | 1.17 | 2.5 | 4.0 | 0.75 | | |
| MF-RX065/72 | 72 | 40 | 0.65 | 1.30 | 0.27 | 0.48 | 0.72 | 3.25 | 5.3 | 0.90 | | |
| MF-RX075/72 | 72 | 40 | 0.75 | 1.50 | 0.18 | 0.40 | 0.60 | 3.75 | 6.3 | 0.90 | | |
| MF-RX090/72 | 72 | 40 | 0.90 | 1.80 | 0.14 | 0.31 | 0.47 | 4.5 | 7.2 | 1.00 | | |
| MF-RX110/72 | 72 | 40 | 1.10 | 2.20 | 0.15 | 0.25 | 0.38 | 5.5 | 8.2 | 1.50 | | |
| MF-RX135/72 | 72 | 40 | 1.35 | 2.70 | 0.12 | 0.19 | 0.30 | 6.75 | 9.6 | 1.70 | | |
| MF-RX160/72 | 72 | 40 | 1.60 | 3.20 | 0.09 | 0.14 | 0.22 | 8.0 | 11.4 | 1.90 | | |
| MF-RX185/72 | 72 | 40 | 1.85 | 3.70 | 0.08 | 0.12 | 0.19 | 9.25 | 12.6 | 2.10 | | |
| MF-RX250/72 | 72 | 40 | 2.50 | 5.00 | 0.05 | 0.08 | 0.13 | 12.5 | 15.6 | 2.50 | | |
| MF-RX300/72 | 72 | 40 | 3.00 | 6.00 | 0.04 | 0.06 | 0.10 | 15.0 | 19.8 | 2.80 | | |
| MF-RX375/72 | 72 | 40 | 3.75 | 7.50 | 0.03 | 0.05 | 0.08 | 18.75 | 24.0 | 3.20 | | |

Environmental Characteristics

| | |
|---|---|
| Operating/Storage Temperature | -40 °C to +85 °C |
| Maximum Device Surface Temperature in Tripped State | 125 °C |
| Passive Aging | +85 °C, 1000 hours..... ±5 % typical resistance change |
| Humidity Aging..... | +85 °C, 85 % R.H. 1000 hours ±5 % typical resistance change |
| Thermal Shock | +85 °C to -55 °C, 10 times..... ±10 % typical resistance change |
| Solvent Resistance..... | MIL-STD-202, Method 215 No change |
| Vibration | MIL-STD-883C, Method 2007.1,..... No change Condition A |

Test Procedures And Requirements For Model MF-RX/72 Series

| Test | Test Conditions | Accept/Reject Criteria |
|------------------------------|---|---|
| Visual/Mech. | Verify dimensions and materials | Per MF physical description |
| Resistance..... | In still air @ 23 °C | R _{min} ≤ R ≤ R _{max} |
| Time to Trip..... | 5 times I _{hold} , V _{max} , 23 °C | T ≤ max. time to trip (seconds) |
| Hold Current | 30 min. at I _{hold} | No trip |
| Trip Cycle Life..... | V _{max} , I _{max} , 100 cycles..... | No arcing or burning |
| Trip Endurance | V _{max} , 48 hours..... | No arcing or burning |
| | | |
| UL File Number | E174545 http://www.ul.com/ Follow link to Certifications, then UL File No., enter E174545 | |
| TÜV Certificate Number | R 02057213 http://www.tuvdotcom.com/ Follow link to "other certificates", enter File No. 2057213 | |

* RoHS Directive 2002/95/EC Jan. 27, 2003 including annex and RoHS Recast 2011/65/EU June 8, 2011.

** Bourns follows the prevailing definition of "halogen free" in the industry. Bourns considers a product to be "halogen free" if (a) the Bromine (Br) content is 900 ppm or less; (b) the Chlorine (Cl) content is 900 ppm or less; and (c) the total Bromine (Br) and Chlorine (Cl) content is 1500 ppm or less. Specifications are subject to change without notice.

The device characteristics and parameters in this data sheet can and do vary in different applications and actual device performance may vary over time. Users should verify actual device performance in their specific applications.

Additional Features

- Resettable circuit protection
- Bulk packaging, tape and reel and Ammo-Pak available on most models

MF-RX/72 Series - PTC Resettable Fuses

BOURNS®

Product Dimensions

| Model | A | | B | | C | | D | | E | | Physical Characteristics | | |
|-------------|------------------|------------------|-----------------|----------------|---------------|----------------|-------|-----------------|----------|--|--------------------------|--|--|
| | Max. | Max. | Nom. | Tol. ± | Min. | Max. | Style | Lead Dia. | Material | | | | |
| MF-RX020/72 | 7.4 (0.291) | 12.7 (0.5) | 5.1 (0.201) | 0.7 (0.028) | 7.6 (0.30) | 3.1 (0.122) | 1 | 0.51 (0.020) | Sn/CuFe | | | | |
| MF-RX025/72 | 7.4 (0.291) | 12.7 (0.5) | 5.1 (0.201) | 0.7 (0.028) | 7.6 (0.30) | 3.1 (0.122) | 1 | 0.51 (0.020) | Sn/CuFe | | | | |
| MF-RX030/72 | 7.4 (0.291) | 13.4 (0.528) | 5.1 (0.201) | 0.7 (0.028) | 7.6 (0.30) | 3.1 (0.122) | 1 | 0.51 (0.020) | Sn/CuFe | | | | |
| MF-RX040/72 | 7.4 (0.291) | 13.7 (0.539) | 5.1 (0.201) | 0.7 (0.028) | 7.6 (0.30) | 3.1 (0.122) | 1 | 0.51 (0.020) | Sn/CuFe | | | | |
| MF-RX050/72 | 7.9 (0.311) | 13.7 (0.539) | 5.1 (0.201) | 0.7 (0.028) | 7.6 (0.30) | 3.1 (0.122) | 1 | 0.51 (0.020) | Sn/Cu | | | | |
| MF-RX065/72 | 9.7 (0.382) | 15.2 (0.598) | 5.1 (0.201) | 0.7 (0.028) | 7.6 (0.30) | 3.1 (0.122) | 1 | 0.51 (0.020) | Sn/Cu | | | | |
| MF-RX075/72 | 10.4 (0.409) | 16.0 (0.630) | 5.1 (0.201) | 0.7 (0.028) | 7.6 (0.30) | 3.1 (0.122) | 1 | 0.51 (0.020) | Sn/Cu | | | | |
| MF-RX090/72 | 11.7 (0.461) | 16.70 (0.657) | 5.1 (0.201) | 0.7 (0.028) | 7.6 (0.30) | 3.1 (0.122) | 1 | 0.51 (0.020) | Sn/Cu | | | | |
| MF-RX110/72 | 10.84 (0.427) | 16.84 (0.662) | 5.1 (0.201) | 0.7 (0.028) | 7.6 (0.30) | 3.1 (0.122) | 2 | 0.81 (0.032) | Sn/Cu | | | | |
| MF-RX135/72 | 12.26 (0.483) | 18.26 (0.718) | 5.1 (0.201) | 0.7 (0.028) | 7.6 (0.30) | 3.1 (0.122) | 2 | 0.81 (0.032) | Sn/Cu | | | | |
| MF-RX160/72 | 13.94 (0.549) | 19.94 (0.785) | 5.1 (0.201) | 0.7 (0.028) | 7.6 (0.30) | 3.1 (0.122) | 2 | 0.81 (0.032) | Sn/Cu | | | | |
| MF-RX185/72 | 15.18 (0.598) | 21.18 (0.833) | 5.1 (0.201) | 0.7 (0.028) | 7.6 (0.30) | 3.1 (0.122) | 2 | 0.81 (0.032) | Sn/Cu | | | | |
| MF-RX250/72 | 17.84 (0.702) | 23.84 (0.938) | 10.2 (0.402) | 0.7 (0.028) | 7.6 (0.30) | 3.1 (0.122) | 2 | 0.81 (0.032) | Sn/Cu | | | | |
| MF-RX300/72 | 20.67 (0.814) | 26.67 (1.050) | 10.2 (0.402) | 0.7 (0.028) | 7.6 (0.30) | 3.1 (0.122) | 2 | 0.81 (0.032) | Sn/Cu | | | | |
| MF-RX375/72 | 23.51 (0.926) | 29.51 (1.161) | 10.2 (0.402) | 0.7 (0.028) | 7.6 (0.30) | 3.1 (0.122) | 2 | 0.81 (0.032) | Sn/Cu | | | | |

Packaging options:

BULK: 500 pcs. per bag.

TAPE & REEL: MF-RX020/72-2 ~ MF-RX090/72-2 = 3000 pcs. per reel; MF-RX110/72-2 ~ MF-RX160/72-2 = 1500 pcs. per reel;
MF-RX185/72-2 - MF-RX375/72-2 = 1000 pcs. per reel.

AMMO-PACK: MF-RX020/72-AP ~ MF-RX090/72-AP = 2000 pcs. per pack; MF-RX110/72-AP ~ MF-RX160/72-AP = 1000 pcs. per pack;
MF-RX185/72-AP - MF-RX375/72-AP = 500 pcs. per pack.

DIMENSIONS: $\frac{\text{MM}}{\text{(INCHES)}}$

Style 1

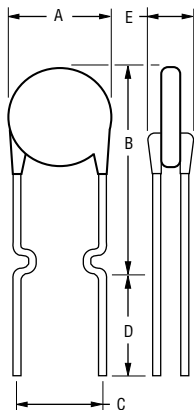

Style 2

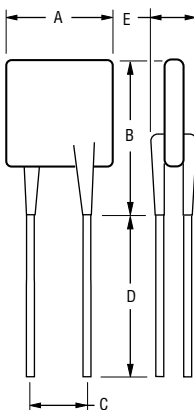

Typical Part Marking

Represents total content. Layout may vary.

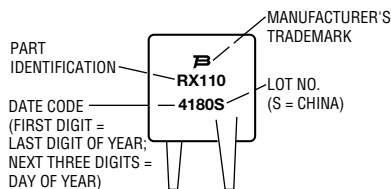

How to Order

MF - RX 110/72 - 2

Multifuse®
Product Designator

Series
RX = Radial Leaded Component

Hold Current, I_{hold}
020-375 (0.20 Amps - 3.75 Amps)

Maximum Voltage, V_{max}
72 (72 Volts)

Packaging Options
- 0 = Bulk Packaging
- 2 = Tape and Reel*
- AP = Ammo-Pak*
*Packaged per EIA 486-B

Specifications are subject to change without notice.
The device characteristics and parameters in this data sheet can and do vary in different applications and actual device performance may vary over time.
Users should verify actual device performance in their specific applications.

MF-RX/72 Series - PTC Resettable Fuses

BOURNS®

Typical Time to Trip at 23 °C

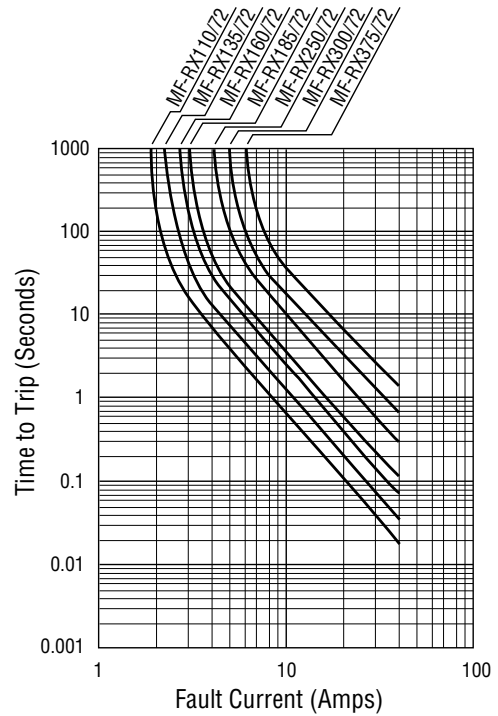
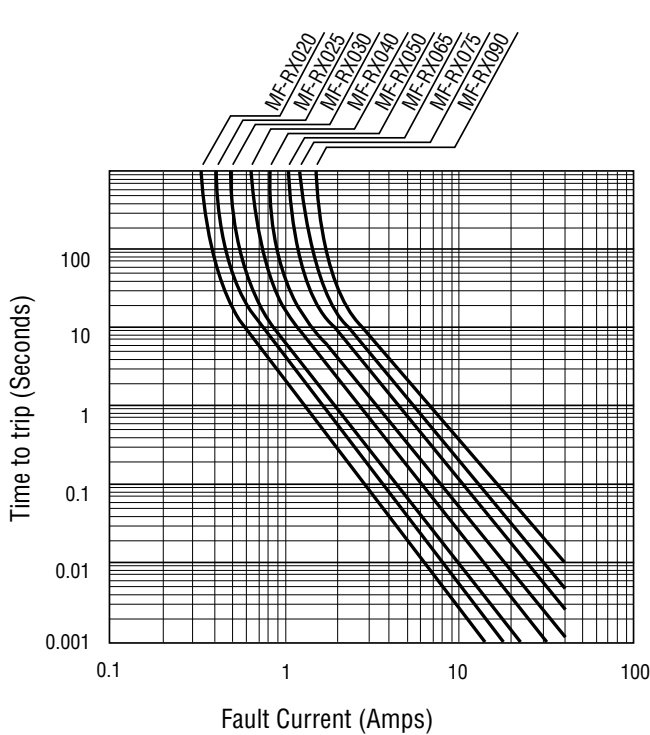

The Time to Trip curves represent typical performance of a device in a simulated application environment. Actual performance in specific customer applications may differ from these values due to the influence of other variables.

Thermal Derating Chart - I_{hold} (Amps)

| Model | Ambient Operating Temperature | | | | | | | | |
|-------------|-------------------------------|--------|------|-------|-------|-------|-------|-------|-------|
| | -40 °C | -20 °C | 0 °C | 23 °C | 40 °C | 50 °C | 60 °C | 70 °C | 85 °C |
| MF-RX020/72 | 0.31 | 0.27 | 0.24 | 0.20 | 0.16 | 0.14 | 0.13 | 0.11 | 0.08 |
| MF-RX025/72 | 0.39 | 0.34 | 0.30 | 0.25 | 0.20 | 0.18 | 0.16 | 0.14 | 0.10 |
| MF-RX030/72 | 0.47 | 0.41 | 0.36 | 0.30 | 0.24 | 0.22 | 0.19 | 0.16 | 0.12 |
| MF-RX040/72 | 0.62 | 0.54 | 0.48 | 0.40 | 0.32 | 0.29 | 0.25 | 0.22 | 0.16 |
| MF-RX050/72 | 0.78 | 0.68 | 0.60 | 0.50 | 0.41 | 0.36 | 0.32 | 0.27 | 0.20 |
| MF-RX065/72 | 1.01 | 0.88 | 0.77 | 0.65 | 0.53 | 0.47 | 0.41 | 0.35 | 0.26 |
| MF-RX075/72 | 1.16 | 1.02 | 0.89 | 0.75 | 0.61 | 0.54 | 0.47 | 0.41 | 0.30 |
| MF-RX090/72 | 1.40 | 1.22 | 1.07 | 0.90 | 0.73 | 0.65 | 0.57 | 0.49 | 0.36 |
| MF-RX110/72 | 1.71 | 1.50 | 1.31 | 1.10 | 0.89 | 0.79 | 0.69 | 0.59 | 0.44 |
| MF-RX135/72 | 2.09 | 1.84 | 1.61 | 1.35 | 1.09 | 0.97 | 0.85 | 0.73 | 0.54 |
| MF-RX160/72 | 2.48 | 2.18 | 1.90 | 1.60 | 1.30 | 1.15 | 1.01 | 0.86 | 0.64 |
| MF-RX185/72 | 2.87 | 2.52 | 2.20 | 1.85 | 1.50 | 1.33 | 1.17 | 1.00 | 0.74 |
| MF-RX250/72 | 3.88 | 3.40 | 2.98 | 2.50 | 2.03 | 1.80 | 1.58 | 1.35 | 1.00 |
| MF-RX300/72 | 4.65 | 4.08 | 3.57 | 3.00 | 2.43 | 2.16 | 1.89 | 1.62 | 1.20 |
| MF-RX375/72 | 5.81 | 5.10 | 4.46 | 3.75 | 3.04 | 2.70 | 2.36 | 2.03 | 1.50 |

MF-RX/72 SERIES, REV. L 07/16

Specifications are subject to change without notice.

The device characteristics and parameters in this data sheet can and do vary in different applications and actual device performance may vary over time. Users should verify actual device performance in their specific applications.

MF-R, MF-R/90, MF-R/600, MF-RX, & MF-RX/72 Series Tape and Reel Specifications

BOURNS®

Devices taped using EIA468-B/IEC286-2 standards. See table below and Figures 1 and 2 for details.

| Dimension Description | IEC Mark | EIA Mark | Dimensions | |
|---|------------|------------|------------------------|------------------------------------|
| | | | Dimensions | Tolerance |
| Carrier tape width | W | W | $\frac{18}{(.709)}$ | $\frac{-0.5/+1.0}{(-0.02/+0.039)}$ |
| Hold down tape width | W_0 | W_4 | $\frac{11}{(.433)}$ | min. |
| Hold down tape | | | No protrusion | |
| Top distance between tape edges | W_2 | W_6 | $\frac{3}{(.118)}$ | max. |
| Sprocket hole position | W_1 | W_5 | $\frac{9}{(.354)}$ | $\frac{-0.5/+0.75}{(-0.02/+0.03)}$ |
| Sprocket hole diameter | D_0 | D_0 | $\frac{4}{(.157)}$ | $\frac{\pm 0.2}{(\pm .0078)}$ |
| Abscissa to plane (straight lead) | H | H | $\frac{18.5}{(.728)}$ | $\frac{\pm 3.0}{(\pm .118)}$ |
| Abscissa to plane (kinked lead) | H_0 | H_0 | $\frac{16}{(.63)}$ | $\frac{\pm 0.5}{(\pm .02)}$ |
| Abscissa to top (straight lead) | H_1 | H_1 | $\frac{38.0}{(1.496)}$ | max. |
| Abscissa to top (kinked lead) | H_1 | H_1 | $\frac{32.2}{(1.268)}$ | max. |
| Overall width w/lead protrusion (straight lead) | | C_1 | $\frac{55.0}{(2.165)}$ | max. |
| Overall width w/lead protrusion (kinked lead) | | C_1 | $\frac{43.2}{(1.7)}$ | max. |
| Overall width w/o lead protrusion (straight lead) | | C_2 | $\frac{54.0}{(2.126)}$ | max. |
| Overall width w/o lead protrusion (kinked lead) | | C_2 | $\frac{42.5}{(1.673)}$ | max. |
| Lead protrusion | l_1 | L_1 | $\frac{1.0}{(.039)}$ | max. |
| Protrusion of cutout | L | L | $\frac{11}{(.433)}$ | max. |
| Protrusion beyond hold-down tape | l_2 | l_2 | Not specified | |
| Sprocket hole pitch | P_0 | P_0 | $\frac{12.7}{(0.5)}$ | $\frac{\pm 0.3}{(\pm .012)}$ |
| Pitch tolerance | | | 20 consecutive | $\frac{\pm 1}{(\pm .039)}$ |
| Device pitch: MF-R005–MF-R160, MF-R/90 | | | $\frac{12.7}{(0.5)}$ | $\frac{\pm 0.3}{(\pm .012)}$ |
| Device pitch: MF-R185–MF-R400, MF-R/600, MF-RX110–MF-RX375, MF-RX110/72–MF-RX375/72 | | | $\frac{25.4}{(1.0)}$ | $\frac{\pm 0.6}{(\pm .024)}$ |
| Tape thickness | t | t | $\frac{0.9}{(.035)}$ | max. |
| Tape thickness with splice: MF-R010–MF-R160, MF-RX110/72–MF-RX185/72 | | t_1 | $\frac{1.5}{(.059)}$ | max. |
| Tape thickness with splice: MF-R250–MF-R1100, MF-RX110–MF-RX375, MF-R/90, MF-RX250/72–MF-RX375/72 | | t_1 | $\frac{2.3}{(.091)}$ | max. |
| Splice sprocket hole alignment | | | 0 | $\frac{\pm 0.3}{(\pm .012)}$ |
| Body lateral deviation | Δ_h | Δ_h | 0 | $\frac{\pm 1.0}{(\pm .039)}$ |
| Body tape plane deviation | Δ_p | Δ_p | 0 | $\frac{\pm 1.3}{(\pm .051)}$ |

DIMENSIONS: $\frac{\text{MM}}{\text{(INCHES)}}$

Specifications are subject to change without notice.

The device characteristics and parameters in this data sheet can and do vary in different applications and actual device performance may vary over time. Users should verify actual device performance in their specific applications.

MF-R, MF-R/90, MF-R/600, MF-RX, & MF-RX/72 Series Tape and Reel Specifications

BOURNS®

| Dimension Description | IEC Mark | EIA Mark | Dimensions | |
|--|----------------------|----------------------|--|-------------------------------|
| | | | Dimensions | Tolerance |
| Lead spacing: MF-R, MF-R/90, MF-R/600, MF-RX, MF-RX/72 | <i>F</i> | <i>F</i> | $\frac{5.08}{(0.2)}$ | $\frac{\pm 0.2}{(\pm 0.008)}$ |
| Reel width | <i>w</i> | <i>W₂</i> | $\frac{56.0}{(2.205)}$ | max. |
| Reel diameter | <i>d</i> | <i>a</i> | $\frac{370.0}{(14.57)}$ | max. |
| Space between flanges less device | <i>W₁</i> | <i>h</i> | $\frac{4.75}{(.187)}$ | $\frac{\pm 3.25}{(\pm .128)}$ |
| Arbor hole diameter | <i>f</i> | <i>c</i> | $\frac{26.0}{(1.024)}$ | $\frac{\pm 12.0}{(\pm .472)}$ |
| Core diameter: MF-R, MF-RX, MF-R/90 | <i>h</i> | <i>n</i> | $\frac{80}{(3.15)}$ | max. |
| Core diameter: MF-R/600 | <i>h</i> | <i>n</i> | $\frac{91}{(3.58)}$ | max. |
| Box: MF-R, MF-RX, MF-R/90 | | | $\frac{62}{(2.44)}$ $\frac{355}{(14.0)}$ $\frac{345}{(13.6)}$ | nom. |
| Box: MF-R/600 | | | $\frac{64}{(2.52)}$ $\frac{372}{(14.6)}$ $\frac{362}{(14.25)}$ | max. |
| Consecutive missing places: MF-R, MF-RX, MF-R/90 | | | 3 | max. |
| Consecutive missing places: MF-R/600 | | | none | |
| Empty places per reel: MF-R, MF-RX, MF-R/90 | | | Not specified | |
| Empty places per reel: MF-R/600 | | | 0.1 % | |

**Taped Component Dimensions -
Figure 1**

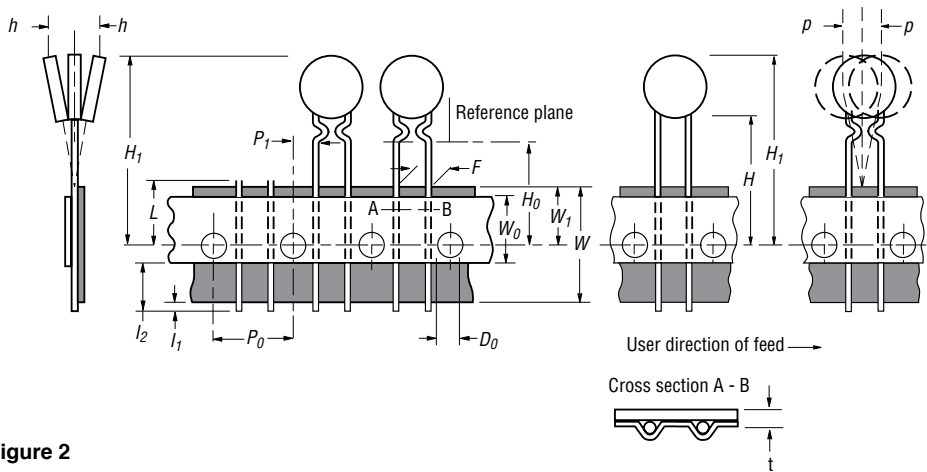

Reel Dimensions - Figure 2

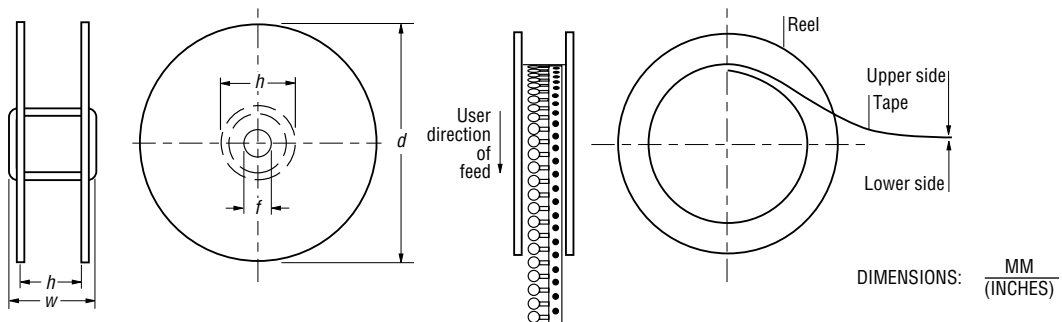

Specifications are subject to change without notice.
The device characteristics and parameters in this data sheet can and do vary in different applications and actual device performance may vary over time.
Users should verify actual device performance in their specific applications.