

FDG6332C_F085

20V N & P-Channel PowerTrench® MOSFETs

Features

- **Q1** 0.7 A, 20V. $R_{DS(ON)} = 300\text{ m}\Omega @ V_{GS} = 4.5\text{ V}$
 $R_{DS(ON)} = 400\text{ m}\Omega @ V_{GS} = 2.5\text{ V}$
- **Q2** -0.6 A, -20V. $R_{DS(ON)} = 420\text{ m}\Omega @ V_{GS} = -4.5\text{ V}$
 $R_{DS(ON)} = 630\text{ m}\Omega @ V_{GS} = -2.5\text{ V}$
- Low gate charge
- High performance trench technology for extremely low $R_{DS(ON)}$
- SC70-6 package: small footprint (51% smaller than SSOT-6); low profile (1mm thick)
- Qualified to AEC Q101
- RoHS Compliant

General Description

The N & P-Channel MOSFETs are produced using Fairchild Semiconductor's advanced PowerTrench process that has been especially tailored to minimize on-state resistance and yet maintain superior switching performance.

These devices have been designed to offer exceptional power dissipation in a very small footprint for applications where the bigger more expensive TSSOP-8 and SSOP-6 packages are impractical.

Applications

- DC/DC converter
- Load switch
- LCD display inverter

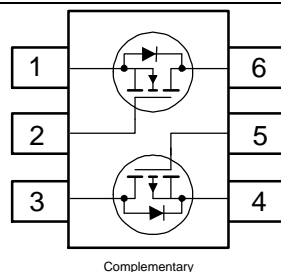
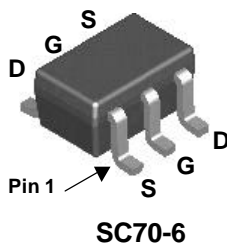

Absolute Maximum Ratings T_A=25°C unless otherwise noted

Symbol	Parameter	Q1	Q2	Units
V _{DSS}	Drain-Source Voltage	20	-20	V
V _{GSS}	Gate-Source Voltage	±12	±12	V
I _D	Drain Current – Continuous (Note 1)	0.7	-0.6	A
	– Pulsed	2.1	-2	
P _D	Power Dissipation for Single Operation (Note 1)	0.3		W
T _J , T _{STG}	Operating and Storage Junction Temperature Range	-55 to +150		°C

Thermal Characteristics

R _{θJA}	Thermal Resistance, Junction-to-Ambient (Note 1)	415	°C/W
------------------	--	-----	------

Package Marking and Ordering Information

Device Marking	Device	Reel Size	Tape width	Quantity
.32	FDG6332C_F085	7"	8mm	3000 units

Electrical Characteristics

T_A = 25°C unless otherwise noted

Symbol	Parameter	Test Conditions	Min	Typ	Max	Units	
Off Characteristics							
BV _{DSS}	Drain–Source Breakdown Voltage	V _{GS} = 0 V, I _D = 250 μA V _{GS} = 0 V, I _D = -250 μA	Q1 Q2	20 -20		V	
$\frac{\Delta BV_{DSS}}{\Delta T_J}$	Breakdown Voltage Temperature Coefficient	I _D = 250 μA, Ref. to 25°C I _D = -250 μA, Ref. to 25°C	Q1 Q2		14 -14	mV/°C	
I _{DSS}	Zero Gate Voltage Drain Current	V _{DS} = 16 V, V _{GS} = 0 V V _{DS} = -16 V, V _{GS} = 0 V	Q1 Q2		1 -1	μA	
I _{GSSF} / I _{GSSR}	Gate–Body Leakage, Forward	V _{GS} = ± 12 V, V _{DS} = 0 V			±100	nA	
I _{GSSF} / I _{GSSR}	Gate–Body Leakage, Reverse	V _{GS} = ± 12 V, V _{DS} = 0 V			±100	nA	
On Characteristics (Note 2)							
V _{GS(th)}	Gate Threshold Voltage	Q1 V _{DS} = V _{GS} , I _D = 250 μA Q2 V _{DS} = V _{GS} , I _D = -250 μA		0.6 -0.6	1.1 -1.2	1.5 -1.5	V
$\frac{\Delta V_{GS(th)}}{\Delta T_J}$	Gate Threshold Voltage Temperature Coefficient	Q1 I _D = 250 μA, Ref. To 25°C Q2 I _D = -250 μA, Ref. to 25°C			-2.8 3		mV/°C
R _{DS(on)}	Static Drain–Source On–Resistance	Q1 V _{GS} = 4.5 V, I _D = 0.7 A V _{GS} = 2.5 V, I _D = 0.6 A V _{GS} = 4.5 V, I _D = 0.7 A, T _J = 125°C Q2 V _{GS} = -4.5 V, I _D = -0.6 A V _{GS} = -2.5 V, I _D = -0.5 A V _{GS} = -4.5 V, I _D = -0.6 A, T _J = 125°C			180 293 247	300 400 442	mΩ
g _{FS}	Forward Transconductance	Q1 V _{DS} = 5 V, I _D = 0.7 A Q2 V _{DS} = -5 V, I _D = -0.6 A			2.8 1.8		S
I _{D(on)}	On–State Drain Current	Q1 V _{GS} = 4.5 V, V _{DS} = 5 V Q2 V _{GS} = -4.5 V, V _{DS} = -5 V		1 -2			A
Dynamic Characteristics							
C _{iss}	Input Capacitance	Q1 V _{DS} = 10 V, V _{GS} = 0 V, f = 1.0 MHz Q2 V _{DS} = -10 V, V _{GS} = 0 V, f = 1.0 MHz			113 114		pF
C _{oss}	Output Capacitance	Q1 V _{DS} = 10 V, V _{GS} = 0 V, f = 1.0 MHz Q2 V _{DS} = -10 V, V _{GS} = 0 V, f = 1.0 MHz			34 24		pF
C _{rss}	Reverse Transfer Capacitance	Q1 V _{DS} = 10 V, V _{GS} = 0 V, f = 1.0 MHz Q2 V _{DS} = -10 V, V _{GS} = 0 V, f = 1.0 MHz			16 9		pF
Switching Characteristics (Note 2)							
t _{d(on)}	Turn–On Delay Time	Q1 For Q1: V _{DS} = 10 V, I _D = 1 A V _{GS} = 4.5 V, R _{GEN} = 6 Ω Q2 For Q2: V _{DS} = -10 V, I _D = -1 A V _{GS} = -4.5 V, R _{GEN} = 6 Ω			5 5.5	10 11	ns
t _r	Turn–On Rise Time				7 14	15 25	ns
t _{d(off)}	Turn–Off Delay Time				9 6	18 12	ns
t _f	Turn–Off Fall Time				1.5 1.7	3 3.4	ns
Q _g	Total Gate Charge	Q1 For Q1: V _{DS} = 10 V, I _D = 0.7 A Q2 V _{GS} = 4.5 V, R _{GEN} = 6 Ω			1.1 1.4	1.5 2	nC
Q _{gs}	Gate–Source Charge	Q1 For Q1: V _{DS} = 10 V, I _D = 0.7 A Q2 V _{GS} = 4.5 V, R _{GEN} = 6 Ω			0.24 0.3		nC
Q _{gd}	Gate–Drain Charge	Q1 V _{DS} = -10 V, I _D = -0.6 A Q2 V _{GS} = -4.5 V, R _{GEN} = 6 Ω			0.3 0.4		nC

Electrical Characteristics

$T_A = 25^\circ\text{C}$ unless otherwise noted

Symbol	Parameter	Test Conditions	Min	Typ	Max	Units	
Drain–Source Diode Characteristics and Maximum Ratings							
I_S	Maximum Continuous Drain–Source Diode Forward Current	Q1			0.25	A	
		Q2			–0.25		
V_{SD}	Drain–Source Diode Forward Voltage	Q1	$V_{GS} = 0\text{ V}, I_S = 0.25\text{ A}$ (Note 2)		0.74	1.2	V
		Q2	$V_{GS} = 0\text{ V}, I_S = -0.25\text{ A}$ (Note 2)		–0.77	–1.2	

Notes:

1. $R_{\theta JA}$ is the sum of the junction-to-case and case-to-ambient thermal resistance where the case thermal reference is defined as the solder mounting surface of the drain pins. $R_{\theta JC}$ is guaranteed by design while $R_{\theta JA}$ is determined by the user's board design. $R_{\theta JA} = 415^\circ\text{C/W}$ when mounted on a minimum pad of FR-4 PCB in a still air environment.

2. Pulse Test: Pulse Width < 300 μs , Duty Cycle < 2.0%

Typical Characteristics: N-Channel

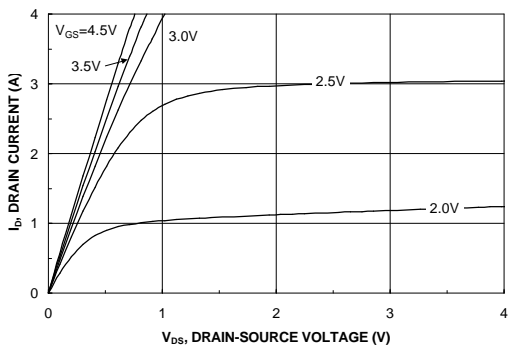

Figure 1. On-Region Characteristics.

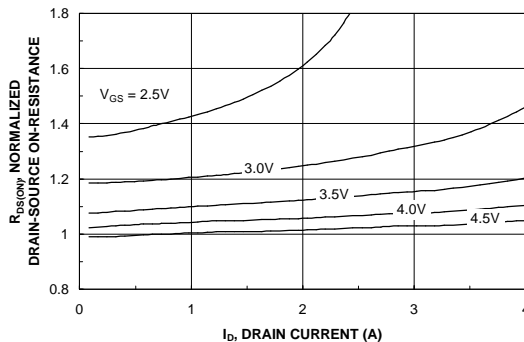

Figure 2. On-Resistance Variation with Drain Current and Gate Voltage.

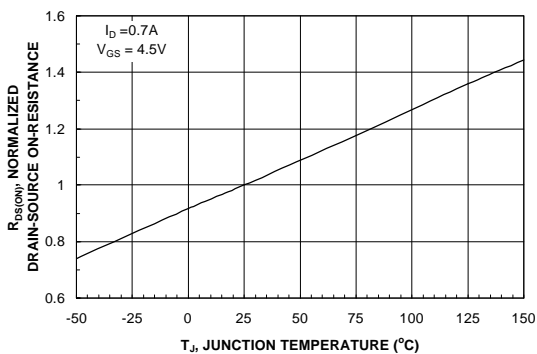

Figure 3. On-Resistance Variation with Temperature.

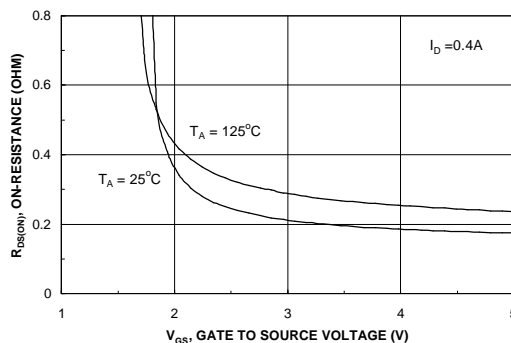

Figure 4. On-Resistance Variation with Gate-to-Source Voltage.

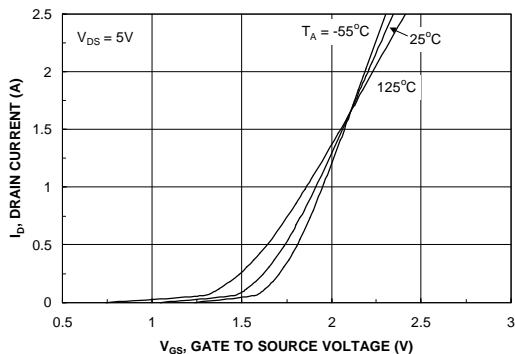

Figure 5. Transfer Characteristics.

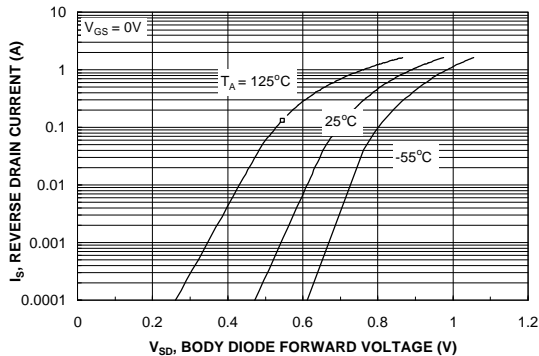

Figure 6. Body Diode Forward Voltage Variation with Source Current and Temperature.

Typical Characteristics: N-Channel

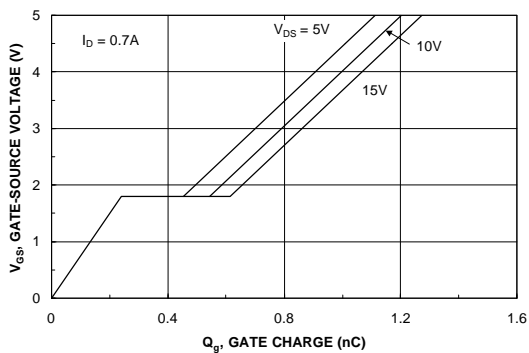

Figure 7. Gate Charge Characteristics.

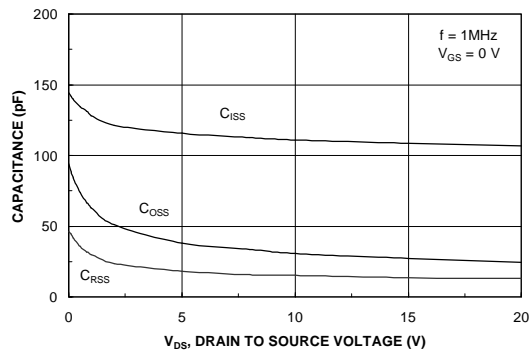

Figure 8. Capacitance Characteristics.

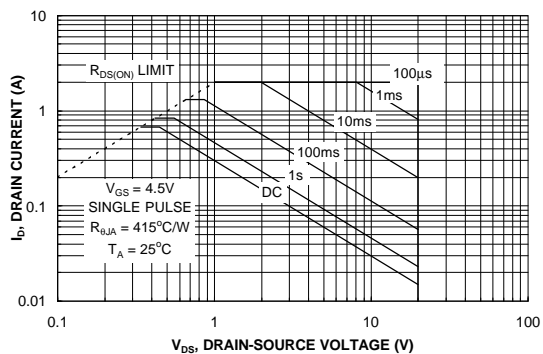

Figure 9. Maximum Safe Operating Area.

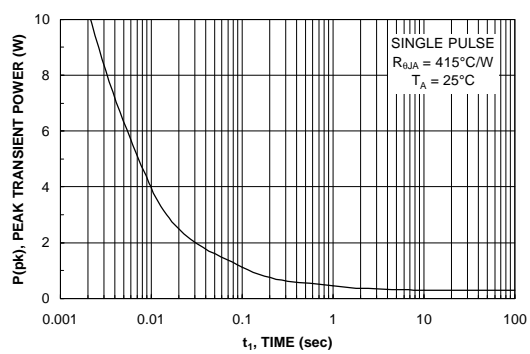

Figure 10. Single Pulse Maximum Power Dissipation.

Typical Characteristics: P-Channel

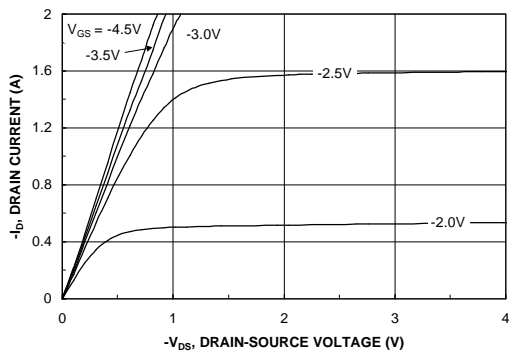

Figure 11. On-Region Characteristics.

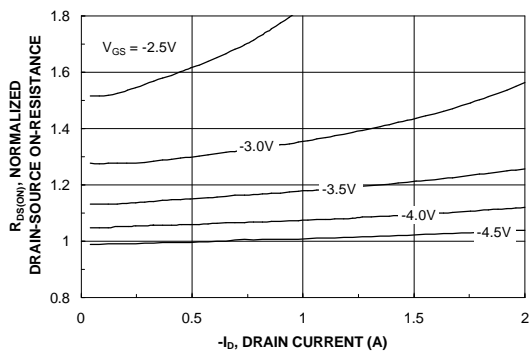

Figure 12. On-Resistance Variation with Drain Current and Gate Voltage.

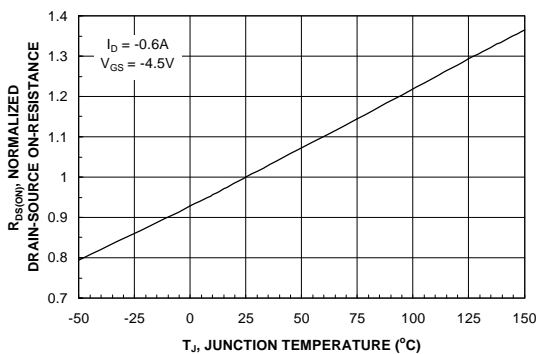

Figure 13. On-Resistance Variation with Temperature.

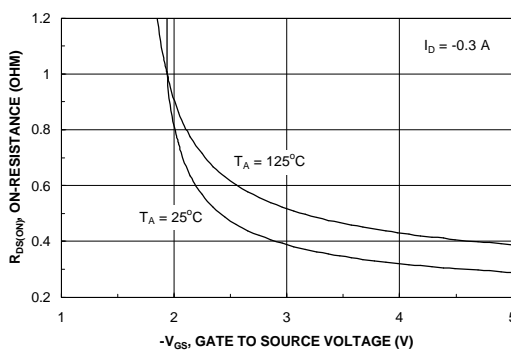

Figure 14. On-Resistance Variation with Gate-to-Source Voltage.

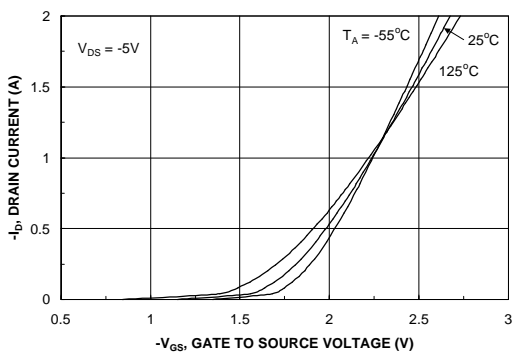

Figure 15. Transfer Characteristics.

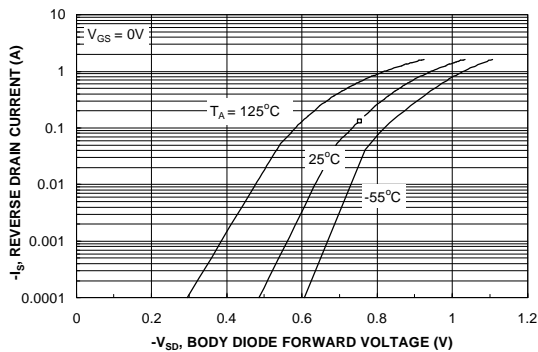

Figure 16. Body Diode Forward Voltage Variation with Source Current and Temperature.

Typical Characteristics: P-Channel

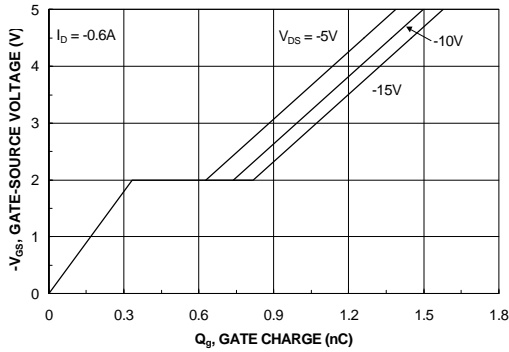

Figure 17. Gate Charge Characteristics.

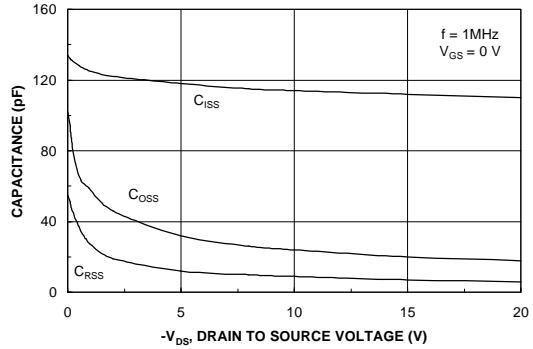

Figure 18. Capacitance Characteristics.

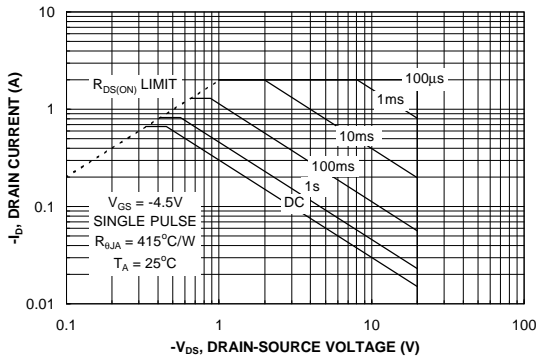

Figure 19. Maximum Safe Operating Area.

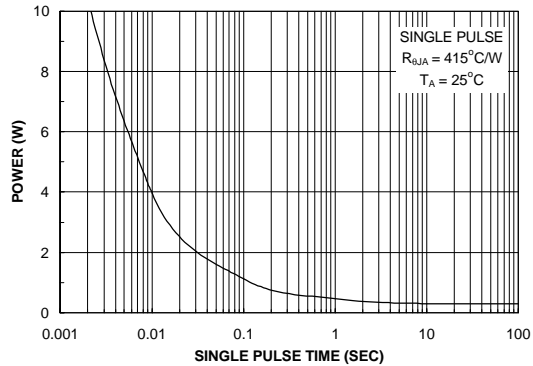

Figure 20. Single Pulse Maximum Power Dissipation.

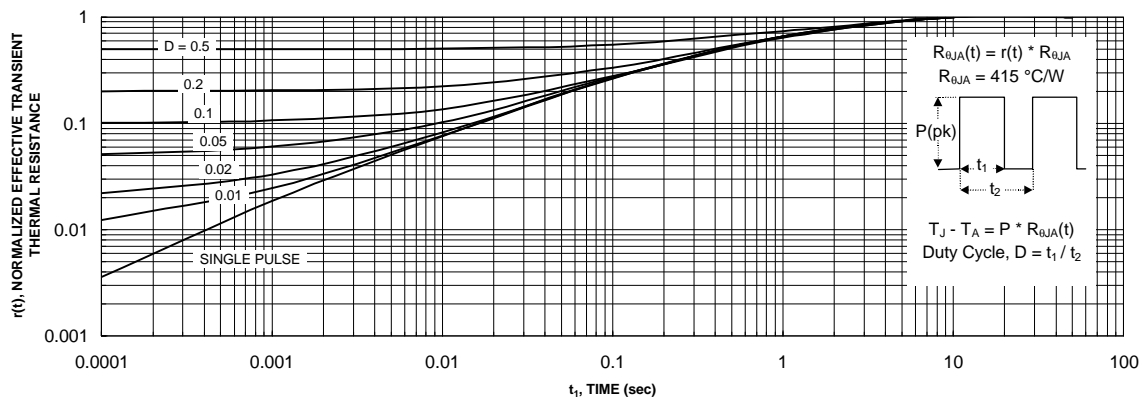
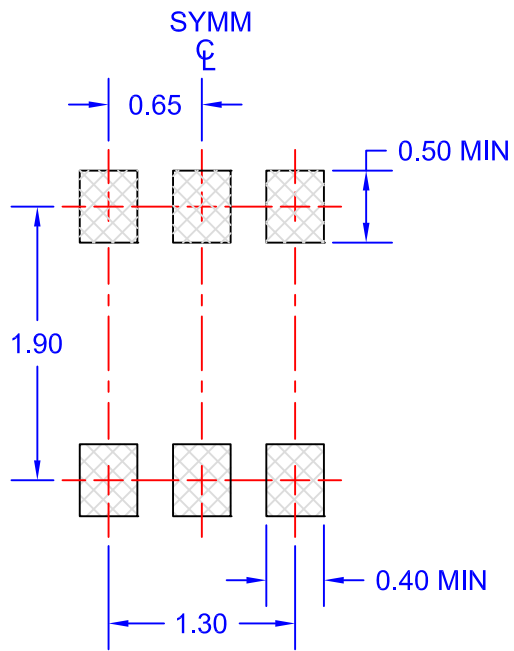
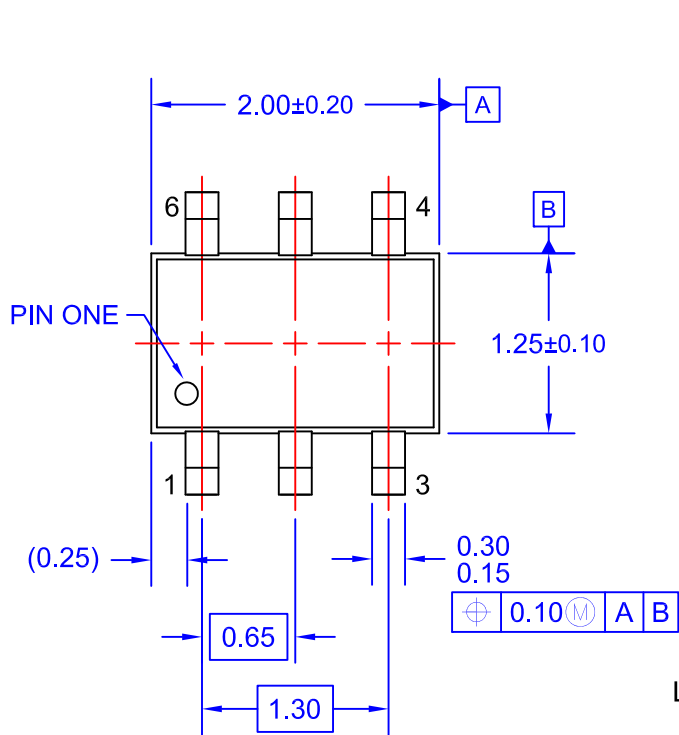
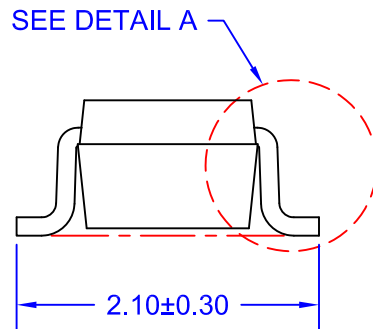
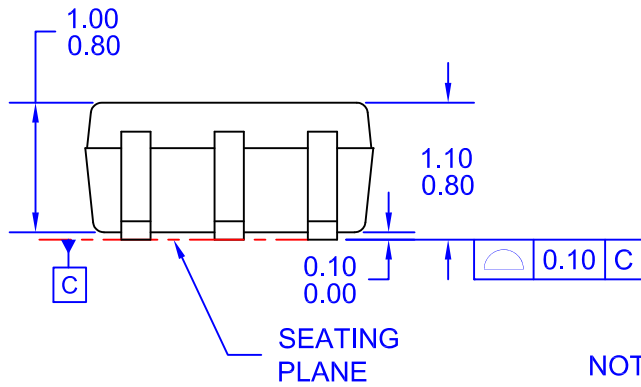

Figure 21. Transient Thermal Response Curve.

Thermal characterization performed using the conditions described in Note 1. Transient thermal response will change depending on the circuit board design.



LAND PATTERN RECOMMENDATION



- NOTES: UNLESS OTHERWISE SPECIFIED
- A) THIS PACKAGE CONFORMS TO EIAJ SC-88, 1996.
 - B) ALL DIMENSIONS ARE IN MILLIMETERS.
 - C) DIMENSIONS DO NOT INCLUDE BURRS OR MOLD FLASH.
 - D) DIMENSIONING AND TOLERANCING PER ASME Y14.5M-2009
 - E) DRAWING FILENAME: MKT-MAA06AREV7

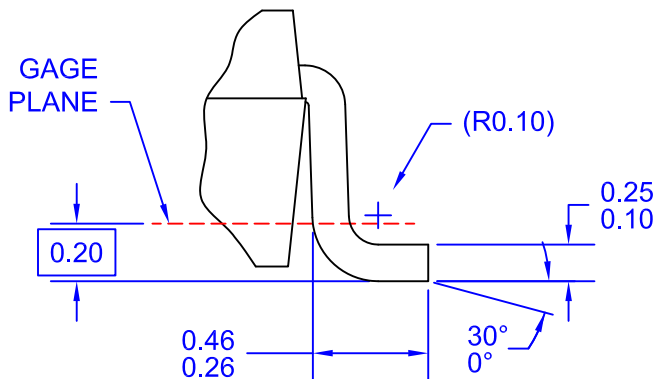





DETAIL A
SCALE: 60X





TRADEMARKS

The following includes registered and unregistered trademarks and service marks, owned by Fairchild Semiconductor and/or its global subsidiaries, and is not intended to be an exhaustive list of all such trademarks.

- AccuPower™
- AttitudeEngine™
- Awinda®
- AX-CAP®*
- BitSiC™
- Build it Now™
- CorePLUS™
- CorePOWER™
- CROSSVOL™
- CTL™
- Current Transfer Logic™
- DEUXPEED®
- Dual Cool™
- EcoSPARK®
- EfficientMax™
- ESBC™
- F**™
- Fairchild®
- Fairchild Semiconductor®
- FACT Quiet Series™
- FACT®
- FastvCore™
- FETBench™
- FPS™
- F-PFS™
- FRFET®
- Global Power ResourceSM
- GreenBridge™
- Green FPS™
- Green FPS™ e-Series™
- Gmax™
- GTO™
- IntelliMAX™
- ISOPLANAR™
- Making Small Speakers Sound Louder and Better™
- MegaBuck™
- MICROCOUPLER™
- MicroFET™
- MicroPak™
- MicroPak2™
- MillerDrive™
- MotionMax™
- MotionGrid®
- MTi®
- MTx®
- MVN®
- mWSaver®
- OptoHiT™
- OPTOLOGIC®
- OPTOPLANAR®
- ®
- Power Supply WebDesigner™
- PowerTrench®
- PowerXS™
- Programmable Active Droop™
- QFET®
- QS™
- Quiet Series™
- RapidConfigure™
- ™
- Saving our world, 1mW/W/kW at a time™
- SignalWise™
- SmartMax™
- SMART START™
- Solutions for Your Success™
- SPM®
- STEALTH™
- SuperFET®
- SuperSOT™-3
- SuperSOT™-6
- SuperSOT™-8
- SupreMOS®
- SyncFET™
- Sync-Lock™
- ®
- TinyBoost®
- TinyBuck®
- TinyCalc™
- TinyLogic®
- TINYOPTO™
- TinyPower™
- TinyPWM™
- TinyWire™
- TranSiC™
- TriFault Detect™
- TRUECURRENT®*
- μSerDes™
- ™
- UHC®
- Ultra FRFET™
- UniFET™
- VcX™
- VisualMax™
- VoltagePlus™
- XS™
- Xsens™
- 仙童®

* Trademarks of System General Corporation, used under license by Fairchild Semiconductor.

DISCLAIMER

FAIRCHILD SEMICONDUCTOR RESERVES THE RIGHT TO MAKE CHANGES WITHOUT FURTHER NOTICE TO ANY PRODUCTS HEREIN TO IMPROVE RELIABILITY, FUNCTION, OR DESIGN. TO OBTAIN THE LATEST, MOST UP-TO-DATE DATASHEET AND PRODUCT INFORMATION, VISIT OUR WEBSITE AT [HTTP://WWW.FAIRCHILDSEMI.COM](http://www.fairchildsemi.com). FAIRCHILD DOES NOT ASSUME ANY LIABILITY ARISING OUT OF THE APPLICATION OR USE OF ANY PRODUCT OR CIRCUIT DESCRIBED HEREIN; NEITHER DOES IT CONVEY ANY LICENSE UNDER ITS PATENT RIGHTS, NOR THE RIGHTS OF OTHERS. THESE SPECIFICATIONS DO NOT EXPAND THE TERMS OF FAIRCHILD'S WORLDWIDE TERMS AND CONDITIONS, SPECIFICALLY THE WARRANTY THEREIN, WHICH COVERS THESE PRODUCTS.

AUTHORIZED USE

Unless otherwise specified in this data sheet, this product is a standard commercial product and is not intended for use in applications that require extraordinary levels of quality and reliability. This product may not be used in the following applications, unless specifically approved in writing by a Fairchild officer: (1) automotive or other transportation, (2) military/aerospace, (3) any safety critical application – including life critical medical equipment – where the failure of the Fairchild product reasonably would be expected to result in personal injury, death or property damage. Customer's use of this product is subject to agreement of this Authorized Use policy. In the event of an unauthorized use of Fairchild's product, Fairchild accepts no liability in the event of product failure. In other respects, this product shall be subject to Fairchild's Worldwide Terms and Conditions of Sale, unless a separate agreement has been signed by both Parties.

ANTI-COUNTERFEITING POLICY

Fairchild Semiconductor Corporation's Anti-Counterfeiting Policy. Fairchild's Anti-Counterfeiting Policy is also stated on our external website, www.fairchildsemi.com, under Terms of Use

Counterfeiting of semiconductor parts is a growing problem in the industry. All manufacturers of semiconductor products are experiencing counterfeiting of their parts. Customers who inadvertently purchase counterfeit parts experience many problems such as loss of brand reputation, substandard performance, failed applications, and increased cost of production and manufacturing delays. Fairchild is taking strong measures to protect ourselves and our customers from the proliferation of counterfeit parts. Fairchild strongly encourages customers to purchase Fairchild parts either directly from Fairchild or from Authorized Fairchild Distributors who are listed by country on our web page cited above. Products customers buy either from Fairchild directly or from Authorized Fairchild Distributors are genuine parts, have full traceability, meet Fairchild's quality standards for handling and storage and provide access to Fairchild's full range of up-to-date technical and product information. Fairchild and our Authorized Distributors will stand behind all warranties and will appropriately address any warranty issues that may arise. Fairchild will not provide any warranty coverage or other assistance for parts bought from Unauthorized Sources. Fairchild is committed to combat this global problem and encourage our customers to do their part in stopping this practice by buying direct or from authorized distributors.

PRODUCT STATUS DEFINITIONS

Definition of Terms

Datasheet Identification	Product Status	Definition
Advance Information	Formative / In Design	Datasheet contains the design specifications for product development. Specifications may change in any manner without notice.
Preliminary	First Production	Datasheet contains preliminary data; supplementary data will be published at a later date. Fairchild Semiconductor reserves the right to make changes at any time without notice to improve design.
No Identification Needed	Full Production	Datasheet contains final specifications. Fairchild Semiconductor reserves the right to make changes at any time without notice to improve the design.
Obsolete	Not In Production	Datasheet contains specifications on a product that is discontinued by Fairchild Semiconductor. The datasheet is for reference information only.