

### FEATURES

- Input voltage range: 2.3 V to 5.5 V**
- One 1.2 A buck regulator**
- Two 300 mA LDOs**
- 20-lead, 4 mm × 4 mm LFCSP package**
- Overcurrent and thermal protection**
- Soft start**
- Undervoltage lockout**
- Buck key specifications**
  - Output voltage range: 0.8 V to 3.8 V**
  - Current mode topology for excellent transient response**
  - 3 MHz operating frequency**
  - Peak efficiency up to 96%**
  - Uses tiny multilayer inductors and capacitors**
  - Mode pin selects forced PWM or auto PWM/PSM modes**
  - 100% duty cycle low dropout mode**
- LDOs key specifications**
  - Output voltage range: 0.8 V to 5.2 V**
  - Low  $V_{IN}$  from 1.7 V to 5.5 V**
  - Stable with 2.2  $\mu\text{F}$  ceramic output capacitors**
  - High PSRR**
  - Low output noise**
  - Low dropout voltage**
  - 40°C to +125°C junction temperature range**

### GENERAL DESCRIPTION

The ADP5040 combines one high performance buck regulator and two low dropout regulators (LDO) in a small 20-lead LFCSP to meet demanding performance and board space requirements.

The high switching frequency of the buck regulator enables the use of tiny multilayer external components and minimizes board space.

When the MODE pin is set to logic high, the buck regulator operates in forced pulse width modulation (PWM) mode. When the MODE pin is set to logic low, the buck regulator operates in PWM mode when the load is around the nominal value. When the load current falls below a predefined threshold the regulator operates in power save mode (PSM) improving the light-load efficiency. The low quiescent current, low dropout voltage, and wide input voltage range of the ADP5040 LDOs extend the battery life of portable devices. The ADP5040 LDOs maintain a power supply rejection greater than 60 dB for frequencies as high as 10 kHz while operating with a low headroom voltage.

Each regulator in the ADP5040 is activated by a high level on the respective enable pin. The output voltages of the regulators are programmed through external resistor dividers to address a variety of applications.

### FUNCTIONAL BLOCK DIAGRAM

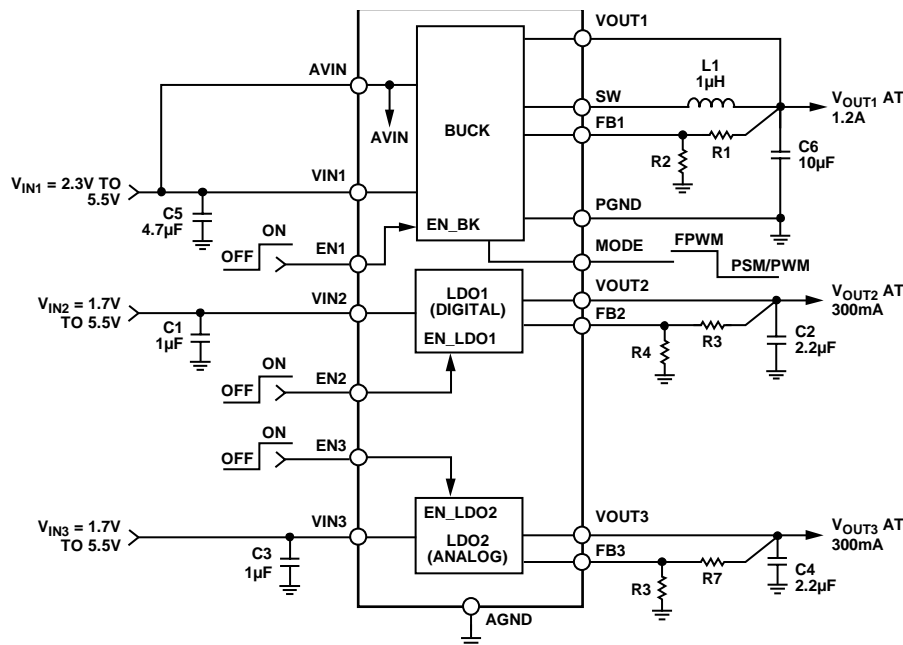

Figure 1.

Rev. A

[Document Feedback](#)

Information furnished by Analog Devices is believed to be accurate and reliable. However, no responsibility is assumed by Analog Devices for its use, nor for any infringements of patents or other rights of third parties that may result from its use. Specifications subject to change without notice. No license is granted by implication or otherwise under any patent or patent rights of Analog Devices. Trademarks and registered trademarks are the property of their respective owners.

One Technology Way, P.O. Box 9106, Norwood, MA 02062-9106, U.S.A.  
 Tel: 781.329.4700 ©2011–2014 Analog Devices, Inc. All rights reserved.  
[Technical Support](#) [www.analog.com](http://www.analog.com)

# ADP5040\* Product Page Quick Links

Last Content Update: 08/30/2016

---

## [Comparable Parts](#)

View a parametric search of comparable parts

## [Evaluation Kits](#)

- [ADP5040 Evaluation Board](#)

## [Documentation](#)

### **Data Sheet**

- [ADP5040: Micro PMU with 1.2A Buck Regulator and Two 300 mA LDOs Data Sheet](#)

## [Tools and Simulations](#)

- [5V uPMU BuckDesigner](#)
- [ADIsimPower™ Voltage Regulator Design Tool](#)

## [Reference Materials](#)

### **Press**

- [Multi-output Regulators with Supervisory and Watchdog Timers Reduce Component Count, Increase Power Density and Reliability](#)

### **Solutions Bulletins & Brochures**

- [Integrated Power Solutions for Altera FPGAs](#)
- [Integrated, High Power Solutions for Xilinx FPGAs](#)

### **Technical Articles**

- [Isolation Architecture, Circuit, and Component Selection in Power Inverter Applications](#)

## [Design Resources](#)

- [ADP5040 Material Declaration](#)
- [PCN-PDN Information](#)
- [Quality And Reliability](#)
- [Symbols and Footprints](#)

## [Discussions](#)

View all ADP5040 EngineerZone Discussions

## [Sample and Buy](#)

Visit the product page to see pricing options

## [Technical Support](#)

Submit a technical question or find your regional support number

---

\* This page was dynamically generated by Analog Devices, Inc. and inserted into this data sheet. Note: Dynamic changes to the content on this page does not constitute a change to the revision number of the product data sheet. This content may be frequently modified.

**TABLE OF CONTENTS**

Features .....	1	Power Management Unit.....	25
General Description .....	1	Buck Section.....	26
Functional Block Diagram .....	1	LDO Section .....	27
Revision History .....	2	Applications Information .....	29
Specifications.....	3	Buck External Component Selection.....	29
General Specifications .....	3	LDO External Component Selection .....	30
Buck Specifications.....	3	Power Dissipation/Thermal Considerations .....	31
LDO1, LDO2 Specifications .....	4	Application Diagram .....	33
Input and Output Capacitor, Recommended Specifications..	5	PCB Layout Guidelines.....	34
Absolute Maximum Ratings.....	6	Suggested Layout .....	34
Thermal Resistance .....	6	Bill of Materials.....	35
ESD Caution.....	6	Factory Programmable Options .....	36
Pin Configuration and Function Descriptions.....	7	Outline Dimensions .....	37
Typical Performance Characteristics .....	8	Ordering Guide .....	37
Theory of Operation .....	25		

**REVISION HISTORY**

**1/14—Rev. 0 to Rev. A**

Change to Figure 1 .....	1
Change to Figure 106 .....	30
Change to Figure 108 .....	33
Change to Figure 109 .....	34

**12/11—Revision 0: Initial Version**

## SPECIFICATIONS

### GENERAL SPECIFICATIONS

AVIN, VIN1 = 2.3 V to 5.5 V; AVIN, VIN1 ≥ VIN2, VIN3; VIN2, VIN3 = 1.7 V to 5.5 V, T<sub>J</sub> = -40°C to +125°C for minimum/maximum specifications, and T<sub>A</sub> = 25°C for typical specifications, unless otherwise noted.

Table 1.

Parameter	Symbol	Description	Min	Typ	Max	Unit
AVIN UNDERVOLTAGE LOCKOUT	UVLO <sub>AVIN</sub>					
Input Voltage Rising	UVLO <sub>AVINRISE</sub>					
Option 0					2.275	V
Option 1					3.9	V
Input Voltage Falling	UVLO <sub>AVINFALL</sub>					
Option 0			1.95			V
Option 1			3.1			V
SHUTDOWN CURRENT	I <sub>GND-SD</sub>	ENx = GND		0.1	2	μA
Thermal Shutdown Threshold	TS <sub>SD</sub>	T <sub>J</sub> rising		150		°C
Thermal Shutdown Hysteresis	TS <sub>SD-HYS</sub>			20		°C
START-UP TIME <sup>1</sup>						
BUCK	t <sub>START1</sub>			250		μs
LDO1, LDO2	t <sub>START2</sub>	V <sub>OUT2</sub> , V <sub>OUT3</sub> = 3.3 V		85		μs
Enx, MODE, INPUTS						
Input Logic High	V <sub>IH</sub>	2.5 V ≤ AVIN ≤ 5.5 V	1.2			V
Input Logic Low	V <sub>IL</sub>	2.5 V ≤ AVIN ≤ 5.5 V			0.4	V
Input Leakage Current	V <sub>I-LEAKAGE</sub>	ENx = AVIN or GND		0.05	1	μA

<sup>1</sup> Start-up time is defined as the time from the moment EN1 = EN2 = EN3 transfers from 0 V to V<sub>AVIN</sub> to the moment V<sub>OUT1</sub>, V<sub>OUT2</sub>, and V<sub>OUT3</sub> reach 90% of their nominal level. Start-up times are shorter for individual channels if another channel is already enabled. See the Typical Performance Characteristics section for more information.

### BUCK SPECIFICATIONS

AVIN, VIN1 = 2.3 V to 5.5 V; V<sub>OUT1</sub> = 1.8 V; L = 1 μH; C<sub>IN</sub> = 10 μF; C<sub>OUT</sub> = 10 μF; T<sub>J</sub> = -40°C to +125°C for minimum/maximum specifications, and T<sub>A</sub> = 25°C for typical specifications, unless otherwise noted.<sup>1</sup>

Table 2.

Parameter	Symbol	Test Conditions/Comments	Min	Typ	Max	Unit
INPUT CHARACTERISTICS						
Input Voltage Range	V <sub>IN1</sub>		2.3		5.5	V
OUTPUT CHARACTERISTICS						
Output Voltage Accuracy	V <sub>OUT1</sub>	PWM mode, I <sub>LOAD</sub> = 0 mA to 1200 mA	-3		+3	%
Line Regulation	(ΔV <sub>OUT1</sub> /V <sub>OUT1</sub> )/ΔV <sub>IN1</sub>	PWM mode		-0.05		%/V
Load Regulation	(ΔV <sub>OUT1</sub> /V <sub>OUT1</sub> )/ΔI <sub>OUT1</sub>	I <sub>LOAD</sub> = mA to 1200 mA, PWM mode		-0.1		%/A
VOLTAGE FEEDBACK	V <sub>FB1</sub>		0.485	0.5	0.515	V
PWM TO POWER SAVE MODE CURRENT THRESHOLD	I <sub>PSM-L</sub>			100		mA
INPUT CURRENT CHARACTERISTICS						
DC Operating Current	I <sub>NOLOAD</sub>	MODE = ground I <sub>LOAD</sub> = 0 mA, device not switching, all other channels disabled		21	35	μA
Shutdown Current	I <sub>SHTD</sub>	EN1 = 0 V, T <sub>A</sub> = T <sub>J</sub> = -40°C to +125°C		0.2	1.0	μA

Parameter	Symbol	Test Conditions/Comments	Min	Typ	Max	Unit
SW CHARACTERISTICS						
SW On Resistance	R <sub>PFET</sub>	PFET, AVIN = VIN1 = 3.6 V		180	240	mΩ
		PFET, AVIN = VIN1 = 5 V		140	190	mΩ
	R <sub>NFET</sub>	NFET, AVIN = VIN1 = 3.6 V		170	235	mΩ
		NFET, AVIN = VIN1 = 5 V		150	210	mΩ
Current Limit	I <sub>LIMIT</sub>	PFET switch peak current limit	1600	1950	2300	mA
ACTIVE PULL-DOWN		EN1 = 0 V		85		Ω
OSCILLATOR FREQUENCY	F <sub>OSC</sub>		2.5	3.0	3.5	MHz

<sup>1</sup> All limits at temperature extremes are guaranteed via correlation using standard statistical quality control (SQC).

## LDO1, LDO2 SPECIFICATIONS

V<sub>IN2</sub>, V<sub>IN3</sub> = (V<sub>OUT2</sub>, V<sub>OUT3</sub> + 0.5 V) or 1.7 V (whichever is greater) to 5.5 V; AVIN, VIN1 ≥ VIN2, VIN3; C<sub>IN</sub> = 1 μF, C<sub>OUT</sub> = 2.2 μF; T<sub>J</sub> = -40°C to +125°C for minimum/maximum specifications, and T<sub>A</sub> = 25°C for typical specifications, unless otherwise noted. <sup>1</sup>

Table 3.

Parameter	Symbol	Conditions	Min	Typ	Max	Unit
INPUT VOLTAGE RANGE	V <sub>IN2</sub> , V <sub>IN3</sub>	T <sub>J</sub> = -40°C to +125°C	1.7		5.5	V
OPERATING SUPPLY CURRENT						
Bias Current per LDO <sup>2</sup>	I <sub>VIN2BIAS</sub> / I <sub>VIN3BIAS</sub>	I <sub>OUT3</sub> = I <sub>OUT4</sub> = 0 μA		10	30	μA
		I <sub>OUT2</sub> = I <sub>OUT3</sub> = 10 mA		60	100	μA
		I <sub>OUT2</sub> = I <sub>OUT3</sub> = 300 mA		165	245	μA
Total System Input Current	I <sub>IN</sub>	Includes all current into AVIN, VIN1, VIN2 and VIN3				
LDO1 or LDO2 Only		I <sub>OUT2</sub> = I <sub>OUT3</sub> = 0 μA, all other channels disabled		53		μA
LDO1 and LDO2 Only		I <sub>OUT2</sub> = I <sub>OUT3</sub> = 0 μA, buck disabled		74		μA
OUTPUT VOLTAGE ACCURACY	V <sub>OUT2</sub> , V <sub>OUT3</sub>	100 μA < I <sub>OUT2</sub> < 300 mA, 100 μA < I <sub>OUT3</sub> < 300 mA V <sub>IN2</sub> = (V <sub>OUT2</sub> + 0.5 V) to 5.5 V, V <sub>IN3</sub> = (V <sub>OUT3</sub> + 0.5 V) to 5.5 V	-3		+3	%
REFERENCE VOLTAGE	V <sub>FB2</sub> , V <sub>FB3</sub>		0.485	0.500	0.515	V
REGULATION						
Line Regulation	(ΔV <sub>OUT2</sub> /V <sub>OUT2</sub> )/ΔV <sub>IN2</sub> (ΔV <sub>OUT3</sub> /V <sub>OUT3</sub> )/ΔV <sub>IN3</sub>	V <sub>IN2</sub> = (V <sub>OUT2</sub> + 0.5 V) to 5.5 V V <sub>IN3</sub> = (V <sub>OUT3</sub> + 0.5 V) to 5.5 V I <sub>OUT2</sub> = I <sub>OUT3</sub> = 1 mA	-0.03		+0.03	%/V
Load Regulation <sup>3</sup>	(ΔV <sub>OUT2</sub> /V <sub>OUT2</sub> )/ΔI <sub>OUT2</sub> (ΔV <sub>OUT3</sub> /V <sub>OUT3</sub> )/ΔI <sub>OUT3</sub>	I <sub>OUT2</sub> = I <sub>OUT3</sub> = 1 mA to 300 mA		0.002	0.0075	%/mA
DROPOUT VOLTAGE <sup>4</sup>	V <sub>DROPOUT</sub>	V <sub>OUT2</sub> = V <sub>OUT3</sub> = 5.0 V, I <sub>OUT2</sub> = I <sub>OUT3</sub> = 300 mA V <sub>OUT2</sub> = V <sub>OUT3</sub> = 3.3 V, I <sub>OUT2</sub> = I <sub>OUT3</sub> = 300 mA V <sub>OUT2</sub> = V <sub>OUT3</sub> = 2.5 V, I <sub>OUT2</sub> = I <sub>OUT3</sub> = 300 mA V <sub>OUT2</sub> = V <sub>OUT3</sub> = 1.8 V, I <sub>OUT2</sub> = I <sub>OUT3</sub> = 300 mA		72	140	mV
				86		mV
				107		mV
				180		mV
ACTIVE PULL-DOWN	R <sub>PDLDO</sub>	EN2/EN3 = 0 V		600		Ω
CURRENT-LIMIT THRESHOLD <sup>5</sup>	I <sub>LIMIT</sub>	T <sub>J</sub> = -40°C to +125°C	335	470		mA
OUTPUT NOISE	OUT <sub>LDO2</sub> NOISE	10 Hz to 100 kHz, V <sub>IN3</sub> = 5 V, V <sub>OUT3</sub> = 3.3 V 10 Hz to 100 kHz, V <sub>IN3</sub> = 5 V, V <sub>OUT3</sub> = 2.8 V 10 Hz to 100 kHz, V <sub>IN3</sub> = 5 V, V <sub>OUT3</sub> = 1.5 V		123		μV rms
				110		μV rms
				59		μV rms
	OUT <sub>LDO1</sub> NOISE	10 Hz to 100 kHz, V <sub>IN2</sub> = 5 V, V <sub>OUT2</sub> = 3.3 V 10 Hz to 100 kHz, V <sub>IN2</sub> = 5 V, V <sub>OUT2</sub> = 2.8 V 10 Hz to 100 kHz, V <sub>IN2</sub> = 5 V, V <sub>OUT2</sub> = 1.5 V		140		μV rms
				129		μV rms
				66		μV rms

Parameter	Symbol	Conditions	Min	Typ	Max	Unit
POWER SUPPLY REJECTION RATIO	PSRR	1 kHz, $V_{IN2}, V_{IN3} = 3.3\text{ V}$ , $V_{OUT2}, V_{OUT3} = 2.8\text{ V}$ , $I_{OUT} = 100\text{ mA}$		66		dB
		100 kHz, $V_{IN2}, V_{IN3} = 3.3\text{ V}$ , $V_{OUT2}, V_{OUT3} = 2.8\text{ V}$ , $I_{OUT} = 100\text{ mA}$		57		dB
		1 MHz, $V_{IN2}, V_{IN3} = 3.3\text{ V}$ , $V_{OUT2}, V_{OUT3} = 2.8\text{ V}$ , $I_{OUT} = 100\text{ mA}$		60		dB

<sup>1</sup> All limits at temperature extremes are guaranteed via correlation using standard statistical quality control (SQC).

<sup>2</sup> This is the input current into  $V_{IN2}$  and  $V_{IN3}$ , which is not delivered to the output load.

<sup>3</sup> Based on an end-point calculation using 1 mA and 300 mA loads.

<sup>4</sup> Dropout voltage is defined as the input-to-output voltage differential when the input voltage is set to the nominal output voltage. This applies only for output voltages above 1.7 V.

<sup>5</sup> Current-limit threshold is defined as the current at which the output voltage drops to 90% of the specified typical value. For example, the current limit for a 3.0 V output voltage is defined as the current that causes the output voltage to drop to 90% of 3.0 V, or 2.7 V.

## INPUT AND OUTPUT CAPACITOR, RECOMMENDED SPECIFICATIONS

Table 4.

Parameter	Symbol	Conditions	Min	Typ	Max	Unit
INPUT CAPACITANCE (BUCK) <sup>1</sup>	$C_{MIN1}$	$T_J = -40^\circ\text{C to } +125^\circ\text{C}$	4.7		40	$\mu\text{F}$
OUTPUT CAPACITANCE (BUCK) <sup>2</sup>	$C_{MIN2}$	$T_J = -40^\circ\text{C to } +125^\circ\text{C}$	7		40	$\mu\text{F}$
INPUT AND OUTPUT CAPACITANCE <sup>3</sup> (LDO1, LDO2)	$C_{MIN34}$	$T_J = -40^\circ\text{C to } +125^\circ\text{C}$	0.70			$\mu\text{F}$
CAPACITOR ESR	$R_{ESR}$	$T_J = -40^\circ\text{C to } +125^\circ\text{C}$	0.001		1	$\Omega$

<sup>1</sup> The minimum input capacitance should be greater than 4.7  $\mu\text{F}$  over the full range of operating conditions. The full range of operating conditions in the application must be considered during device selection to ensure that the minimum capacitance specification is met. X7R and X5R type capacitors are recommended, whereas Y5V and Z5U capacitors are not recommended for use with the buck.

<sup>2</sup> The minimum output capacitance should be greater than 7  $\mu\text{F}$  over the full range of operating conditions. The full range of operating conditions in the application must be considered during device selection to ensure that the minimum capacitance specification is met. X7R and X5R type capacitors are recommended, whereas Y5V and Z5U capacitors are not recommended for use with the buck.

<sup>3</sup> The minimum input and output capacitance should be greater than 0.70  $\mu\text{F}$  over the full range of operating conditions. The full range of operating conditions in the application must be considered during device selection to ensure that the minimum capacitance specification is met. X7R and X5R type capacitors are recommended, whereas Y5V and Z5U capacitors are not recommended for use with LDOs.

## ABSOLUTE MAXIMUM RATINGS

Table 5.

Parameter	Rating
AVIN to AGND	−0.3 V to +6 V
VIN1 to AVIN	−0.3 V to +0.3 V
PGND to AGND	−0.3 V to +0.3 V
VIN2, VIN3, VOUTx, ENx, MODE, FBx, SW to AGND	−0.3 V to (AVIN + 0.3 V)
SW to PGND	−0.3 V to (VIN1 + 0.3 V)
Storage Temperature Range	−65°C to +150°C
Operating Junction Temperature Range	−40°C to +125°C
Soldering Conditions	JEDEC J-STD-020
ESD Human Body Model	3000 V
ESD Charged Device Model	1500 V
ESD Machine Model	200 V

Stresses above those listed under Absolute Maximum Ratings may cause permanent damage to the device. This is a stress rating only; functional operation of the device at these or any other conditions above those indicated in the operational section of this specification is not implied. Exposure to absolute maximum rating conditions for extended periods may affect device reliability.

## THERMAL RESISTANCE

$\theta_{JA}$  is specified for the worst-case conditions, that is, a device soldered in a circuit board for surface-mount packages.

Table 6. Thermal Resistance

Package Type	$\theta_{JA}$	$\theta_{JC}$	Unit
20-Lead, 0.5 mm pitch LFCSP	38	4.2	°C/W

## ESD CAUTION



**ESD (electrostatic discharge) sensitive device.** Charged devices and circuit boards can discharge without detection. Although this product features patented or proprietary protection circuitry, damage may occur on devices subjected to high energy ESD. Therefore, proper ESD precautions should be taken to avoid performance degradation or loss of functionality.





TYPICAL PERFORMANCE CHARACTERISTICS

VIN1 = VIN2 = VIN3 = AVIN = 5.0 V, TA = 25°C, unless otherwise noted.

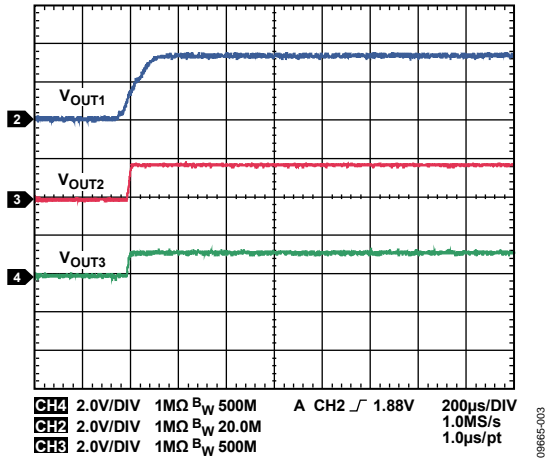

Figure 3. 3-Channel Start-Up Waveforms

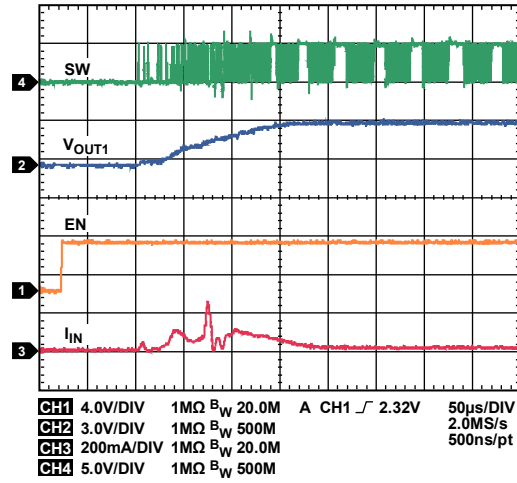

Figure 6. Buck Startup, VOUT1 = 3.3 V, IOUT = 20 mA

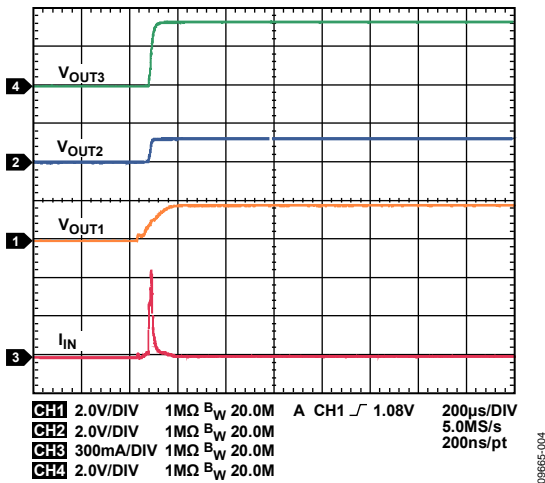

Figure 4. Total Inrush Current, All Channels Started Simultaneously

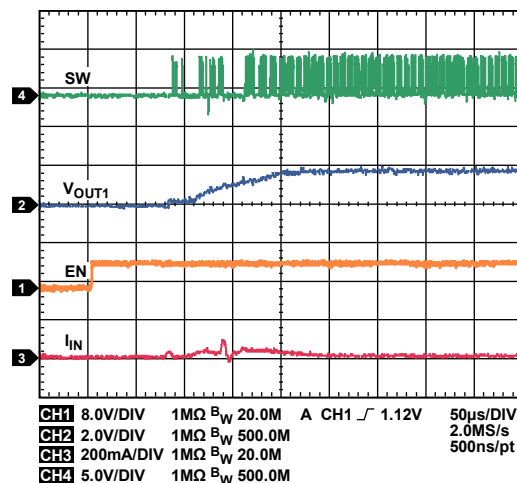

Figure 7. Buck Startup, VOUT1 = 1.8 V, IOUT = 20 mA

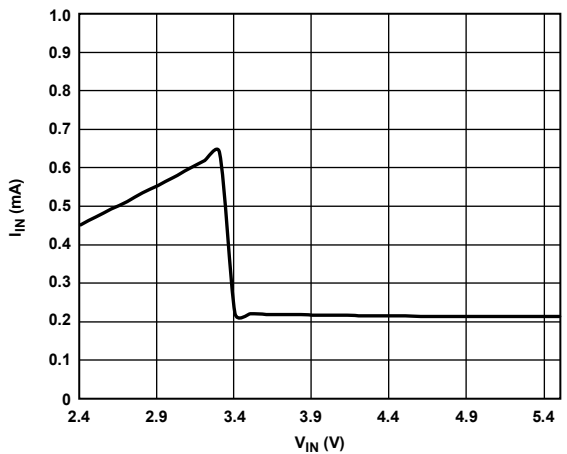

Figure 5. System Quiescent Current (Sum of All the Input Currents) vs. Input Voltage  
 VOUT1 = 1.8 V, VOUT2 = VOUT3 = 3.3 V (UVLO = 3.3 V)

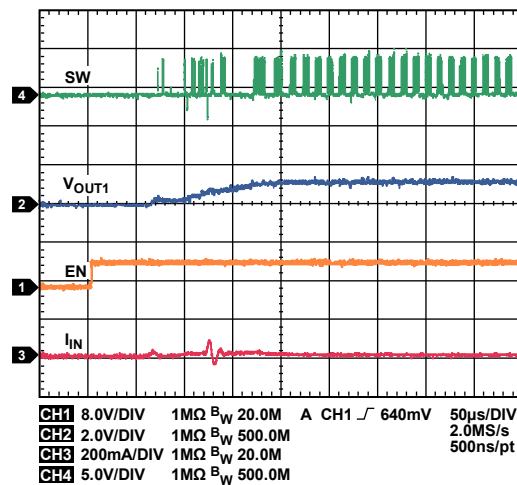

Figure 8. Buck Startup, VOUT1 = 1.2 V, IOUT = 20 mA

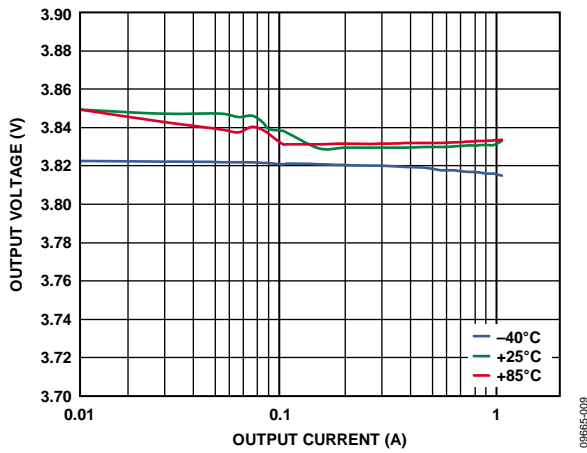

Figure 9. Buck Load Regulation Across Temperature,  $V_{OUT1} = 3.8\text{ V}$ , Auto Mode

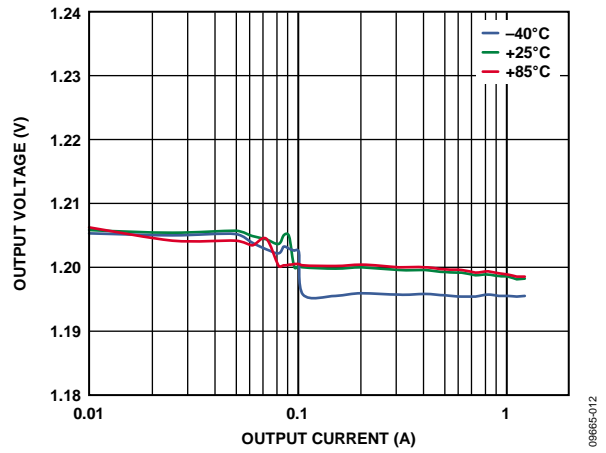

Figure 12. Buck Load Regulation Across Temperature,  $V_{OUT1} = 1.2\text{ V}$ , Auto Mode

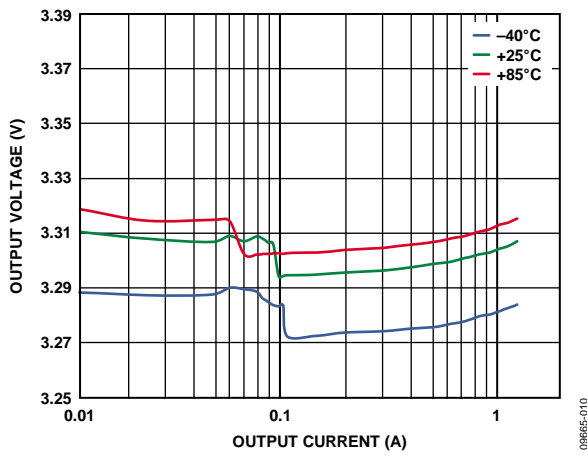

Figure 10. Buck Load Regulation Across Temperature,  $V_{OUT1} = 3.3\text{ V}$ , Auto Mode

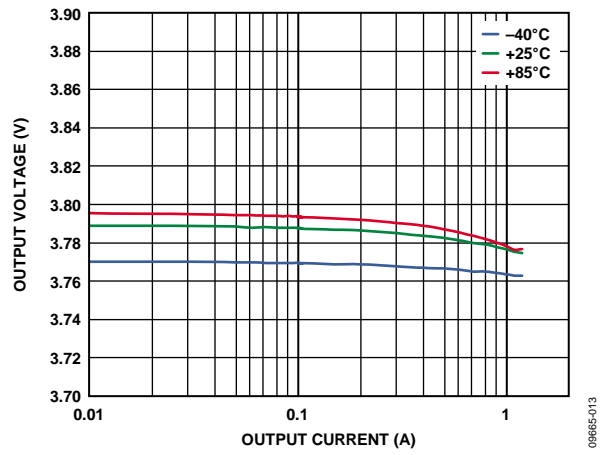

Figure 13. Buck Load Regulation Across Temperature,  $V_{OUT1} = 3.8\text{ V}$ , PWM Mode

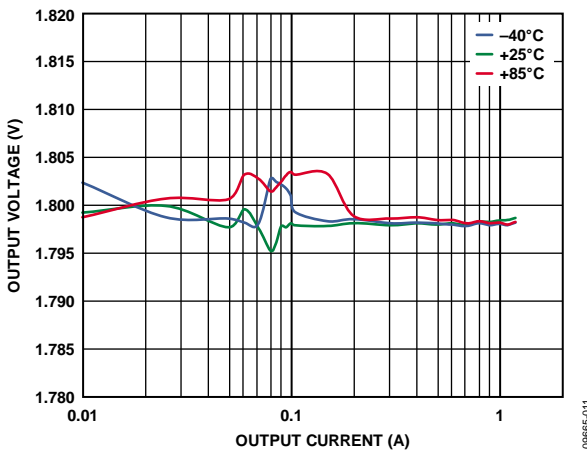

Figure 11. Buck Load Regulation Across Temperature,  $V_{OUT1} = 1.8\text{ V}$ , Auto Mode

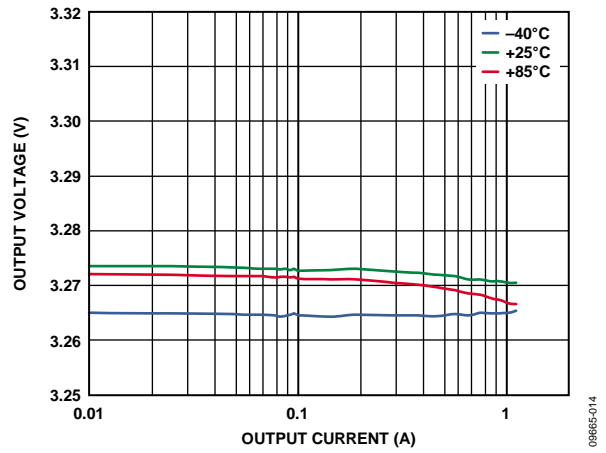

Figure 14. Buck Load Regulation Across Temperature,  $V_{OUT1} = 3.3\text{ V}$ , PWM Mode

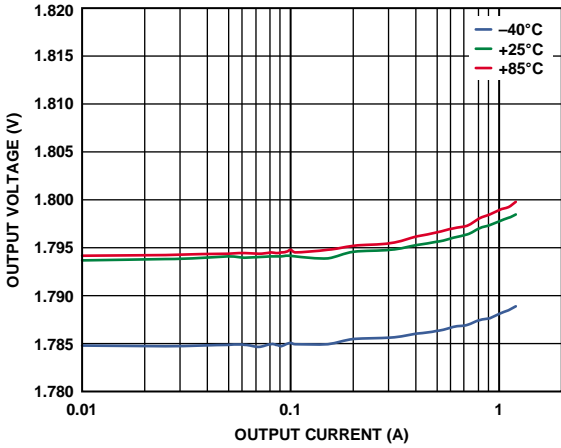

Figure 15. Buck Load Regulation Across Temperature,  $V_{OUT1} = 1.8V$ , PWM Mode

09665-015

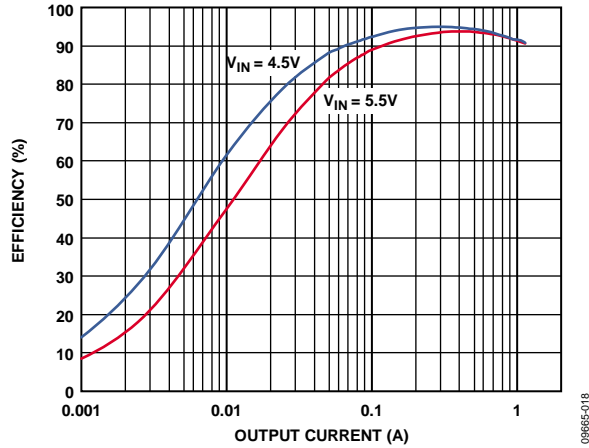

Figure 18. Buck Efficiency vs. Load Current, Across Input Voltage,  $V_{OUT1} = 3.8V$ , PWM Mode

09665-016

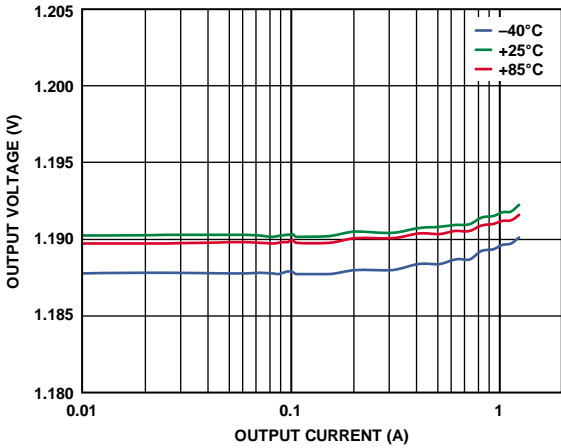

Figure 16. Buck Load Regulation Across Temperature,  $V_{OUT1} = 1.2V$ , PWM Mode

09665-016

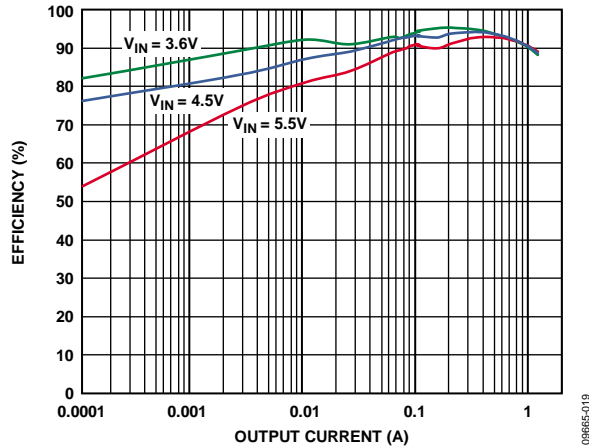

Figure 19. Buck Efficiency vs. Load Current, Across Input Voltage,  $V_{OUT1} = 3.3V$ , Auto Mode

09665-019

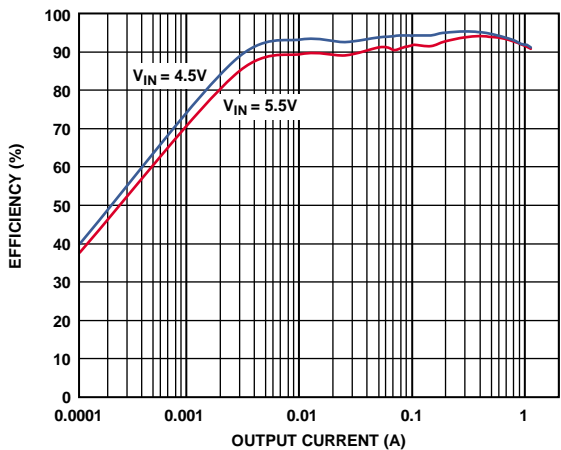

Figure 17. Buck Efficiency vs. Load Current, Across Input Voltage,  $V_{OUT1} = 3.8V$ , Auto Mode

09665-017

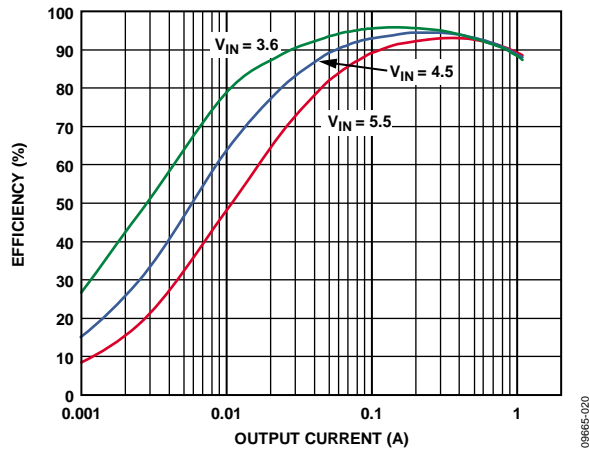

Figure 20. Buck Efficiency vs. Load Current, Across Input Voltage,  $V_{OUT1} = 3.3V$ , PWM Mode

09665-020

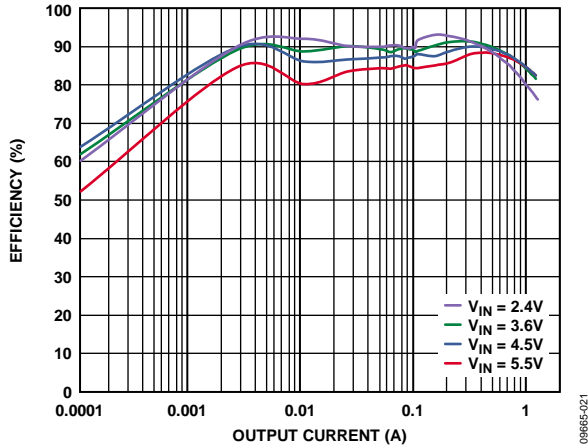

Figure 21. Buck Efficiency vs. Load Current, Across Input Voltage,  $V_{OUT1} = 1.8\text{ V}$ , Auto Mode

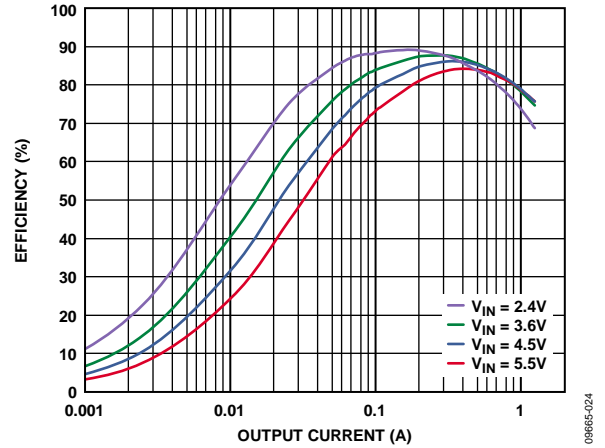

Figure 24. Buck Efficiency vs. Load Current, Across Input Voltage,  $V_{OUT1} = 1.2\text{ V}$ , PWM Mode

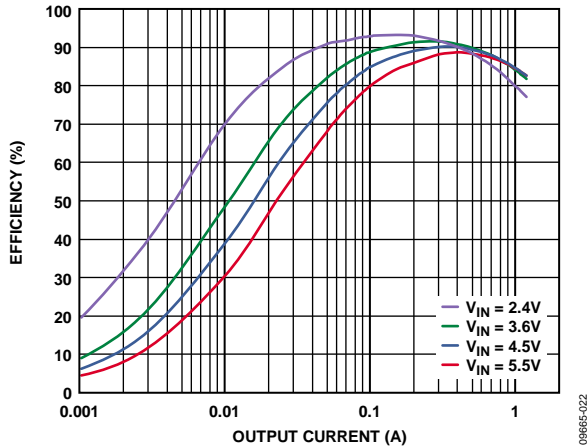

Figure 22. Buck Efficiency vs. Load Current, Across Input Voltage,  $V_{OUT1} = 1.8\text{ V}$ , PWM Mode

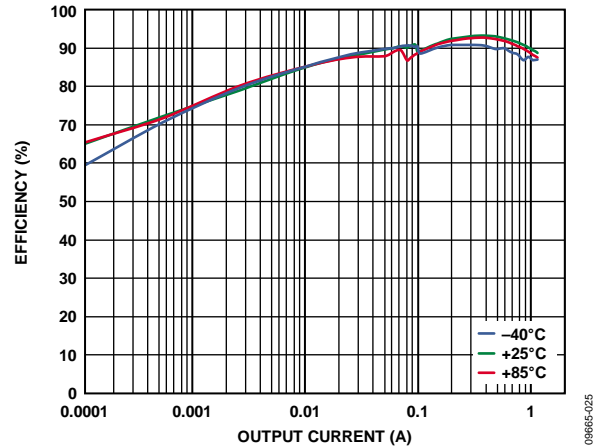

Figure 25. Buck Efficiency vs. Load Current, Across Temperature,  $V_{IN} = 5.0\text{ V}$ ,  $V_{OUT1} = 3.3\text{ V}$ , Auto Mode

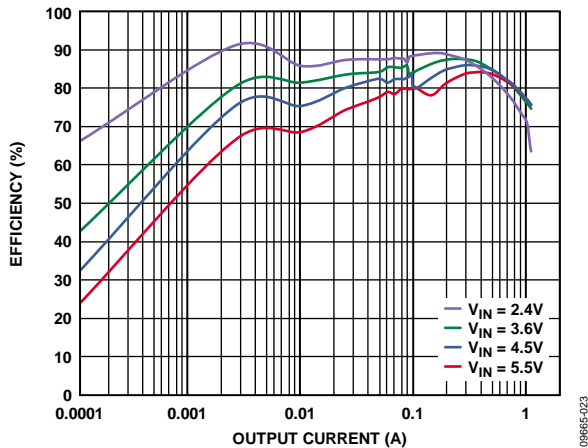

Figure 23. Buck Efficiency vs. Load Current, Across Input Voltage,  $V_{OUT1} = 1.2\text{ V}$ , Auto Mode

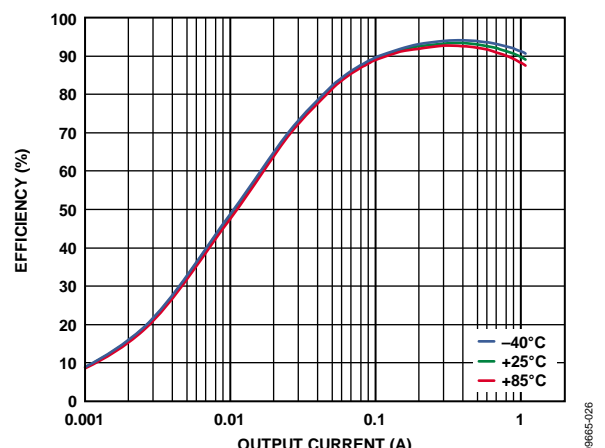

Figure 26. Buck Efficiency vs. Load Current, Across Temperature,  $V_{IN} = 5.0\text{ V}$ ,  $V_{OUT1} = 3.3\text{ V}$ , PWM Mode

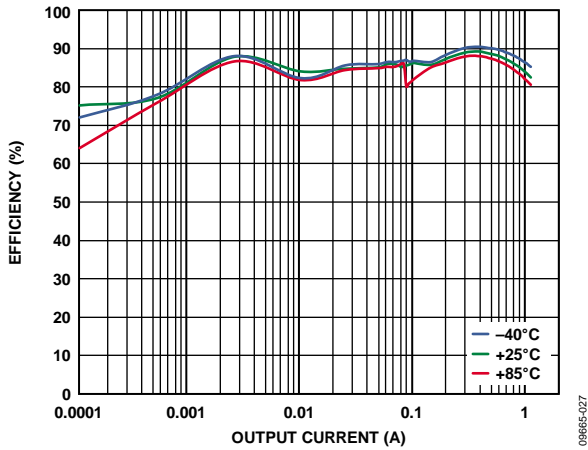

Figure 27. Buck Efficiency vs. Load Current, Across Temperature,  $V_{IN} = 5.0\text{ V}$ ,  $V_{OUT1} = 1.8\text{ V}$ , Auto Mode

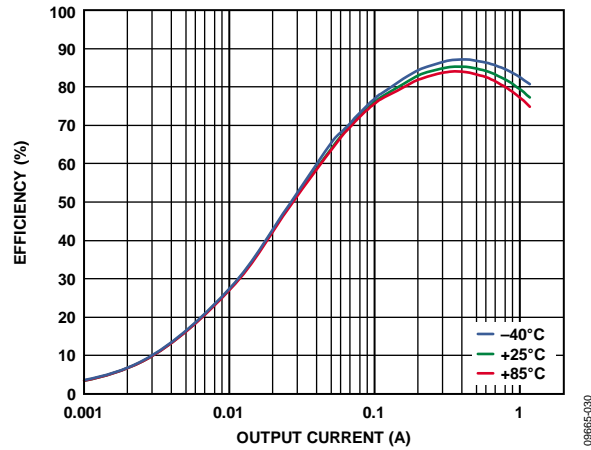

Figure 30. Buck Efficiency vs. Load Current, Across Temperature,  $V_{IN} = 5.0\text{ V}$ ,  $V_{OUT1} = 1.2\text{ V}$ , PWM Mode

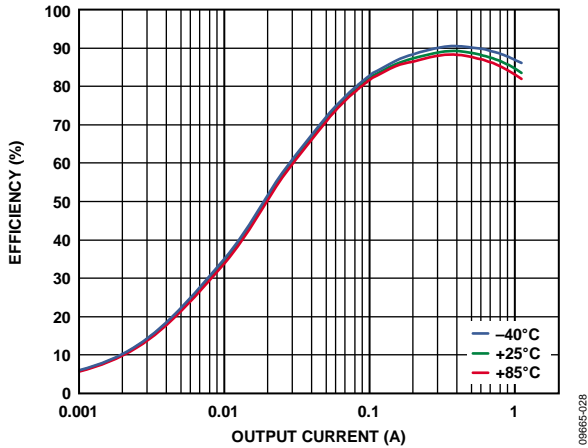

Figure 28. Buck Efficiency vs. Load Current, Across Temperature,  $V_{IN} = 5.0\text{ V}$ ,  $V_{OUT1} = 1.8\text{ V}$ , PWM Mode

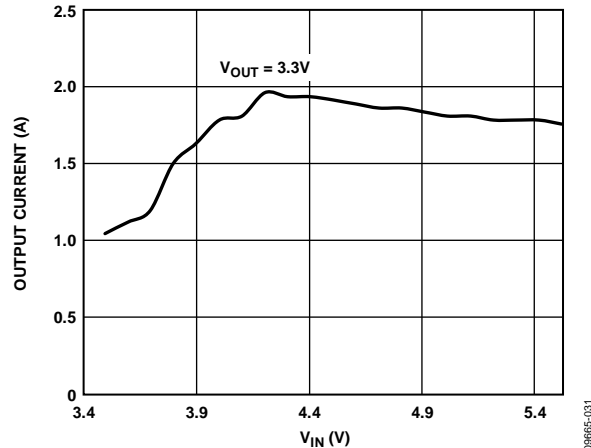

Figure 31. Buck DC Current Capability vs. Input Voltage

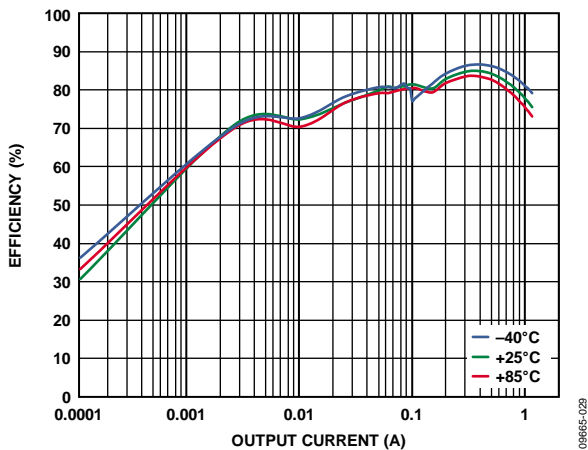

Figure 29. Buck Efficiency vs. Load Current, Across Temperature,  $V_{IN} = 5.0\text{ V}$ ,  $V_{OUT1} = 1.2\text{ V}$ , Auto Mode

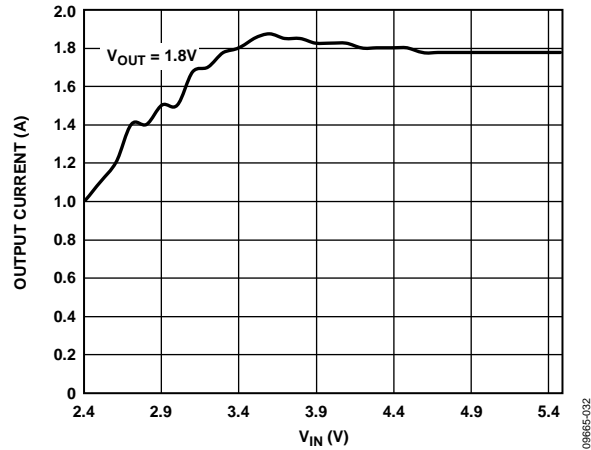

Figure 32. Buck DC Current Capability vs. Input Voltage

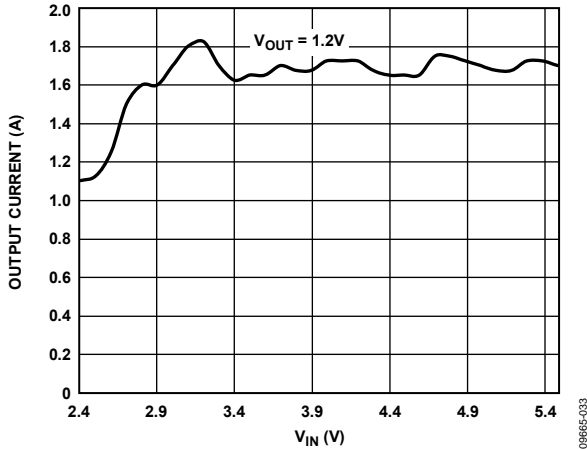

Figure 33. Buck DC Current Capability vs. Input Voltage

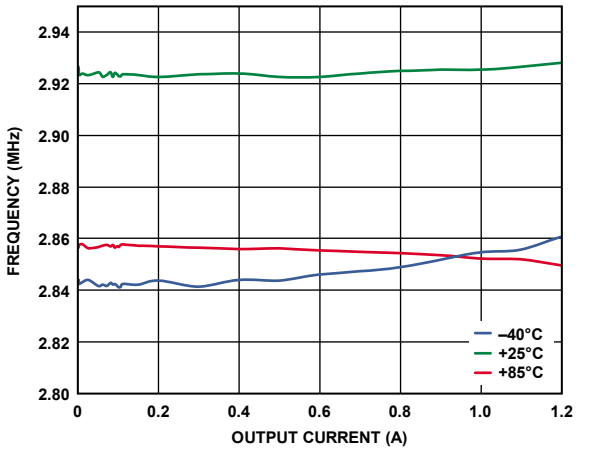

Figure 34. Buck Switching Frequency vs. Output Current, Across Temperature,  $V_{OUT1} = 1.8\text{ V}$ , PWM Mode

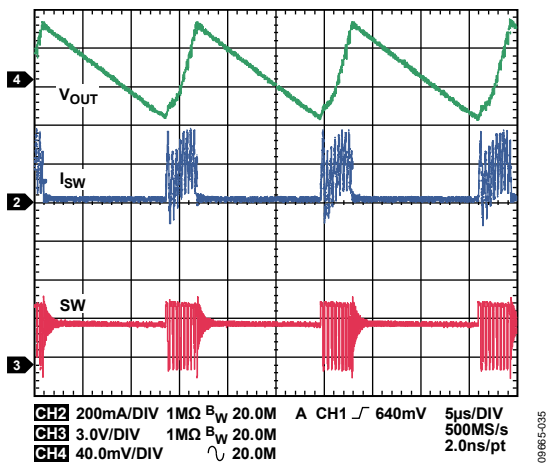

Figure 35. Typical Waveforms,  $V_{OUT1} = 3.3\text{ V}$ ,  $I_{OUT1} = 30\text{ mA}$ , Auto Mode

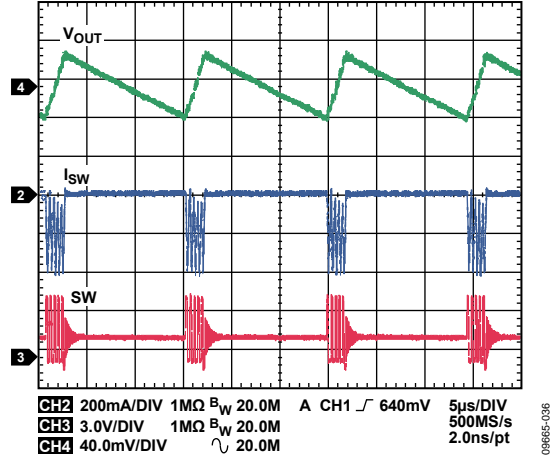

Figure 36. Typical Waveforms,  $V_{OUT1} = 1.8\text{ V}$ ,  $I_{OUT1} = 30\text{ mA}$ , Auto Mode

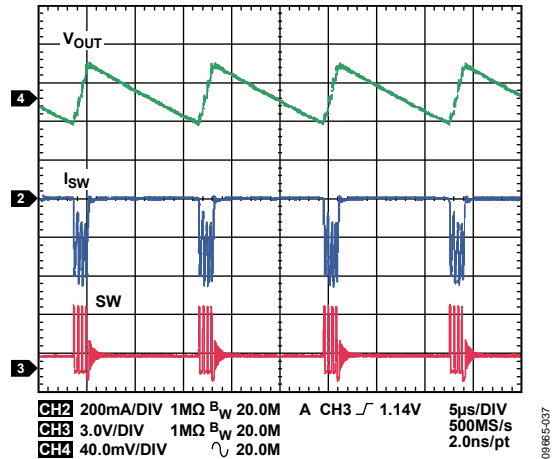

Figure 37. Typical Waveforms,  $V_{OUT1} = 1.2\text{ V}$ ,  $I_{OUT1} = 30\text{ mA}$ , Auto Mode

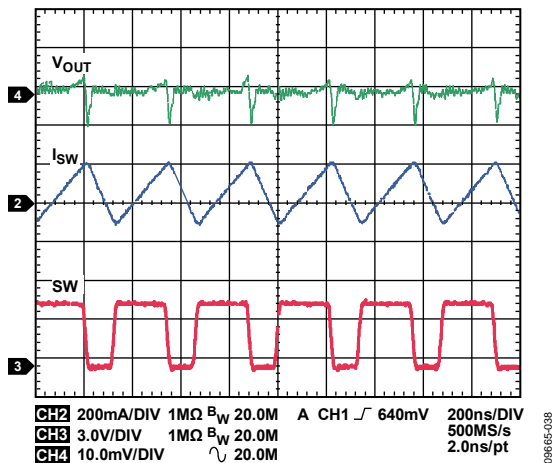

Figure 38. Typical Waveforms,  $V_{OUT1} = 3.3\text{ V}$ ,  $I_{OUT1} = 30\text{ mA}$ , PWM Mode

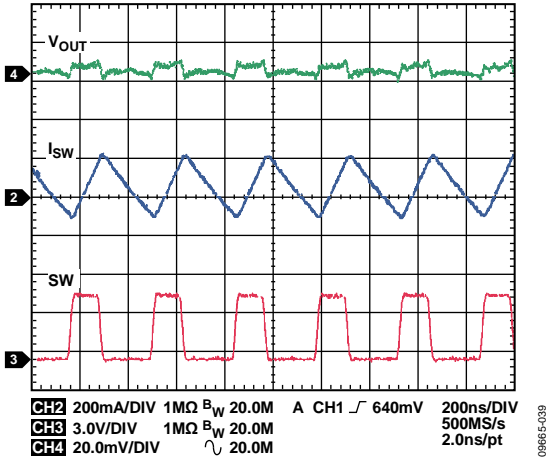

Figure 39. Typical Waveforms,  $V_{OUT1} = 1.8\text{ V}$ ,  $I_{OUT1} = 30\text{ mA}$ , PWM Mode

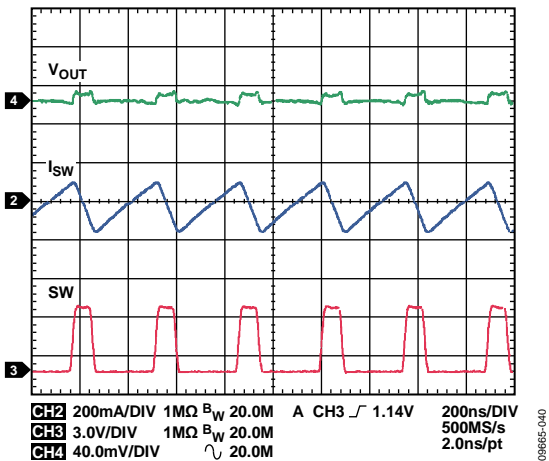

Figure 40. Typical Waveforms,  $V_{OUT1} = 1.2\text{ V}$ ,  $I_{OUT1} = 30\text{ mA}$ , PWM Mode

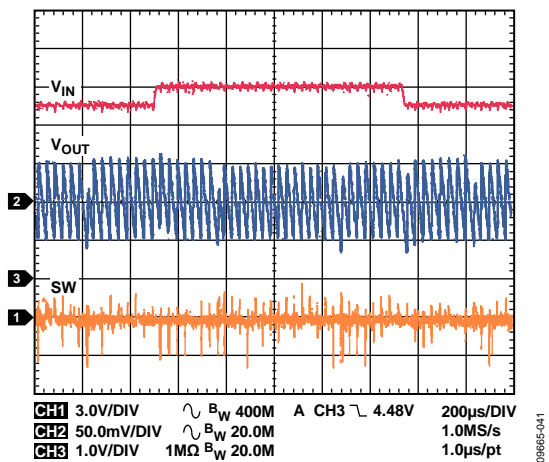

Figure 41. Buck Response to Line Transient, Input Voltage from 4.5 V to 5.0 V,  $V_{OUT1} = 3.3\text{ V}$ ,  $I_{OUT1} = 5\text{ mA}$ , Auto Mode

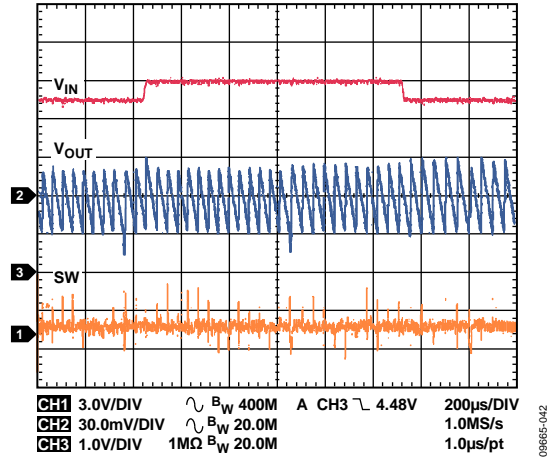

Figure 42. Buck Response to Line Transient, Input Voltage from 4.5 V to 5.0 V,  $V_{OUT1} = 1.8\text{ V}$ ,  $I_{OUT1} = 5\text{ mA}$ , Auto Mode

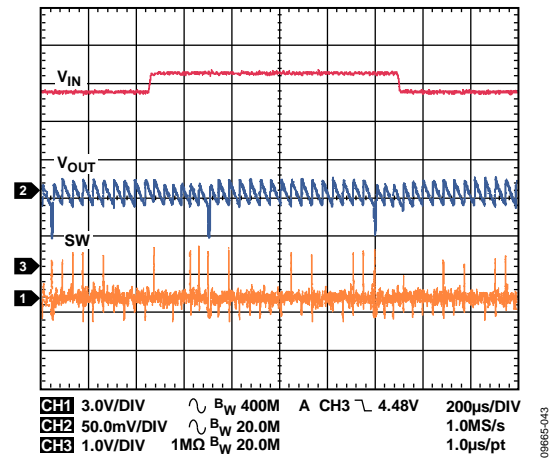

Figure 43. Buck Response to Line Transient, Input Voltage from 4.5 V to 5.0 V,  $V_{OUT1} = 1.2\text{ V}$ ,  $I_{OUT1} = 5\text{ mA}$ , Auto Mode

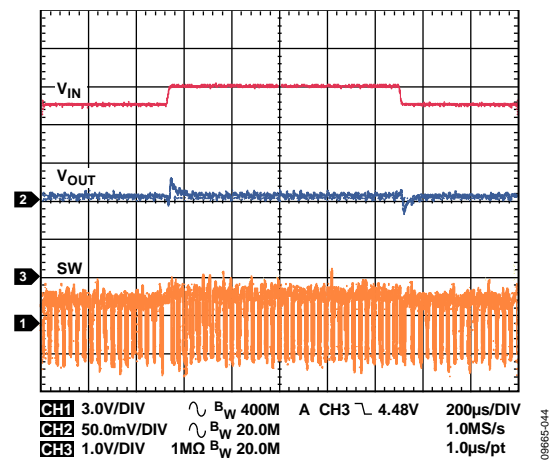

Figure 44. Buck Response to Line Transient, Input Voltage from 4.5 V to 5.0 V,  $V_{OUT1} = 3.3\text{ V}$ , PWM Mode

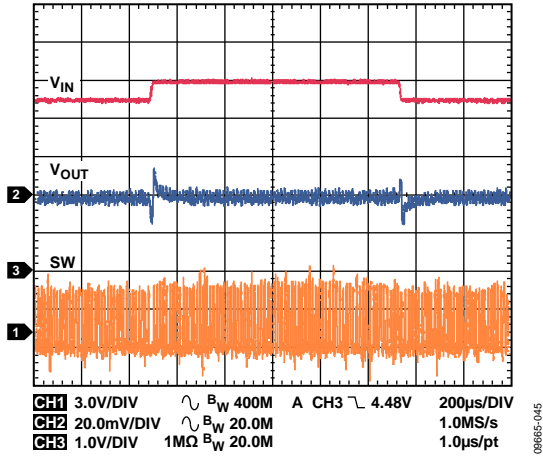

Figure 45. Buck Response to Line Transient, Input Voltage from 4.5 V to 5.0 V,  $V_{OUT1} = 1.8$  V, PWM Mode

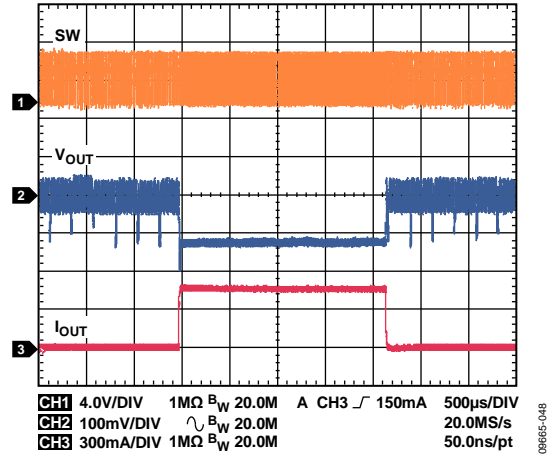

Figure 48. Buck Response to Load Transient,  $I_{OUT1} = 50$  mA to 500 mA,  $V_{OUT1} = 3.3$  V, Auto Mode

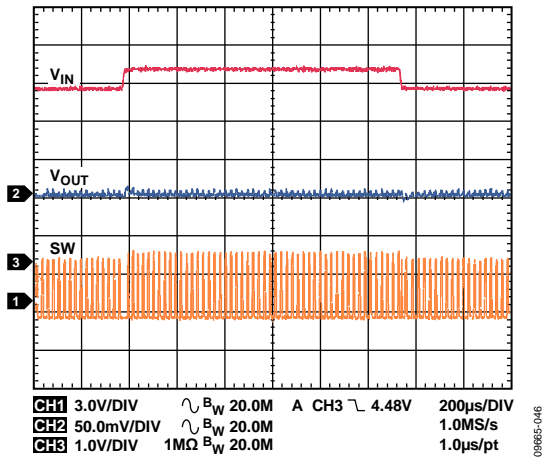

Figure 46. Buck Response to Line Transient, Input Voltage from 4.5 V to 5.0 V,  $V_{OUT1} = 1.2$  V, PWM Mode

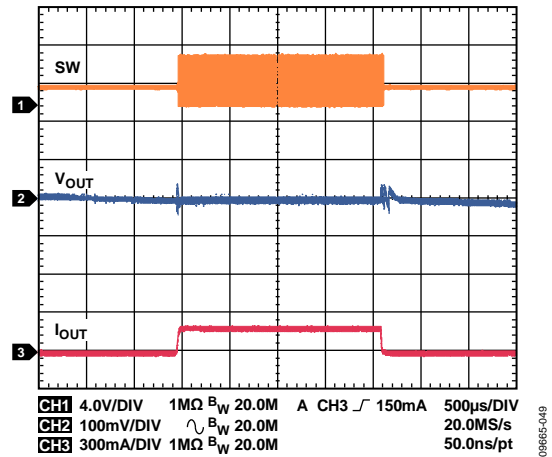

Figure 49. Buck Response to Load Transient,  $I_{OUT1} = 20$  mA to 200 mA,  $V_{OUT1} = 1.8$  V, Auto Mode

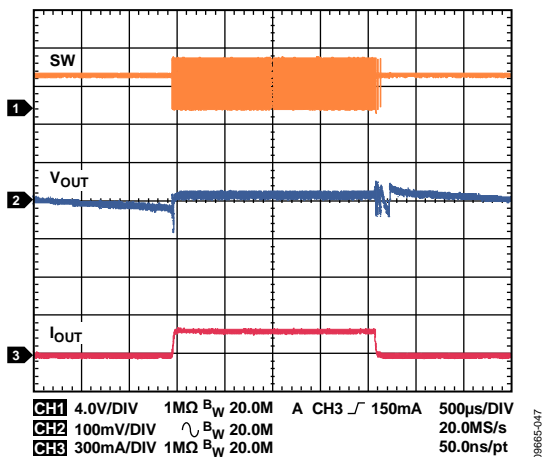

Figure 47. Buck Response to Load Transient,  $I_{OUT1} = 20$  mA to 200 mA,  $V_{OUT1} = 3.3$  V, Auto Mode

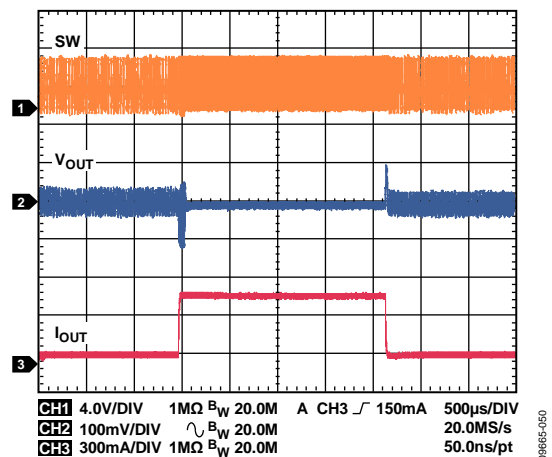

Figure 50. Buck Response to Load Transient,  $I_{OUT1} = 50$  mA to 500 mA,  $V_{OUT1} = 1.8$  V, Auto Mode



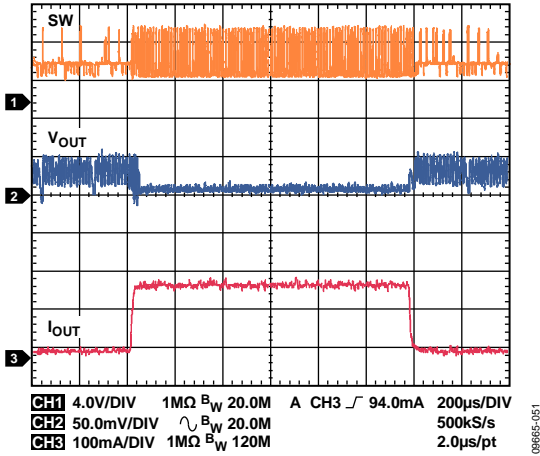

Figure 51. Buck Response to Load Transient,  $I_{OUT1} = 20 \text{ mA}$  to  $200 \text{ mA}$ ,  $V_{OUT1} = 1.2 \text{ V}$ , Auto Mode

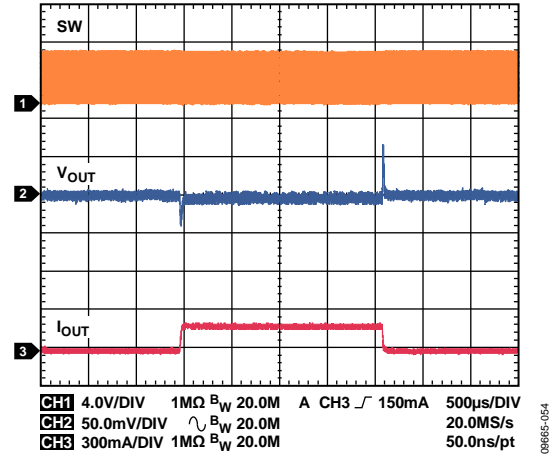

Figure 54. Buck Response to Load Transient,  $I_{OUT1} = 50 \text{ mA}$  to  $500 \text{ mA}$ ,  $V_{OUT1} = 3.3 \text{ V}$ , PWM Mode

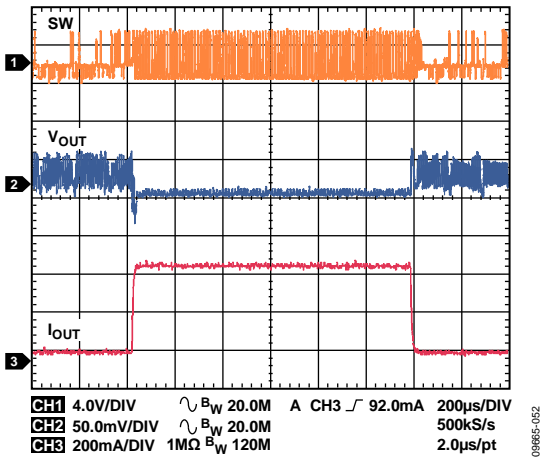

Figure 52. Buck Response to Load Transient,  $I_{OUT1} = 50 \text{ mA}$  to  $500 \text{ mA}$ ,  $V_{OUT1} = 1.2 \text{ V}$ , Auto Mode

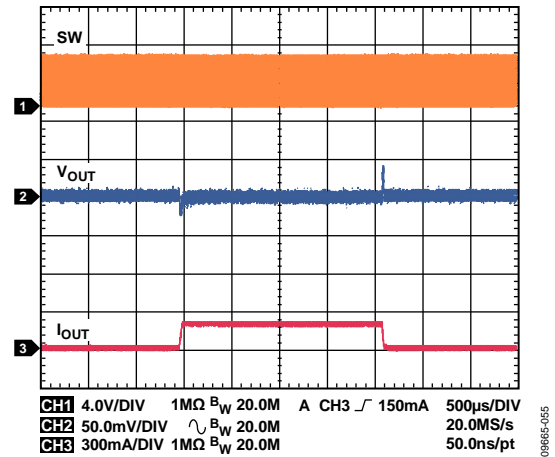

Figure 55. Buck Response to Load Transient,  $I_{OUT1} = 20 \text{ mA}$  to  $200 \text{ mA}$ ,  $V_{OUT1} = 1.8 \text{ V}$ , PWM Mode

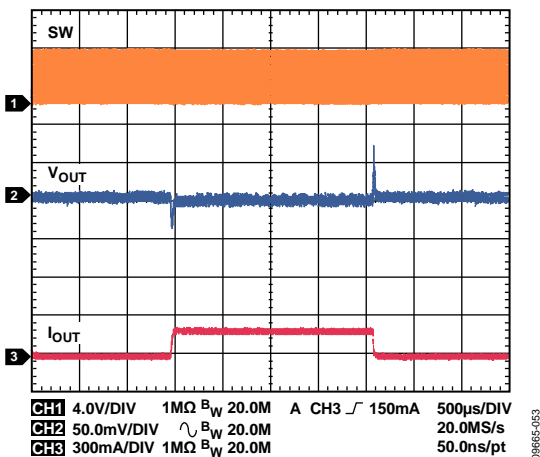

Figure 53. Buck Response to Load Transient,  $I_{OUT1} = 20 \text{ mA}$  to  $200 \text{ mA}$ ,  $V_{OUT1} = 3.3 \text{ V}$ , PWM Mode

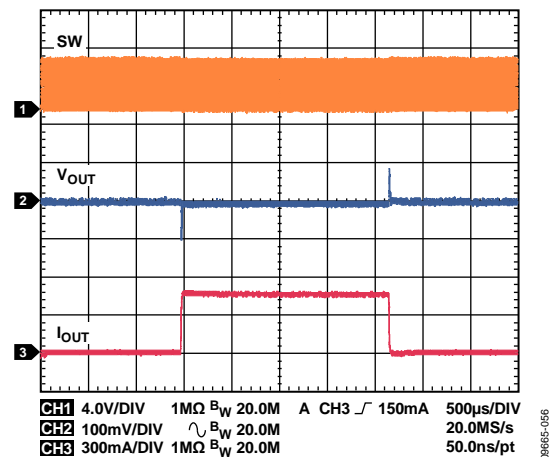

Figure 56. Buck Response to Load Transient,  $I_{OUT1} = 50 \text{ mA}$  to  $500 \text{ mA}$ ,  $V_{OUT1} = 1.8 \text{ V}$ , PWM Mode

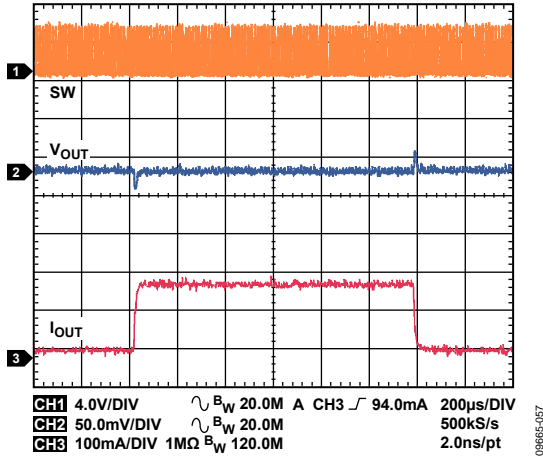

Figure 57. Buck Response to Load Transient,  $I_{OUT1} = 20\text{ mA to }200\text{ mA}$ ,  $V_{OUT1} = 1.2\text{ V}$ , PWM Mode

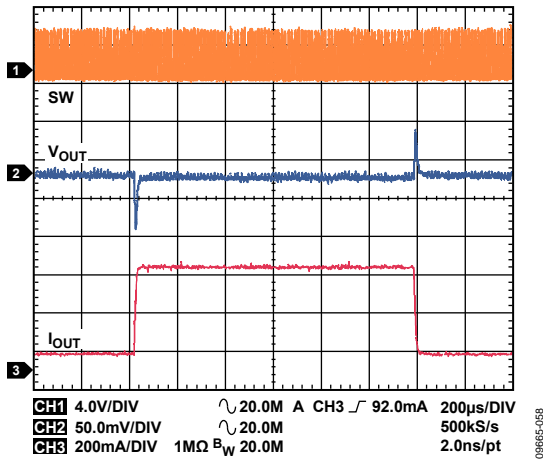

Figure 58. Buck Response to Load Transient,  $I_{OUT1} = 50\text{ mA to }500\text{ mA}$ ,  $V_{OUT1} = 1.2\text{ V}$ , PWM Mode

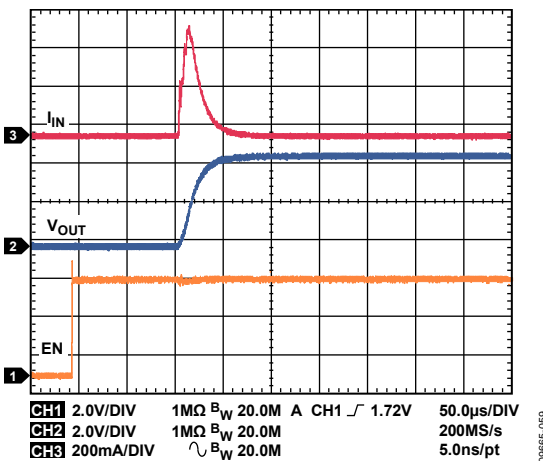

Figure 59. LDO1, LDO2 Startup,  $V_{OUT} = 4.7\text{ V}$ ,  $I_{OUT} = 5\text{ mA}$

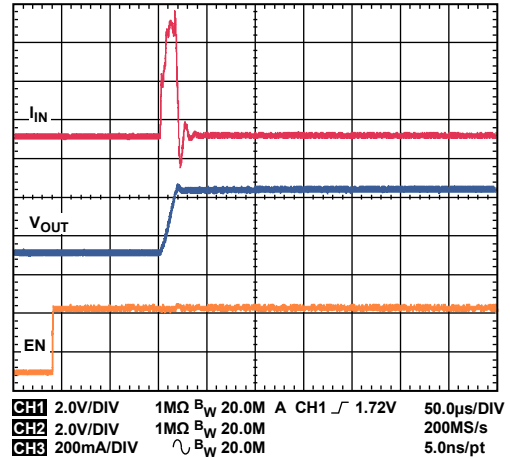

Figure 60. LDO1, LDO2 Startup,  $V_{OUT} = 3.3\text{ V}$ ,  $I_{OUT} = 5\text{ mA}$

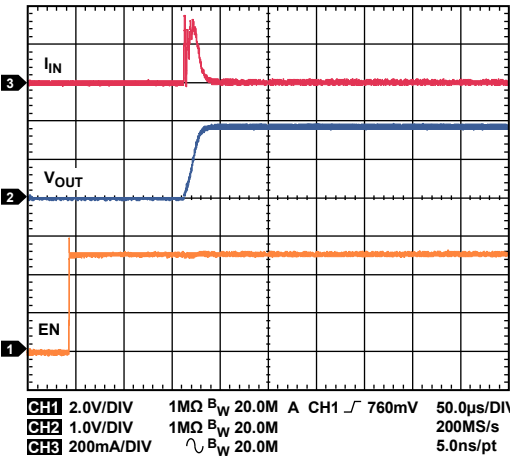

Figure 61. LDO1, LDO2 Startup,  $V_{OUT} = 1.8\text{ V}$ ,  $I_{OUT} = 5\text{ mA}$

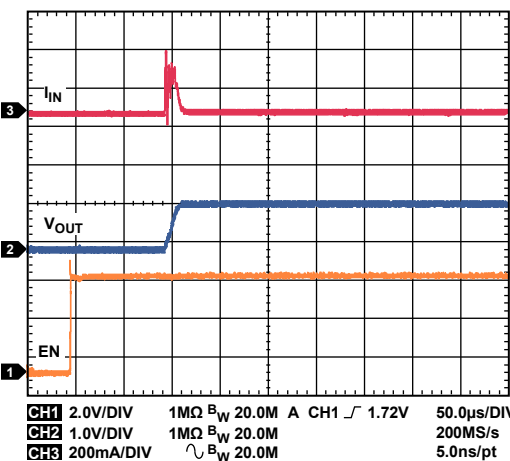

Figure 62. LDO1, LDO2 Startup,  $V_{OUT} = 1.2\text{ V}$ ,  $I_{OUT} = 5\text{ mA}$

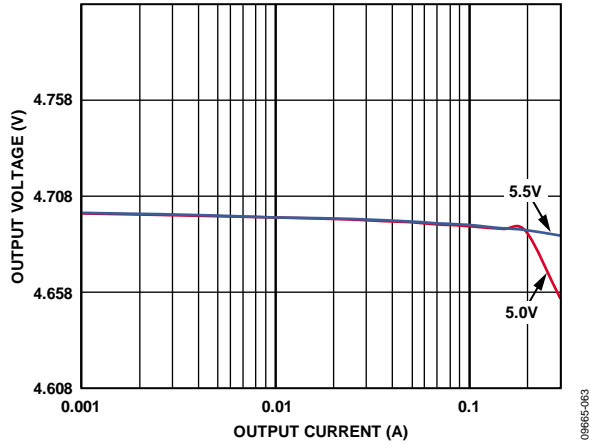

Figure 63. LDO1, LDO2 Load Regulation Across Input Voltage,  $V_{OUT} = 4.7\text{ V}$

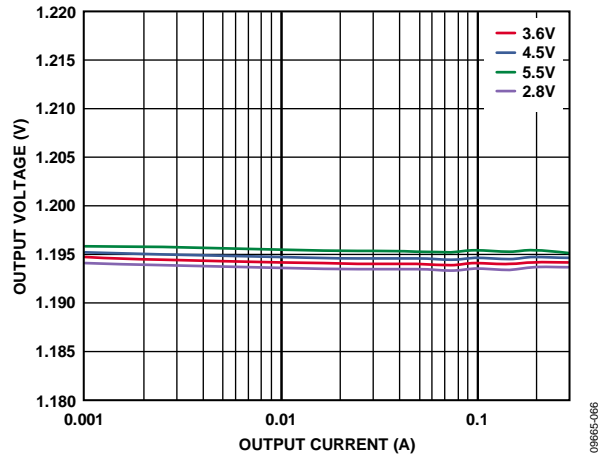

Figure 66. LDO1, LDO2 Load Regulation Across Input Voltage,  $V_{OUT} = 1.2\text{ V}$

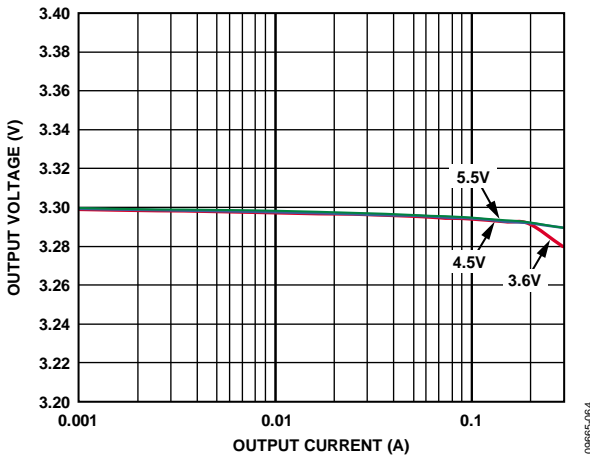

Figure 64. LDO1, LDO2 Load Regulation Across Input Voltage,  $V_{OUT} = 3.3\text{ V}$

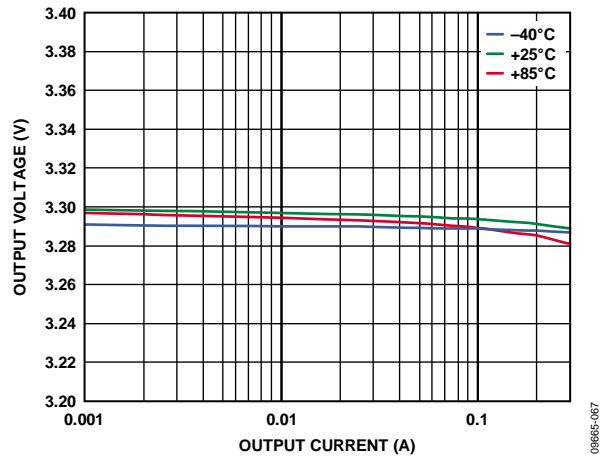

Figure 67. LDO1, LDO2 Load Regulation Across Temperature,  $V_{IN} = 3.6\text{ V}$ ,  $V_{OUT} = 3.3\text{ V}$

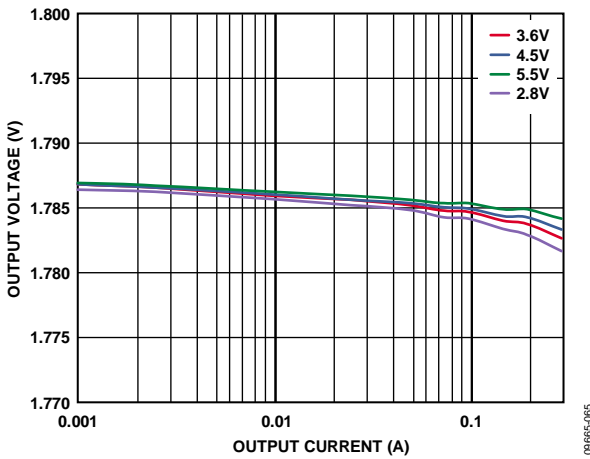

Figure 65. LDO1, LDO2 Load Regulation Across Input Voltage,  $V_{OUT} = 1.8\text{ V}$

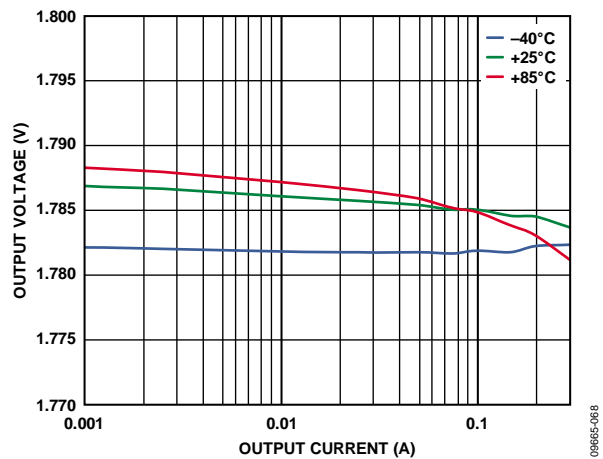

Figure 68. LDO1, LDO2 Load Regulation Across Temperature,  $V_{IN} = 3.6\text{ V}$ ,  $V_{OUT} = 1.8\text{ V}$

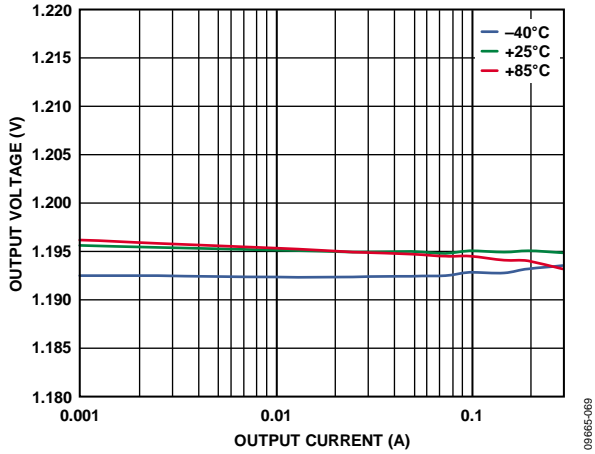

Figure 69. LDO1, LDO2 Load Regulation Across Temperature,  $V_{IN} = 3.6\text{ V}$ ,  $V_{OUT} = 1.2\text{ V}$

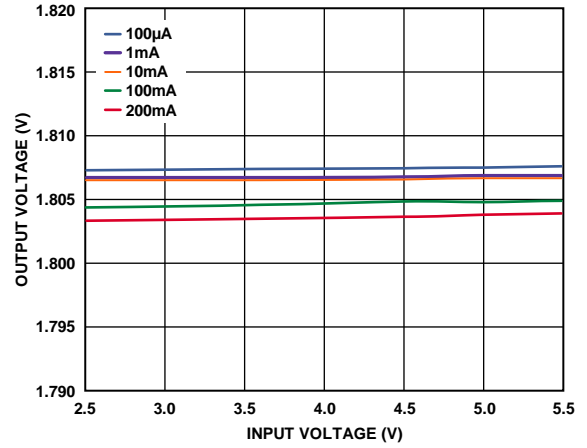

Figure 72. LDO1, LDO2 Line Regulation Across Input Voltage,  $V_{OUT} = 1.8\text{ V}$

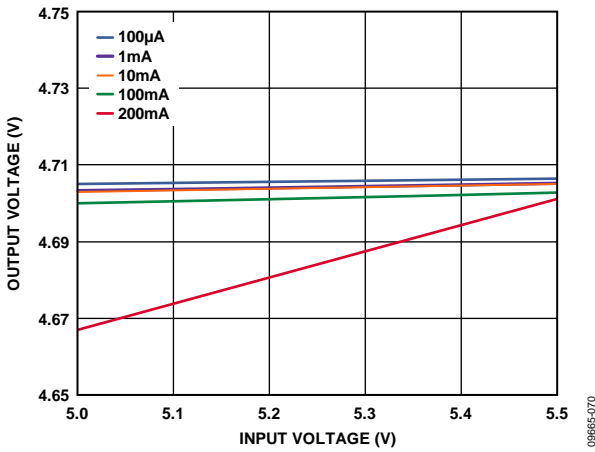

Figure 70. LDO1, LDO2 Line Regulation Across Input Voltage,  $V_{OUT} = 4.7\text{ V}$

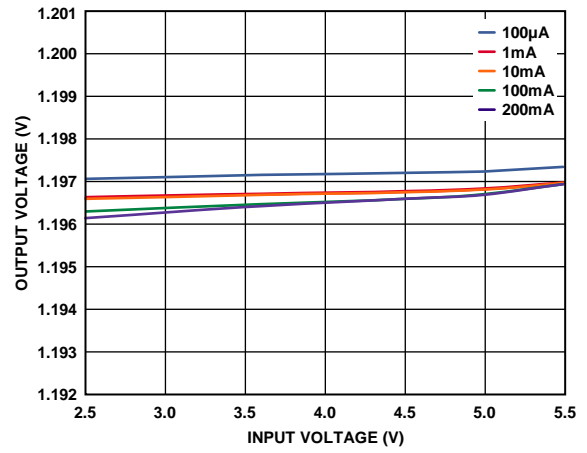

Figure 73. LDO1, LDO2 Line Regulation Across Input Voltage,  $V_{OUT} = 1.2\text{ V}$

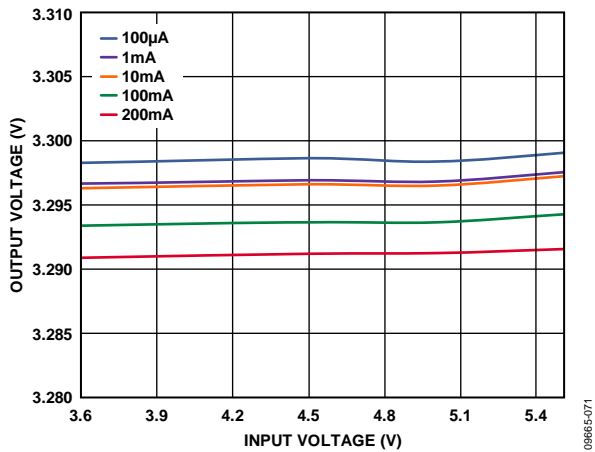

Figure 71. LDO1, LDO2 Line Regulation Across Input Voltage,  $V_{OUT} = 3.3\text{ V}$

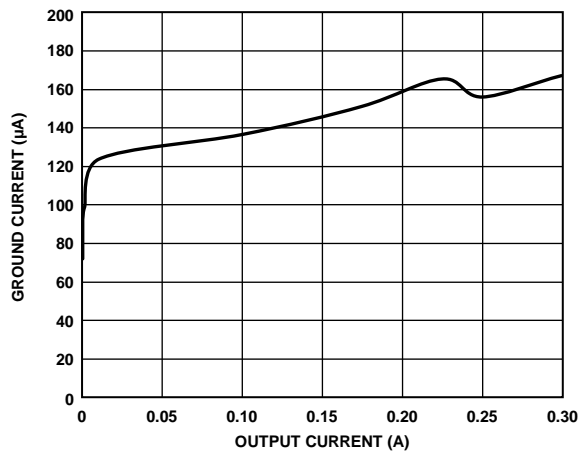

Figure 74. LDO1, LDO2 Ground Current vs. Output Current,  $V_{OUT} = 3.3\text{ V}$

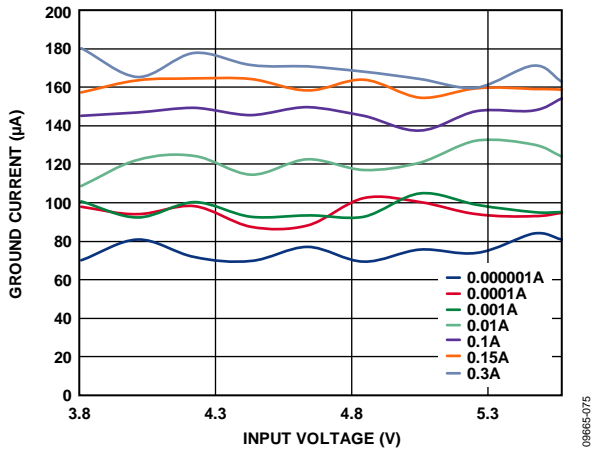

Figure 75. LDO1, LDO2 Ground Current vs. Input Voltage, Across Output Load (A),  $V_{OUT} = 3.3\text{ V}$

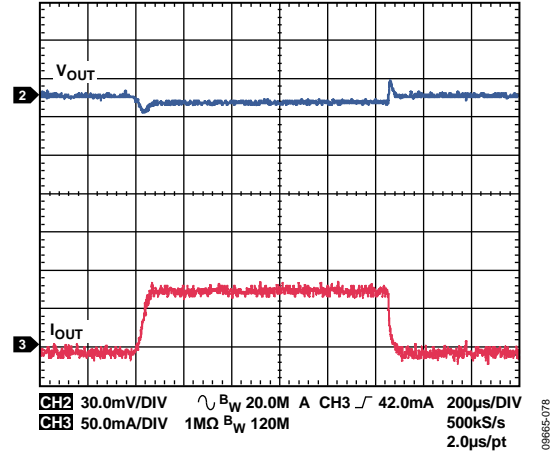

Figure 78. LDO1, LDO2 Response to Load Transient,  $I_{OUT}$  from 1 mA to 80 mA,  $V_{OUT} = 3.3\text{ V}$

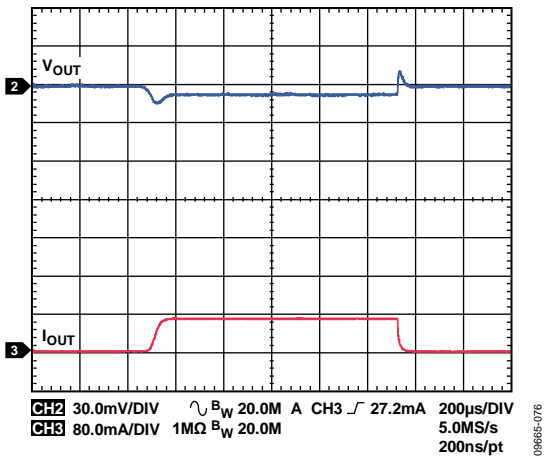

Figure 76. LDO1, LDO2 Response to Load Transient,  $I_{OUT}$  from 1 mA to 80 mA,  $V_{OUT} = 4.7\text{ V}$

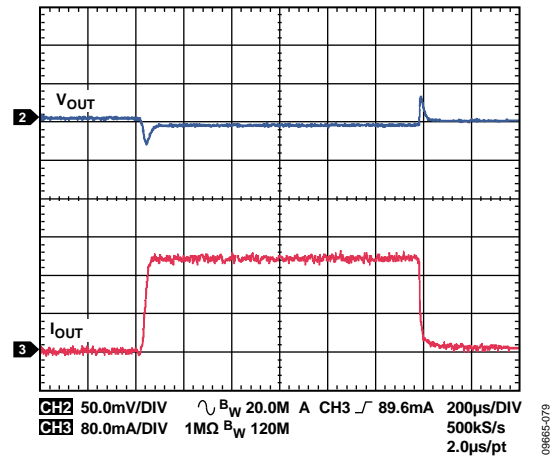

Figure 79. LDO1, LDO2 Response to Load Transient,  $I_{OUT}$  from 10 mA to 200 mA,  $V_{OUT} = 3.3\text{ V}$

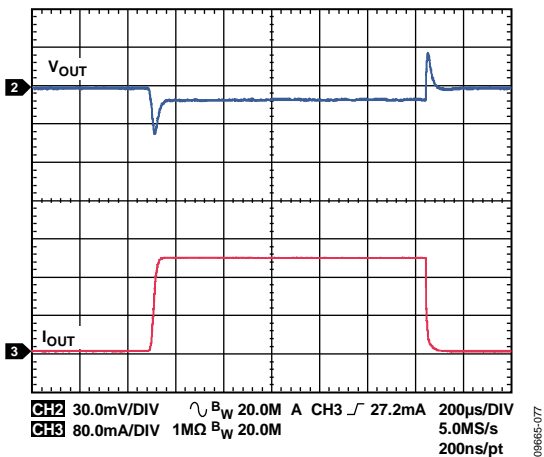

Figure 77. LDO1, LDO2 Response to Load Transient,  $I_{OUT}$  from 10 mA to 200 mA,  $V_{OUT} = 4.7\text{ V}$

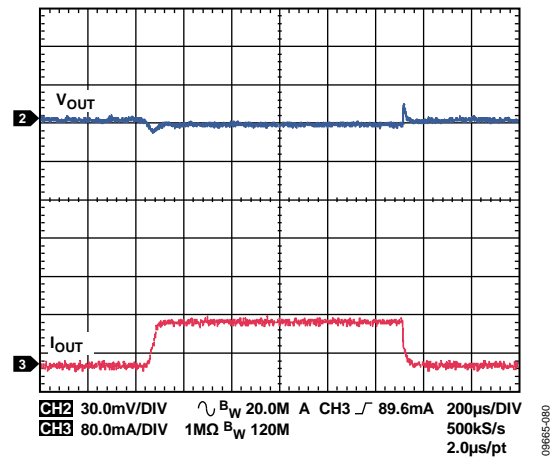

Figure 80. LDO1, LDO2 Response to Load Transient,  $I_{OUT}$  from 1 mA to 80 mA,  $V_{OUT} = 1.8\text{ V}$

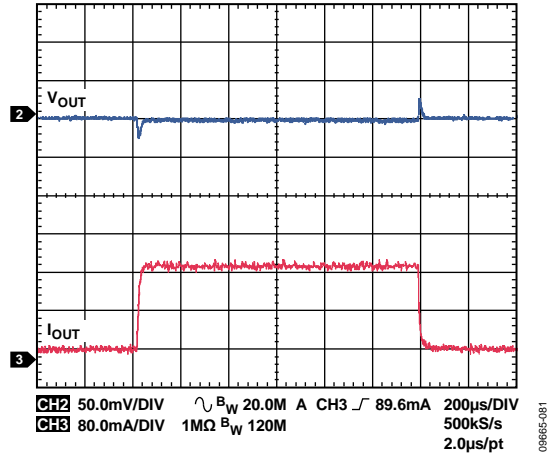

Figure 81. LDO1, LDO2 Response to Load Transient,  $I_{OUT}$  from 10 mA to 20 mA,  $V_{OUT} = 1.8$  V

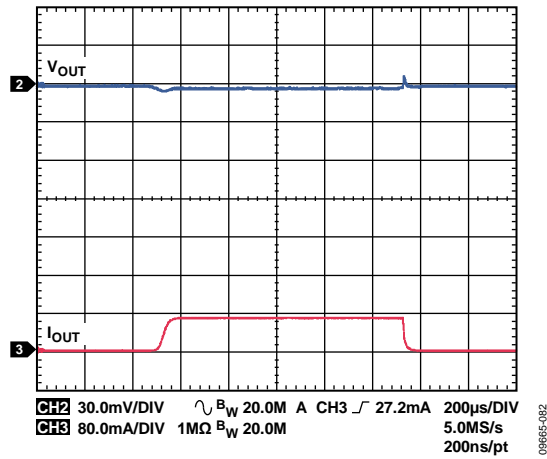

Figure 82. LDO1, LDO2 Response to Load Transient,  $I_{OUT}$  from 1 mA to 80 mA,  $V_{OUT} = 1.2$  V

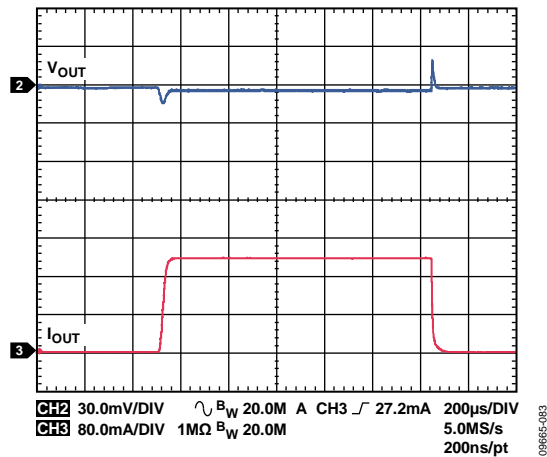

Figure 83. LDO1, LDO2 Response to Load Transient,  $I_{OUT}$  from 10 mA to 200 mA,  $V_{OUT} = 1.2$  V

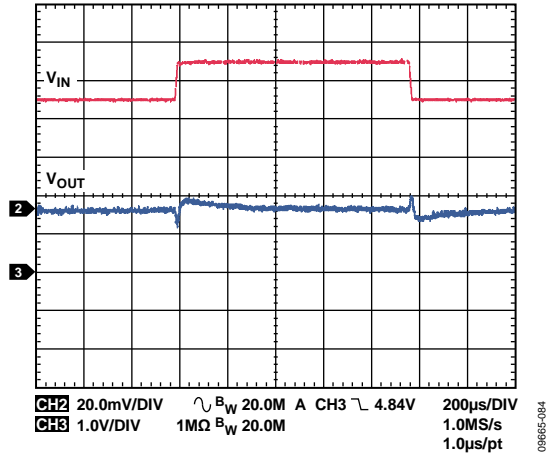

Figure 84. LDO1, LDO2 Response to Line Transient, Input Voltage from 4.5 V to 5.5 V,  $V_{OUT} = 3.3$  V

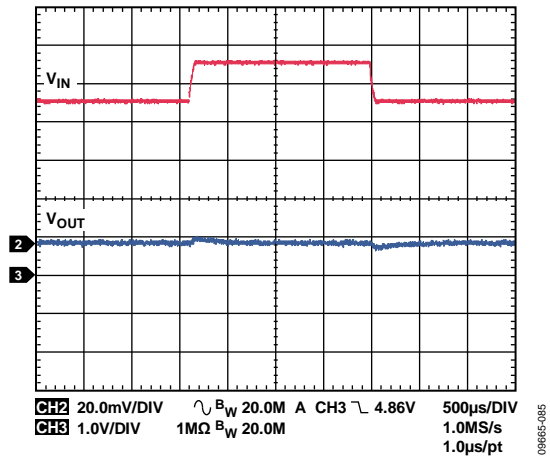

Figure 85. LDO1, LDO2 Response to Line Transient, Input Voltage from 4.5 V to 5.5 V,  $V_{OUT} = 1.8$  V

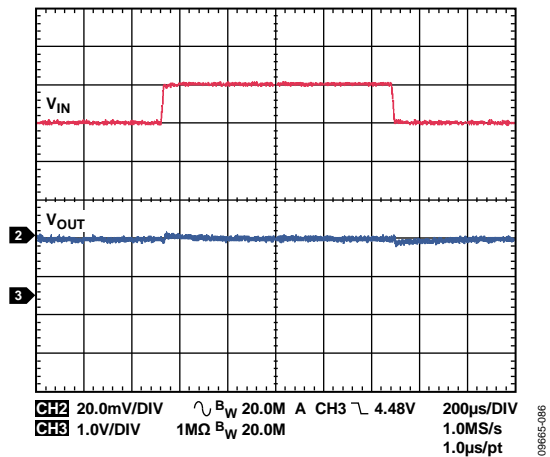

Figure 86. LDO1, LDO2 Response to Line Transient, Input Voltage from 4.5 V to 5.5 V,  $V_{OUT} = 1.2$  V

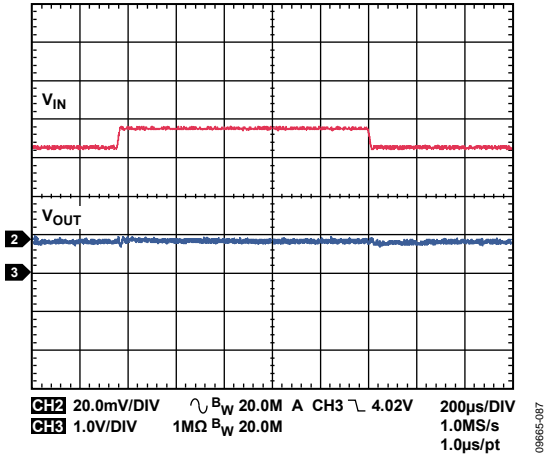

Figure 87. LDO1, LDO2 Response to Line Transient, Input Voltage from 3.3 V to 3.8 V,  $V_{OUT} = 1.8 V$

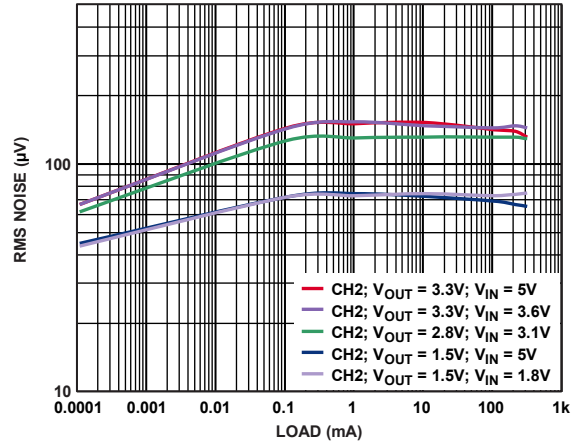

Figure 90. LDO1 Output Noise vs. Load Current, Across Input and Output Voltage

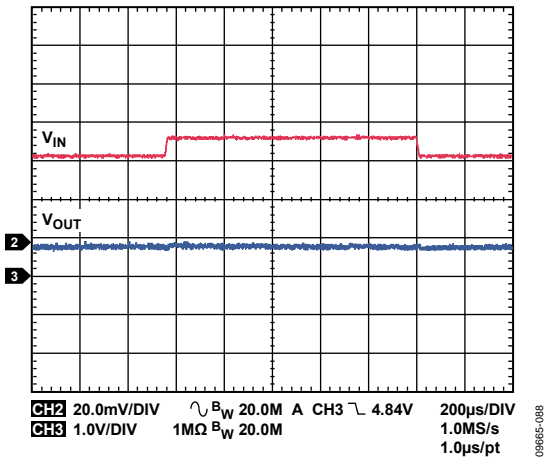

Figure 88. LDO1, LDO2 Response to Line Transient, Input Voltage from 3.3 V to 3.8 V,  $V_{OUT} = 1.2 V$

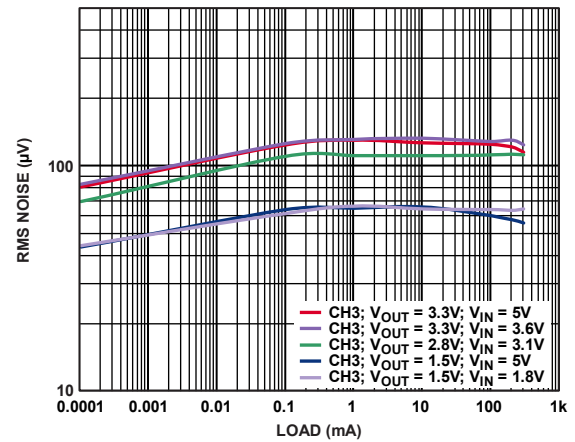

Figure 91. LDO2 Output Noise vs. Load Current, Across Input and Output Voltage

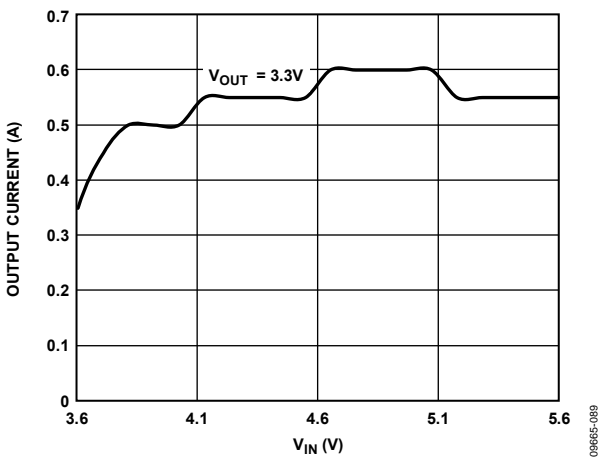

Figure 89. LDO1, LDO2 Output Current Capability vs. Input Voltage

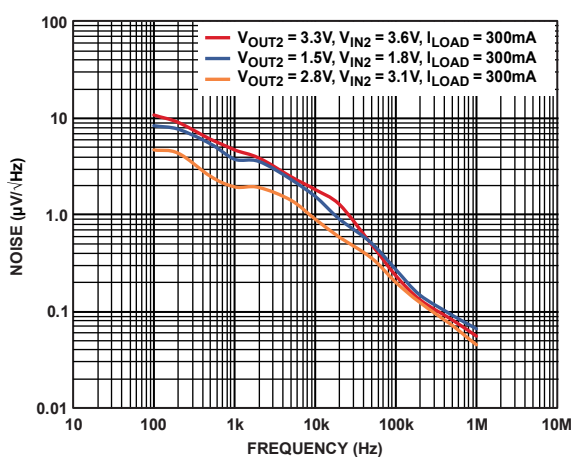

Figure 92. LDO1 Noise Spectrum Cross Output Voltage,  $V_{IN} = V_{OUT} + 0.3 V$

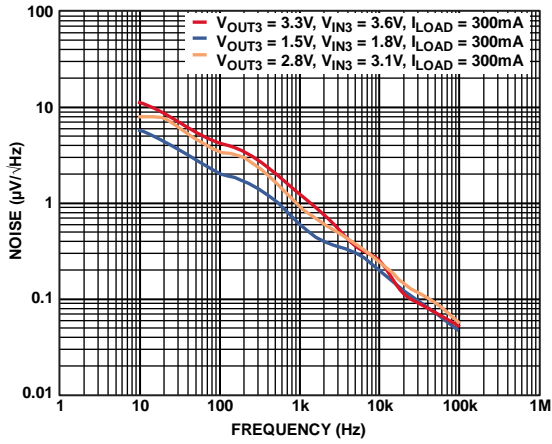

Figure 93. LDO2 Noise Spectrum Across Output Voltage,  $V_{\text{IN}} = V_{\text{OUT}} + 0.3\text{V}$

09665-115

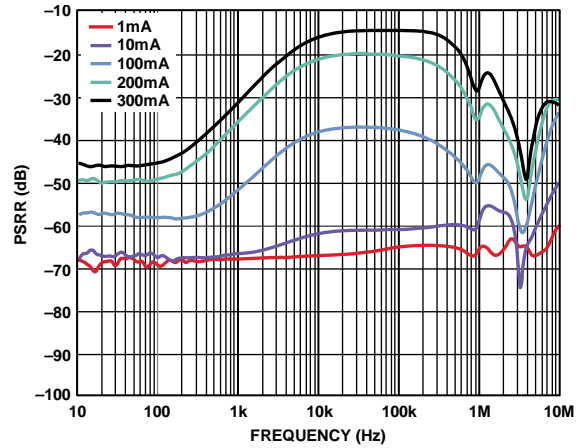

Figure 96. LDO2 PSRR Across Output Load,  $V_{\text{IN}3} = 3.1\text{V}, V_{\text{OUT}3} = 2.8\text{V}$

09665-110

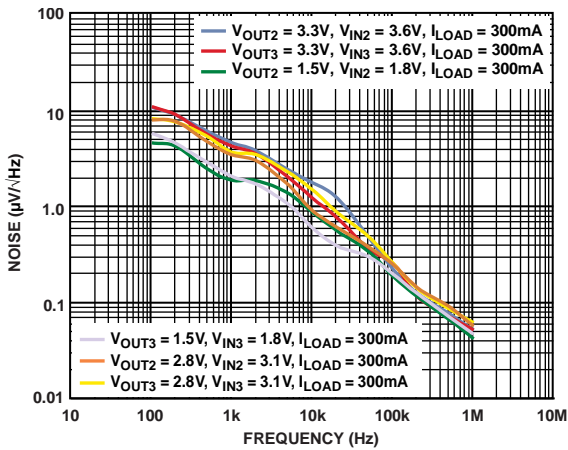

Figure 94. LDO1 vs. LDO2 Noise Spectrum

09665-108

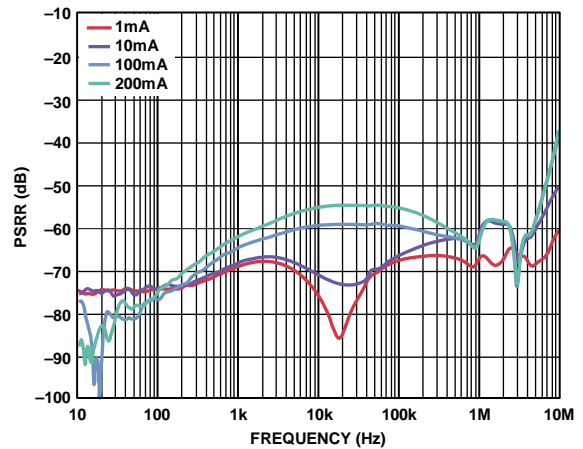

Figure 97. LDO2 PSRR Across Output Load,  $V_{\text{IN}3} = 5.0\text{V}, V_{\text{OUT}3} = 3.3\text{V}$

09665-111

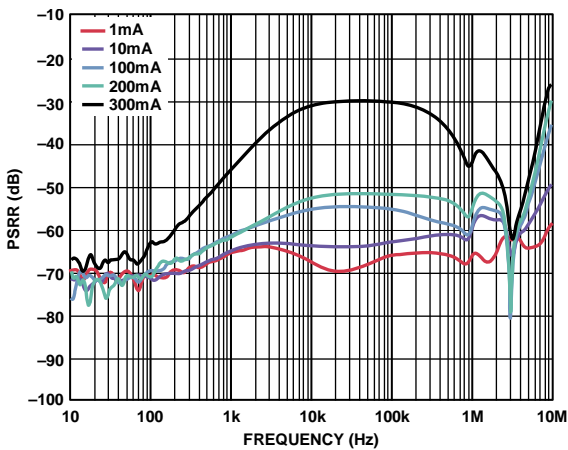

Figure 95. LDO2 PSRR Across Output Load,  $V_{\text{IN}3} = 3.3\text{V}, V_{\text{OUT}3} = 2.8\text{V}$

09665-109

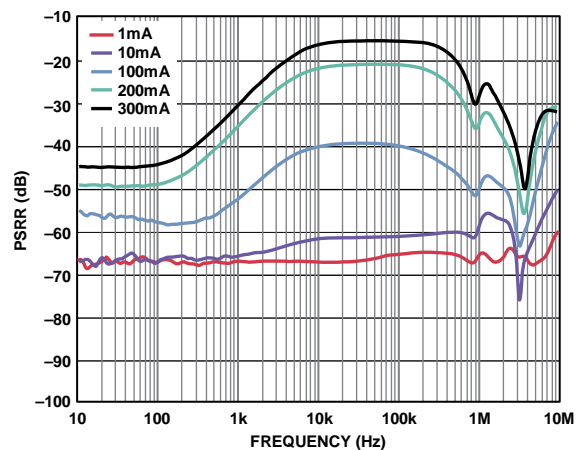

Figure 98. LDO2 PSRR Across Output Load,  $V_{\text{IN}3} = 3.6\text{V}, V_{\text{OUT}3} = 3.3\text{V}$

09665-112



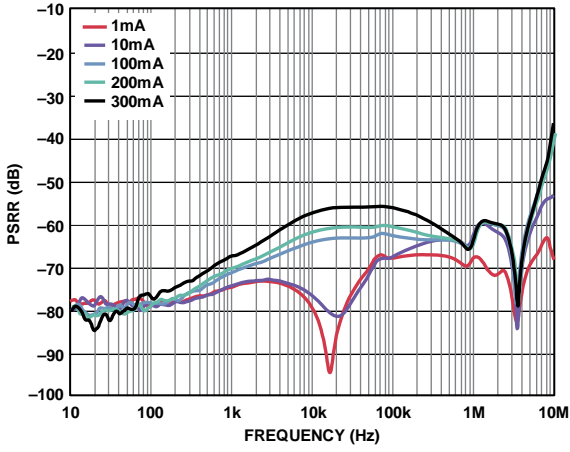

Figure 99. LDO1 PSRR Across Output Load,  
 $V_{IN2} = 5.0\text{ V}$ ,  $V_{OUT2} = 1.5\text{ V}$

09665-113

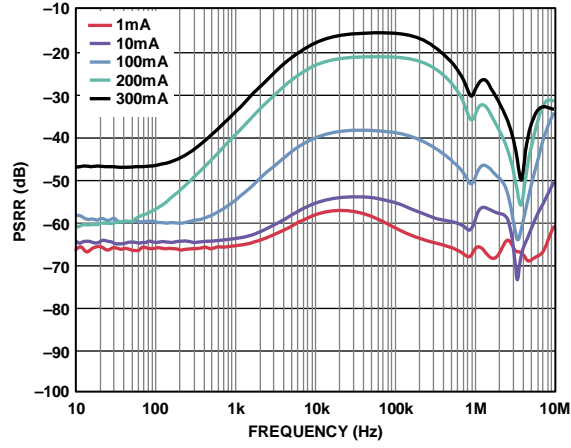

Figure 100. LDO1 PSRR Across Output Load,  
 $V_{IN2} = 1.8\text{ V}$ ,  $V_{OUT2} = 1.5\text{ V}$

09665-114

# THEORY OF OPERATION

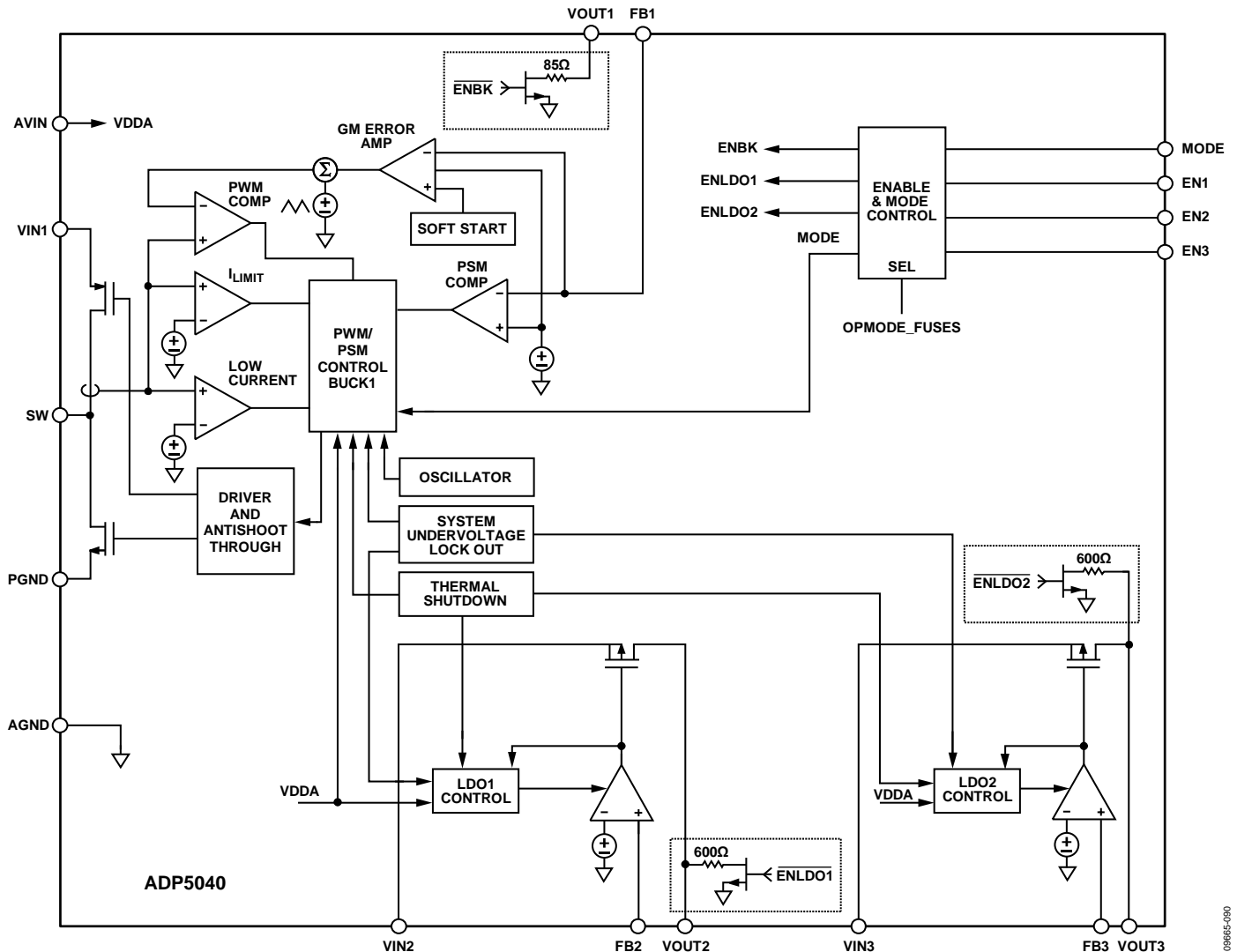

Figure 101. Functional Block Diagram

## POWER MANAGEMENT UNIT

The **ADP5040** is a micro power management unit (micro PMU) combining one step-down (buck) dc-to-dc regulator and two low dropout linear regulators (LDOs). The high switching frequency and tiny 20-pin LFCSP package allow for a small power management solution.

The regulators are activated by a logic level high applied to the respective EN pin. The EN1 pin controls the buck regulator, the EN2 pin controls LDO1, and the EN3 pin controls LDO2. The MODE pin controls the buck switching operation.

The regulator output voltages are set through external resistor dividers.

When a regulator is turned on, the output voltage ramp is controlled through a soft start circuit to avoid a large inrush current due to the discharged output capacitors.

The buck regulator can operate in forced PWM mode if the MODE pin is at a logic high level. In forced PWM mode, the switching frequency of the buck is always constant and does not change with the load current. If the MODE pin is at a logic low level, the switching regulator operates in auto PWM/PSM mode. In this mode, the regulator operates at fixed PWM frequency when the load current is above the power saving current threshold. When the load current falls below the power save current threshold, the regulator enters power saving mode, where the switching occurs in bursts. The burst repetition rate is a function of the current load and the output capacitor value. This operating mode reduces the switching and quiescent current losses.

### Thermal Protection

In the event that the junction temperature rises above 150°C, the thermal shutdown circuit turns off the buck and the LDOs. Extreme junction temperatures can be the result of high current operation, poor circuit board design, or high ambient temperature. A 20°C hysteresis is included in the thermal shutdown circuit so that when thermal shutdown occurs, the buck and the LDOs do not return to normal operation until the on-chip temperature drops below 130°C. When coming out of thermal shutdown, all regulators start with soft start control.

### Undervoltage Lockout

To protect against battery discharge, undervoltage lockout (UVLO) circuitry is integrated in the ADP5040. If the input voltage on AVIN drops below a typical 2.15 V UVLO threshold, all channels shut down. In the buck channel, both the power switch and the synchronous rectifier turn off. When the voltage on AVIN rises above the UVLO threshold, the part is enabled once more.

Alternatively, the user can select device models with a UVLO set at a higher level, suitable for 5 V applications. For these models, the device reaches the turn-off threshold when the input supply drops to 3.65 V typical.

### Enable/Shutdown

The ADP5040 has individual control pins for each regulator. A logic level high applied to the ENx pin activates a regulator, whereas a logic level low turns off a regulator.

### Active Pull-Down

The ADP5040 can be purchased with the active pull-down option enabled. The pull-down resistors are connected between each regulator output and AGND. The pull-downs are enabled, when the regulators are turned off. The typical value of the pull-down resistor is 600 Ω for the LDOs and 85 Ω for the buck.

## BUCK SECTION

The buck uses a fixed frequency and high speed current mode architecture. The buck operates with an input voltage of 2.3 V to 5.5 V.

The buck output voltage is set through external resistor dividers, as shown in Figure 102. VOUT1 must be connected to the output capacitor. VFB1 is internally set to 0.5 V. The output voltage can be set from 0.8 V to 3.8 V.

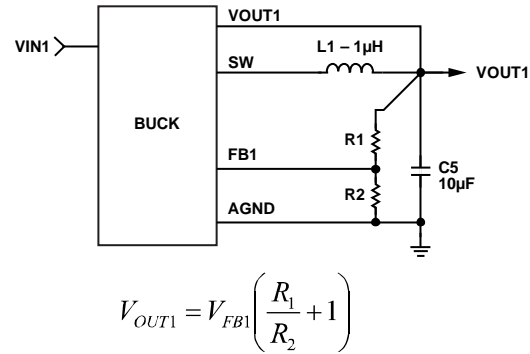

Figure 102. Buck External Output Voltage Setting

09865-081

### Control Scheme

The buck operates with a fixed frequency, current mode PWM control architecture at medium to high loads for high efficiency, but operation shifts to a power save mode (PSM) control scheme at light loads to lower the regulation power losses. When operating in fixed frequency PWM mode, the duty cycle of the integrated switches is adjusted and regulates the output voltage. When operating in PSM at light loads, the output voltage is controlled in a hysteretic manner, with higher output voltage ripple. During part of this time, the converter is able to stop switching and enters an idle mode, which improves conversion efficiency.

### PWM Mode

In PWM mode, the buck operates at a fixed frequency of 3 MHz, set by an internal oscillator. At the start of each oscillator cycle, the PFET switch is turned on, sending a positive voltage across the inductor. Current in the inductor increases until the current sense signal crosses the peak inductor current threshold that turns off the PFET switch and turns on the NFET synchronous rectifier. This sends a negative voltage across the inductor, causing the inductor current to decrease. The synchronous rectifier stays on for the rest of the cycle. The buck regulates the output voltage by adjusting the peak inductor current threshold.

### Power Save Mode (PSM)

The buck smoothly transitions to PSM operation when the load current decreases below the PSM current threshold. When the buck enters power save mode, an offset is introduced in the PWM regulation level, which makes the output voltage rise. When the output voltage reaches a level that is approximately 1.5% above the PWM regulation level, PWM operation is turned off. At this point, both power switches are off, and the buck enters an idle mode. The output capacitor discharges until the output voltage falls to the PWM regulation voltage, at which point the device drives the inductor to make the output voltage rise again to the upper threshold. This process is repeated while the load current is below the PSM current threshold.

The ADP5040 has a dedicated MODE pin controlling the PSM and PWM operation. A high logic level applied to the MODE pin forces the buck to operate in PWM mode. A logic level low sets the buck to operate in auto PSM/PWM.

### PSM Current Threshold

The PSM current threshold is set to 100 mA. The buck employs a scheme that enables this current to remain accurately controlled, independent of input and output voltage levels. This scheme also ensures that there is very little hysteresis between the PSM current threshold for entry to, and exit from, the PSM mode. The PSM current threshold is optimized for excellent efficiency over all load currents.

### Short-Circuit Protection

The buck includes frequency foldback to prevent current runaway on a hard short at the output. When the voltage at the feedback pin falls below half the internal reference voltage, indicating the possibility of a hard short at the output, the switching frequency is reduced to half the internal oscillator frequency. The reduction in the switching frequency allows more time for the inductor to discharge, preventing a runaway of output current.

### Soft Start

The buck has an internal soft start function that ramps the output voltage in a controlled manner upon startup, thereby limiting the inrush current. This prevents possible input voltage drops when a battery or a high impedance power source is connected to the input of the converter.

### Current Limit

The buck has protection circuitry to limit the amount of positive current flowing through the PFET switch and the amount of negative current flowing through the synchronous rectifier. The positive current limit on the power switch limits the amount of current that can flow from the input to the output. The negative current limit prevents the inductor current from reversing direction and flowing out of the load.

### 100% Duty Operation

With a dropping input voltage or with an increase in load current, the buck may reach a limit where, even with the PFET

switch on 100% of the time, the output voltage drops below the desired output voltage. At this limit, the buck transitions to a mode where the PFET switch stays on 100% of the time. When the input conditions change again and the required duty cycle falls, the buck immediately restarts PWM regulation without allowing overshoot on the output voltage.

## LDO SECTION

The ADP5040 contains two LDOs with low quiescent current that provide output currents up to 300 mA. The low 10  $\mu$ A typical quiescent current at no load makes the LDO ideal for battery-operated portable equipment.

The LDOs operate with an input voltage range of 1.7 V to 5.5 V. The wide operating range makes these LDOs suitable for cascade configurations where the LDO supply voltage is provided from the buck regulator.

Each LDO output voltage is set through external resistor dividers as shown in Figure 103.  $V_{FB2}$  and  $V_{FB3}$  are internally set to 0.5 V. The output voltage can be set from 0.8 V to 5.2 V.

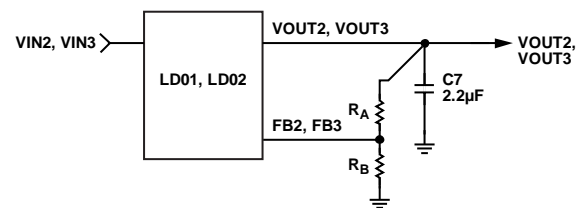

$$V_{OUT2, OUT3} = V_{FB2, FB3} \left( \frac{R_a}{R_b} + 1 \right)$$

Figure 103. LDOs External Output Voltage Setting

The LDOs also provide high power supply rejection ratio (PSRR), low output noise, and excellent line and load transient response with small 1  $\mu$ F ceramic input and output capacitors.

LDO2 is optimized to supply analog circuits because it offers better noise performance compared to LDO1. LDO1 should be used in applications where noise performance is not critical.

09665-092

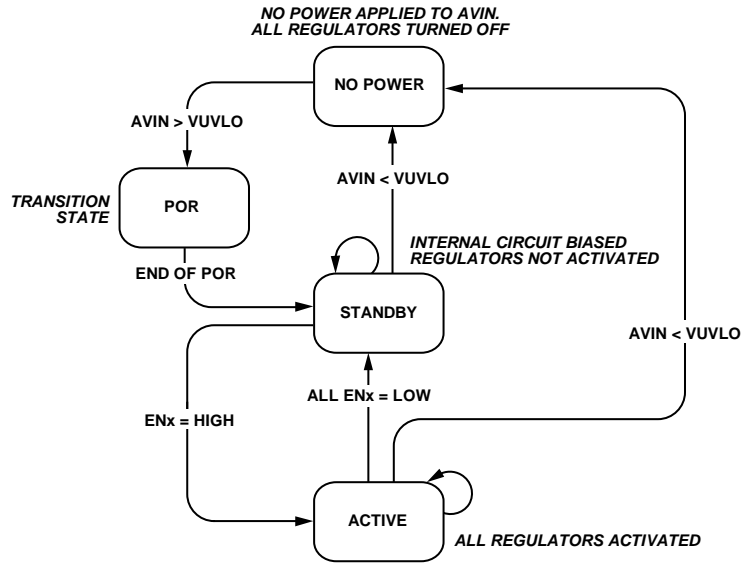

Figure 104. ADP5040 State Flow

019665-0168

## APPLICATIONS INFORMATION

### BUCK EXTERNAL COMPONENT SELECTION

Trade-offs between performance parameters such as efficiency and transient response are made by varying the choice of external components in the applications circuit, as shown in Figure 1.

#### Feedback Resistors

Referring to Figure 102, the total combined resistance for R1 and R2 is not to exceed 400 kΩ.

#### Inductor

The high switching frequency of the ADP5040 buck allows for the selection of small chip inductors. For best performance, use inductor values between 0.7 μH and 3.0 μH. Suggested inductors are shown in Table 8.

The peak-to-peak inductor current ripple is calculated using the following equation:

$$I_{RIPPLE} = \frac{V_{OUT} \times (V_{IN} - V_{OUT})}{V_{IN} \times f_{SW} \times L}$$

where:

$f_{SW}$  is the switching frequency.

$L$  is the inductor value.

The minimum dc current rating of the inductor must be greater than the inductor peak current. The inductor peak current is calculated using the following equation:

$$I_{PEAK} = I_{LOAD(MAX)} + \frac{I_{RIPPLE}}{2}$$

**Table 8. Suggested 1.0 μH Inductors**

Vendor	Model	Dimensions (mm)	I <sub>SAT</sub> (mA)	DCR (mΩ)
Murata	LQM2MPN1R0NG0B	2.0 × 1.6 × 0.9	1400	85
Murata	LQM18FN1R0M00B	3.2 × 2.5 × 1.5	2300	54
Tayo Yuden	CBC322ST1R0MR	3.2 × 2.5 × 2.5	2000	71
Coilcraft	XFL4020-102ME	4.0 × 4.0 × 2.1	5400	11
Coilcraft	XPL2010-102ML	1.9 × 2.0 × 1.0	1800	89
Toko	MDT2520-CN	2.5 × 2.0 × 1.2	1350	85

Inductor conduction losses are caused by the flow of current through the inductor, which has an associated internal dc resistance (DCR). Larger sized inductors have smaller DCR, which may decrease inductor conduction losses. Inductor core losses are related to the magnetic permeability of the core material. Because the buck is high switching frequency dc-to-dc converter, shielded ferrite core material is recommended for its low core losses and low EMI.

#### Output Capacitor

Higher output capacitor values reduce the output voltage ripple and improve load transient response. When choosing the capacitor value, it is also important to account for the loss of capacitance due to output voltage dc bias.

Ceramic capacitors are manufactured with a variety of dielectrics, each with a different behavior over temperature and applied voltage. Capacitors must have a dielectric adequate to ensure the minimum capacitance over the necessary temperature range and dc bias conditions. X5R or X7R dielectrics with a voltage rating of 6.3 V or 10 V are highly recommended for best performance. Y5V and Z5U dielectrics are not recommended for use with any dc-to-dc converter because of their poor temperature and dc bias characteristics.

The worst-case capacitance accounting for capacitor variation over temperature, component tolerance, and voltage is calculated using the following equation:

$$C_{EFF} = C_{OUT} \times (1 - TEMPCO) \times (1 - TOL)$$

where:

$C_{EFF}$  is the effective capacitance at the operating voltage.

$TEMPCO$  is the worst-case capacitor temperature coefficient.

$TOL$  is the worst-case component tolerance.

In this example, the worst-case temperature coefficient ( $TEMPCO$ ) over  $-40^{\circ}\text{C}$  to  $+85^{\circ}\text{C}$  is assumed to be 15% for an X5R dielectric. The tolerance of the capacitor ( $TOL$ ) is assumed to be 10%, and  $C_{OUT}$  is 9.2481 μF at 1.8 V, as shown in Figure 105.

Substituting these values in the equation yields

$$C_{EFF} = 9.24 \mu\text{F} \times (1 - 0.15) \times (1 - 0.1) = 7.07 \mu\text{F}$$

To guarantee the performance of the buck, it is imperative that the effects of dc bias, temperature, and tolerances on the behavior of the capacitors be evaluated for each application.

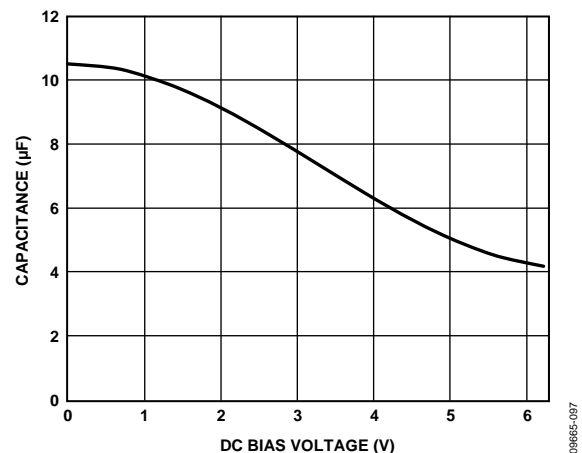

Figure 105. Typical Capacitor Performance

The peak-to-peak output voltage ripple for the selected output capacitor and inductor values is calculated using the following equation:

$$V_{RIPPLE} = \frac{I_{RIPPLE}}{8 \times f_{SW} \times C_{OUT}} \approx \frac{V_{IN}}{(2\pi \times f_{SW})^2 \times L \times C_{OUT}}$$

Capacitors with lower equivalent series resistance (ESR) are preferred to guarantee low output voltage ripple, as shown in the following equation:

$$ESR_{COUT} \leq \frac{V_{RIPPLE}}{I_{RIPPLE}}$$

The effective capacitance needed for stability, which includes temperature and dc bias effects, is a minimum of 7 μF and a maximum of 40 μF.

Table 9. Suggested 10 μF Capacitors

Vendor	Type	Model	Case Size	Voltage Rating (V)
Murata	X5R	GRM188R60J106	0603	6.3
Taiyo Yuden	X5R	JMK107BJ106MA-T	0603	6.3
TDK	X5R	C1608JB0J106K	0603	6.3
Panasonic	X5R	ECJ1VB0J106M	0603	6.3

The buck regulator requires 10 μF output capacitors to guarantee stability and response to rapid load variations and to transition in and out the PWM/PSM modes. In certain applications, where the buck regulator powers a processor, the operating state is known because it is controlled by software. In this condition, the processor can drive the MODE pin according to the operating state; consequently, it is possible to reduce the output capacitor from 10 μF to 4.7 μF because the regulator does not expect a large load variation when working in PSM mode (see Figure 106).

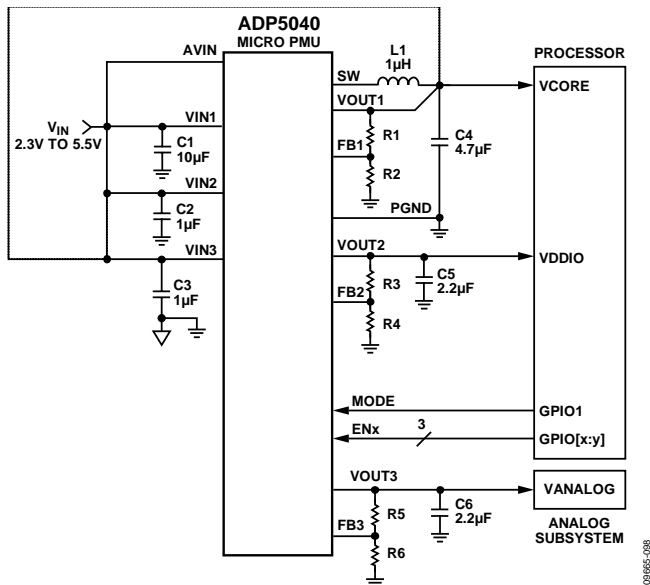

Figure 106. Processor System Power Management with PSM/PWM Control

**Input Capacitor**

A higher value input capacitor helps to reduce the input voltage ripple and improve transient response. Maximum input capacitor current is calculated using the following equation:

$$I_{CIN} \geq I_{LOAD(MAX)} \sqrt{\frac{V_{OUT}(V_{IN} - V_{OUT})}{V_{IN}}}$$

To minimize supply noise, place the input capacitor as close to the VIN pin of the buck as possible. As with the output capacitor, a low ESR capacitor is recommended.

The effective capacitance needed for stability, which includes temperature and dc bias effects, is a minimum of 3 μF and a maximum of 10 μF. A list of suggested capacitors is shown in Table 10.

Table 10. Suggested 4.7 μF Capacitors

Vendor	Type	Model	Case Size	Voltage Rating (V)
Murata	X5R	GRM188R60J475ME19D	0603	6.3
Taiyo Yuden	X5R	JMK107BJ475	0603	6.3
Panasonic	X5R	ECJ-0EB0J475M	0402	6.3

**LDO EXTERNAL COMPONENT SELECTION**

**Feedback Resistors**

Referring to Figure 103 the maximum value of Rb is not to exceed 200 kΩ.

**Output Capacitor**

The ADP5040 LDOs are designed for operation with small, space-saving ceramic capacitors, but they function with most commonly used capacitors as long as care is taken with the ESR value. The ESR of the output capacitor affects stability of the LDO control loop. A minimum of 0.70 μF capacitance with an ESR of 1 Ω or less is recommended to ensure stability of the LDO. Transient response to changes in load current is also affected by output capacitance. Using a larger value of output capacitance improves the transient response of the LDO to large changes in load current.

When operating at output currents higher than 200 mA a minimum of 2.2 μF capacitance with an ESR of 1 Ω or less is recommended to ensure stability of the LDO.

Table 11. Suggested 2.2 μF Capacitors

Vendor	Type	Model	Case Size	Voltage Rating (V)
Murata	X5R	GRM188B31A225K	0402	10.0
TDK	X5R	C1608JB0J225KT	0402	6.3
Panasonic	X5R	ECJ1VB0J225K	0402	6.3
Taiyo Yuden	X5R	JMK107BJ225KK-T	0402	6.3

**Input Bypass Capacitor**

Connecting 1 μF capacitors from VIN2 and VIN3 to ground reduces the circuit sensitivity to printed circuit board (PCB) layout, especially when long input traces or high source impedance is encountered. If greater than 1 μF of output capacitance is required, increase the input capacitor to match it.



Table 12. Suggested 1.0  $\mu\text{F}$  Capacitors

Vendor	Type	Model	Case Size	Voltage Rating (V)
Murata	X5R	GRM155R61A105ME15	0402	10.0
TDK	X5R	C1005JB0J105KT	0402	6.3
Panasonic	X5R	ECJ0E0J105K	0402	6.3
Taiyo Yuden	X5R	LMK105BJ105MV-F	0402	10.0

### Input and Output Capacitor Properties

Use any good quality ceramic capacitor with the [ADP5040](#) as long as it meets the minimum capacitance and maximum ESR requirements. Ceramic capacitors are manufactured with a variety of dielectrics, each with a different behavior over temperature and applied voltage. Capacitors must have a dielectric adequate to ensure the minimum capacitance over the necessary temperature range and dc bias conditions. X5R or X7R dielectrics with a voltage rating of 6.3 V or 10 V are recommended for best performance. Y5V and Z5U dielectrics are not recommended for use with any LDO because of their poor temperature and dc bias characteristics.

Figure 107 depicts the capacitance vs. voltage bias characteristic of a 0402 1  $\mu\text{F}$ , 10 V, X5R capacitor. The voltage stability of a capacitor is strongly influenced by the capacitor size and voltage rating. In general, a capacitor in a larger package or higher voltage rating exhibits better stability. The temperature variation of the X5R dielectric is about  $\pm 15\%$  over the  $-40^\circ\text{C}$  to  $+85^\circ\text{C}$  temperature range and is not a function of package or voltage rating.

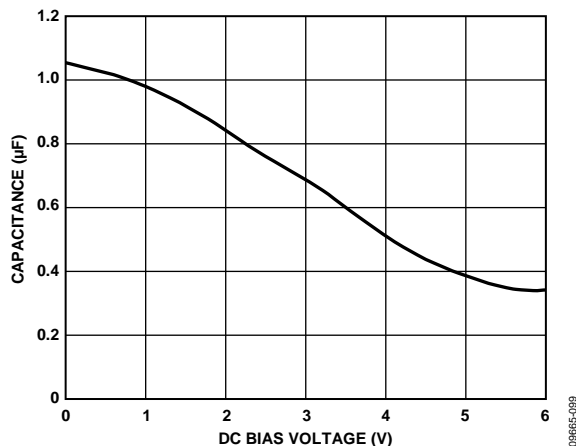

Figure 107. Capacitance vs. Voltage Characteristic

Use the following equation to determine the worst-case capacitance accounting for capacitor variation over temperature, component tolerance, and voltage.

$$C_{\text{EFF}} = C_{\text{BIAS}} \times (1 - \text{TEMPCO}) \times (1 - \text{TOL})$$

where:

$C_{\text{BIAS}}$  is the effective capacitance at the operating voltage.

$\text{TEMPCO}$  is the worst-case capacitor temperature coefficient.

$\text{TOL}$  is the worst-case component tolerance.

In this example, the worst-case temperature coefficient ( $\text{TEMPCO}$ ) over  $-40^\circ\text{C}$  to  $+85^\circ\text{C}$  is assumed to be 15% for an

X5R dielectric. The tolerance of the capacitor ( $\text{TOL}$ ) is assumed to be 10%, and  $C_{\text{BIAS}}$  is 0.94  $\mu\text{F}$  at 1.8 V as shown in Figure 107.

Substituting these values into the following equation yields:

$$C_{\text{EFF}} = 0.94 \mu\text{F} \times (1 - 0.15) \times (1 - 0.1) = 0.72 \mu\text{F}$$

Therefore, the capacitor chosen in this example meets the minimum capacitance requirement of the LDO over temperature and tolerance at the chosen output voltage.

To guarantee the performance of the [ADP5040](#), it is imperative that the effects of dc bias, temperature, and tolerances on the behavior of the capacitors be evaluated for each application.

### POWER DISSIPATION/THERMAL CONSIDERATIONS

The [ADP5040](#) is a highly efficient micropower management unit (micro PMU), and in most cases the power dissipated in the device is not a concern. However, if the device operates at high ambient temperatures and with maximum loading conditions, the junction temperature can reach the maximum allowable operating limit ( $125^\circ\text{C}$ ).

When the junction temperature exceeds  $150^\circ\text{C}$ , the [ADP5040](#) turns off all the regulators, allowing the device to cool down. Once the die temperature falls below  $135^\circ\text{C}$ , the [ADP5040](#) resumes normal operation.

This section provides guidelines to calculate the power dissipated in the device and to make sure the [ADP5040](#) operates below the maximum allowable junction temperature.

The efficiency for each regulator on the [ADP5040](#) is given by

$$\eta = \frac{P_{\text{OUT}}}{P_{\text{IN}}} \times 100\% \quad (1)$$

where:

$\eta$  is efficiency.

$P_{\text{IN}}$  is the input power.

$P_{\text{OUT}}$  is the output power.

Power loss is given by

$$P_{\text{LOSS}} = P_{\text{IN}} - P_{\text{OUT}} \quad (2a)$$

or

$$P_{\text{LOSS}} = P_{\text{OUT}} \times (1 - \eta) / \eta \quad (2b)$$

Power dissipation can be calculated in several ways. The most intuitive and practical way is to measure the power dissipated at the input and all the outputs. The measurements should be performed at the worst-case conditions (voltages, currents, and temperature). The difference between input and output power is dissipated in the device and the inductor. Use Equation 4 to derive the power lost in the inductor, and from this use Equation 3 to calculate the power dissipation in the [ADP5040](#) buck regulator.

A second method to estimate the power dissipation uses the efficiency curves provided for the buck regulator, whereas the power lost on a LDO is calculated using Equation 12. When the buck efficiency is known, use Equation 2b to derive the total power lost in the buck regulator and inductor. Use Equation 4



to derive the power lost in the inductor, and then calculate the power dissipation in the buck converter using Equation 3. Add the power dissipated in the buck and in the LDOs to find the total dissipated power.

Note that the buck efficiency curves are typical values and may not be provided for all possible combinations of  $V_{IN}$ ,  $V_{OUT}$ , and  $I_{OUT}$ . To account for these variations, it is necessary to include a safety margin when calculating the power dissipated in the buck.

A third way to estimate the power dissipation is analytical and involves modeling the losses in the buck circuit provided by Equation 8 to Equation 11 and the losses in the LDOs provided by Equation 12.

### Buck Regulator Power Dissipation

The power loss of the buck regulator is approximated by

$$P_{LOSS} = P_{DBUCK} + P_L \quad (3)$$

where:

$P_{DBUCK}$  is the power dissipation on the ADP5040 buck regulator.  
 $P_L$  is the inductor power losses.

The inductor losses are external to the device and they do not have any effect on the die temperature.

The inductor losses are estimated (without core losses) by

$$P_L \cong I_{OUT(RMS)}^2 \times DCR_L \quad (4)$$

where:

$DCR_L$  is the inductor series resistance.  
 $I_{OUT(RMS)}$  is the rms load current of the buck regulator.

$$I_{OUT(RMS)} = I_{OUT} \times \sqrt{1 + r/12} \quad (5)$$

where  $r$  is the normalized inductor ripple current.

$$R \approx V_{OUT} \times (1 - D) / (I_{OUT} \times L \times f_{SW}) \quad (6)$$

where:

$L$  is inductance.  
 $f_{SW}$  is switching frequency.  
 $D$  is duty cycle.

$$D = V_{OUT} / V_{IN} \quad (7)$$

The ADP5040 buck regulator power dissipation,  $P_{DBUCK}$ , includes the power switch conductive losses, the switch losses, and the transition losses of each channel. There are other sources of loss, but these are generally less significant at high output load currents, where the thermal limit of the application is. Equation 8 shows the calculation made to estimate the power dissipation in the buck regulator.

$$P_{DBUCK} = P_{COND} + P_{SW} + P_{TRAN} \quad (8)$$

The power switch conductive losses are due to the output current,  $I_{OUT1}$ , flowing through the PMOSFET and the NMOSFET power switches that have internal resistance,  $R_{DS(ON)-P}$  and  $R_{DS(ON)-N}$ . The amount of conductive power loss is found by:

$$P_{COND} = [R_{DS(ON)-P} \times D + R_{DS(ON)-N} \times (1 - D)] \times I_{OUT1}^2 \quad (9)$$

For the ADP5040, at 125°C junction temperature and  $V_{IN1} = 3.6$  V,  $R_{DS(ON)-P}$  is approximately 0.2  $\Omega$ , and  $R_{DS(ON)-N}$  is approximately 0.16  $\Omega$ . At  $V_{IN1} = 2.3$  V, these values change to 0.31  $\Omega$  and 0.21  $\Omega$ , respectively, and at  $V_{IN1} = 5.5$  V, the values are 0.16  $\Omega$  and 0.14  $\Omega$ , respectively.

Switching losses are associated with the current drawn by the driver to turn on and turn off the power devices at the switching frequency. The amount of switching power loss is given by:

$$P_{SW} = (C_{GATE-P} + C_{GATE-N}) \times V_{IN1}^2 \times f_{SW} \quad (10)$$

where:

$C_{GATE-P}$  is the PMOSFET gate capacitance.  
 $C_{GATE-N}$  is the NMOSFET gate capacitance.

For the ADP5040, the total of ( $C_{GATE-P} + C_{GATE-N}$ ) is approximately 150 pF.

The transition losses occur because the PMOSFET cannot be turned on or off instantaneously, and the SW node takes some time to slew from near ground to near  $V_{OUT1}$  (and from  $V_{OUT1}$  to ground). The amount of transition loss is calculated by:

$$P_{TRAN} = V_{IN1} \times I_{OUT1} \times (t_{RISE} + t_{FALL}) \times f_{SW} \quad (11)$$

where  $t_{RISE}$  and  $t_{FALL}$  are the rise time and the fall time of the switching node, SW. For the ADP5040, the rise and fall times of SW are in the order of 5 ns.

If the preceding equations and parameters are used for estimating the converter efficiency, note that the equations do not describe all of the converter losses, and the parameter values given are typical numbers. The converter performance also depends on the choice of passive components and board layout; therefore, a sufficient safety margin should be included in the estimate.

### LDO Regulator Power Dissipation

The power loss of a LDO regulator is given by:

$$P_{DLDO} = [(V_{IN} - V_{OUT}) \times I_{LOAD}] + (V_{IN} \times I_{GND}) \quad (12)$$

where:

$I_{LOAD}$  is the load current of the LDO regulator.  
 $V_{IN}$  and  $V_{OUT}$  are input and output voltages of the LDO, respectively.  
 $I_{GND}$  is the ground current of the LDO regulator.

Power dissipation due to the ground current is small and it can be ignored.

The total power dissipation in the ADP5040 simplifies to:

$$P_D = \{P_{DBUCK} + P_{DLDO1} + P_{DLDO2}\} \quad (13)$$

**Junction Temperature**

In cases where the board temperature,  $T_A$ , is known, the thermal resistance parameter,  $\theta_{JA}$ , can be used to estimate the junction temperature rise.  $T_J$  is calculated from  $T_A$  and  $P_D$  using the formula

$$T_J = T_A + (P_D \times \theta_{JA}) \tag{14}$$

The typical  $\theta_{JA}$  value for the 20-lead, 4 mm × 4 mm LFCSP is 38°C/W (see Table 6). A very important factor to consider is that  $\theta_{JA}$  is based on a 4-layer, 4 inch × 3 inch, 2.5 oz copper, as per JEDEC standard, and real applications may use different sizes and layers. To remove heat from the device, it is important to maximize the use of copper. Copper exposed to air dissipates heat better than copper used in the inner layers. The exposed pad (EP) should be connected to the ground plane with several vias as shown in Figure 109.

If the case temperature can be measured, the junction temperature is calculated by

$$T_J = T_C + (P_D \times \theta_{JC}) \tag{15}$$

where:

$T_C$  is the case temperature.

$\theta_{JC}$  is the junction-to-case thermal resistance provided in Table 6.

When designing an application for a particular ambient temperature range, calculate the expected ADP5040 power dissipation ( $P_D$ ) due to the losses of all channels by using Equation 8 to Equation 13. From this power calculation, the junction temperature,  $T_J$ , can be estimated using Equation 14.

The reliable operation of the buck regulator and the LDO regulator can be achieved only if the estimated die junction temperature of the ADP5040 (Equation 14) is less than 125°C. Reliability and mean time between failures (MTBF) is highly affected by increasing the junction temperature. Additional information about product reliability can be found in the [Analog Devices, Inc., Reliability Handbook](http://www.analog.com/reliability_handbook), which is available at [http://www.analog.com/reliability\\_handbook](http://www.analog.com/reliability_handbook).

**APPLICATION DIAGRAM**

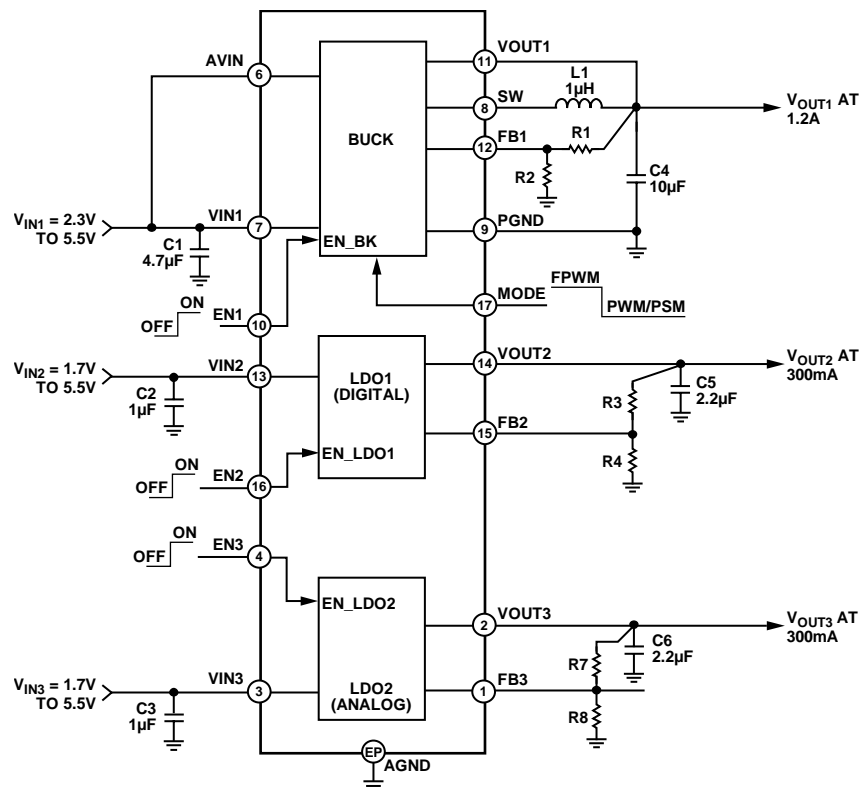

Figure 108. Application Diagram

09865-103

### PCB LAYOUT GUIDELINES

Poor layout can affect ADP5040 performance, causing electro-magnetic interference (EMI) and electromagnetic compatibility (EMC) problems, ground bounce, and voltage losses. Poor layout can also affect regulation and stability. A good layout is implemented using the following guidelines:

- Place the inductor, input capacitor, and output capacitor close to the IC using short tracks. These components carry high switching frequencies, and large tracks act as antennas.
- Route the output voltage path away from the inductor and SW node to minimize noise and magnetic interference.

- Maximize the size of ground metal on the component side to help with thermal dissipation.
- Use a ground plane with several vias connecting to the component side ground to further reduce noise interference on sensitive circuit nodes.

### SUGGESTED LAYOUT

See Figure 109 for an example layout.

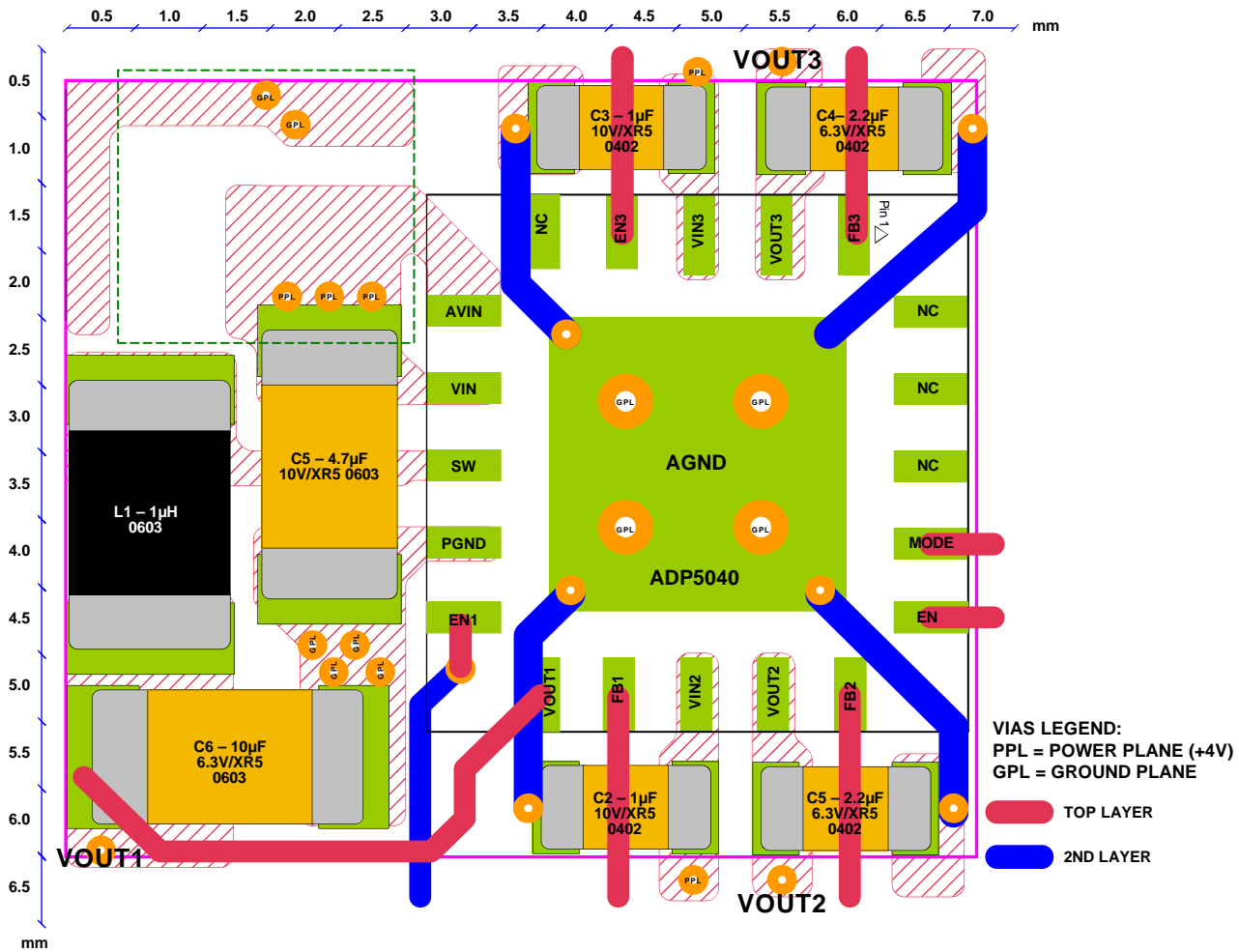

Figure 109. Evaluation Board Layout

098665-102

**BILL OF MATERIALS**

Table 13.

Reference	Value	Part Number	Vendor	Package
C1	4.7 $\mu$ F, X5R, 6.3 V	JMK107BJ475	Taiyo-Yuden	0603
C2, C3	1 $\mu$ F, X5R, 6.3 V	LMK105BJ105MV-F	Taiyo-Yuden	0402
C4	10 $\mu$ F, X5R, 6.3 V	JMK107BJ106MA-T	Taiyo-Yuden	0603
C5, C6	2.2 $\mu$ F, X5R, 6.3 V	JMK105BJ225MV-F	Taiyo-Yuden	0402
L1	1 $\mu$ H, 85 m $\Omega$ , 1400 mA	LQM2MPN1R0NG0B	Murata	2.0 $\times$ 1.6 $\times$ 0.9 (mm)
	1 $\mu$ H, 85 m $\Omega$ , 1350 mA	MDT2520-CN	Toko	2.5 $\times$ 2.0 $\times$ 1.2 (mm)
	1 $\mu$ H, 89 m $\Omega$ , 1800 mA	XPL2010-1102ML	Coilcraft	1.9 $\times$ 2.0 $\times$ 1.0 (mm)
IC1	3-regulator micro PMU	<a href="#">ADP5040</a>	Analog Devices	20-Lead LFCSP

## FACTORY PROGRAMMABLE OPTIONS

Table 14. Regulator Output Discharge Resistor Options

Selection	
0	All discharge resistors disabled
1	All discharge resistors enabled

Table 15. Under Voltage Lockout options

Selection	Min	Typ	Max	Unit
0	1.95	2.15	2.275	V
1	3.10	3.65	3.90	V

### OUTLINE DIMENSIONS

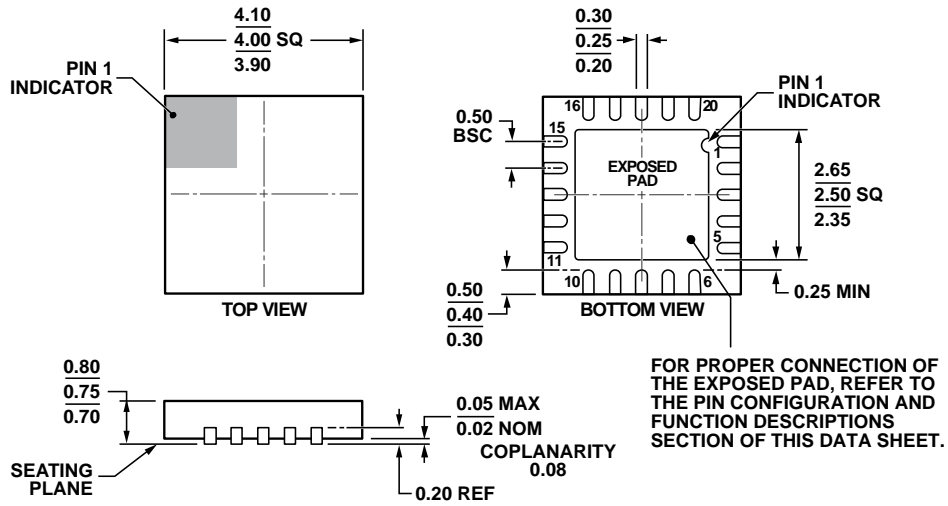

COMPLIANT TO JEDEC STANDARDS MO-220-WGGD.

Figure 110. 20-Lead Lead Frame Chip Scale Package [LFCSP\_WQ]  
 4 mm × 4 mm Body, Very Very Thin Quad  
 (CP-20-10)  
 Dimensions shown in millimeters

061609-B

### ORDERING GUIDE

Model <sup>1</sup>	UVLO	Active Pull-Down	Temperature Range	Package Description	Package Option
ADP5040ACPZ-1-R7 ADP5040CP-1-EVALZ	2.15 V	Enabled on all channels	T <sub>J</sub> = -40°C to +125°C	20-Lead LFCSP_WQ Evaluation Board	CP-20-10

<sup>1</sup> Z = RoHS Compliant Part.

**NOTES**

**NOTES**



**NOTES**