

Analog Devices Welcomes Hittite Microwave Corporation

NO CONTENT ON THE ATTACHED DOCUMENT HAS CHANGED



HMC1040* Product Page Quick Links

Last Content Update: 08/30/2016

[Comparable Parts](#)

View a parametric search of comparable parts

[Evaluation Kits](#)

- HMC1040LP3C Evaluation Board

[Documentation](#)

Application Notes

- AN-1363: Meeting Biasing Requirements of Externally Biased RF/Microwave Amplifiers with Active Bias Controllers
- Broadband Biasing of Amplifiers General Application Note
- MMIC Amplifier Biasing Procedure Application Note
- Thermal Management for Surface Mount Components General Application Note

Data Sheet

- HMC1040 Data Sheet

[Tools and Simulations](#)

- HMC1040 S-Parameters

[Reference Materials](#)

Quality Documentation

- Package/Assembly Qualification Test Report: LP3, LP4, LP5 & LP5G (QTR: 2014-00145)
- Semiconductor Qualification Test Report: PHEMT-L (QTR: 2013-00266)

[Design Resources](#)

- HMC1040 Material Declaration
- PCN-PDN Information
- Quality And Reliability
- Symbols and Footprints

[Discussions](#)

View all HMC1040 EngineerZone Discussions

[Sample and Buy](#)

Visit the product page to see pricing options

[Technical Support](#)

Submit a technical question or find your regional support number

* This page was dynamically generated by Analog Devices, Inc. and inserted into this data sheet. Note: Dynamic changes to the content on this page does not constitute a change to the revision number of the product data sheet. This content may be frequently modified.

THIS PAGE INTENTIONALLY LEFT BLANK



HMC1040LP3CE

GaAs pHEMT MMIC LOW NOISE AMPLIFIER, 24 - 43.5 GHz

Typical Applications

This HMC1040LP3BE is ideal for:

- Point-to-Point Radios
- Test Instrumentation
- SatCom Transponders & VSAT
- Industrial Sensors
- EW & ECM Subsystems

Features

- Low Noise Figure: 2.2 dB
- High Gain: 23 dB
- P1dB Output Power: +12 dBm
- Single Supply: +2.5V @ 70 mA
- Output IP3: +22 dBm
- 50 Ohm Matched Input/Output
- 16 Lead 3x3 mm SMT Package: 16mm²

Functional Diagram

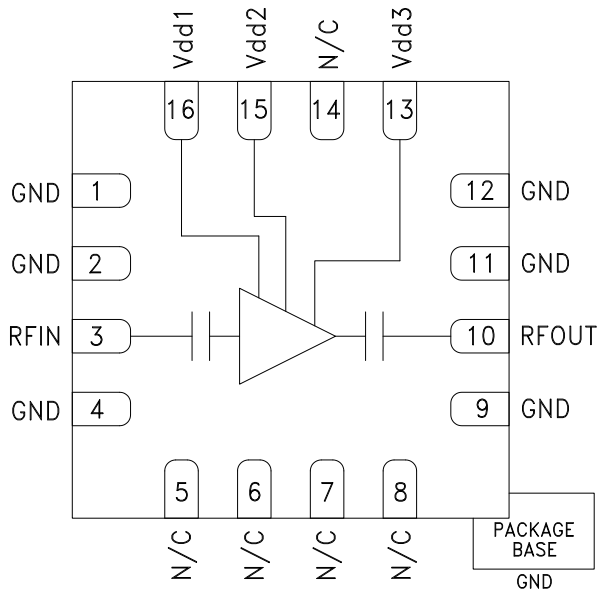

General Description

The HMC1040LP3CE is a self-biased GaAs MMIC Low Noise Amplifier housed in a leadless 3x3 mm plastic surface mount package. The amplifier operates between 24 and 43.5 GHz, delivering 23 dB of small signal gain, 2.2 dB noise figure, and output IP3 of +22 dBm, while requiring only 70 mA from a +2.5 V supply. The P1dB output power of +12 dBm enables the LNA to function as a LO driver for many of Hittite's balanced, I/Q and image reject mixers. The HMC1040LP3CE features I/Os that are DC blocked and internally matched to 50 Ohms, and is ideal for high capacity microwave radios and VSAT applications.

Electrical Specifications, $T_A = +25^\circ\text{C}$, $V_{dd1} = V_{dd2} = V_{dd3} = +2.5\text{V}$, $I_{dd} = 70\text{mA}$

Parameter	Min.	Typ.	Max.	Min.	Typ.	Max.	Min.	Typ.	Max.	Units
Frequency Range	24 - 27.5			27.5 - 33.5			33.5 - 43.5			GHz
Gain [1]	22	25		20	23		17	20		dB
Gain Variation over Temperature		0.022			0.021			0.021		dB / °C
Noise Figure [1]		2.7	3.2		2.2	2.7		2.7	3.2	dB
Input Return Loss		11			12			10		dB
Output Return Loss		16			13			10		dB
Output Power for 1 dB Compression		12			12			12		dBm
Saturated Output Power (P _{sat})		14			14			14		dBm
Output Third Order Intercept (IP3)		22			22			24		dBm
Supply Current (I _{dd}) (V _{dd} = 2.5V)		70	85		70	85		70	85	mA

[1] Board loss subtracted out.

GaAs pHEMT MMIC LOW NOISE AMPLIFIER, 24 - 43.5 GHz

Broadband Gain & Return Loss [1]

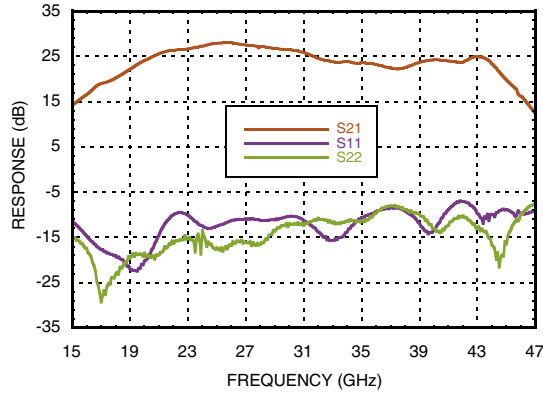

Gain vs. Temperature [1]

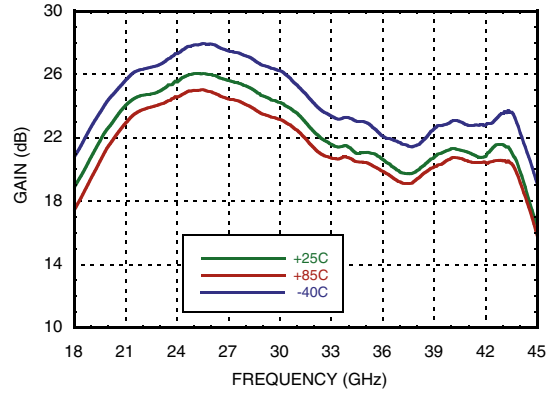

Input Return Loss vs. Temperature

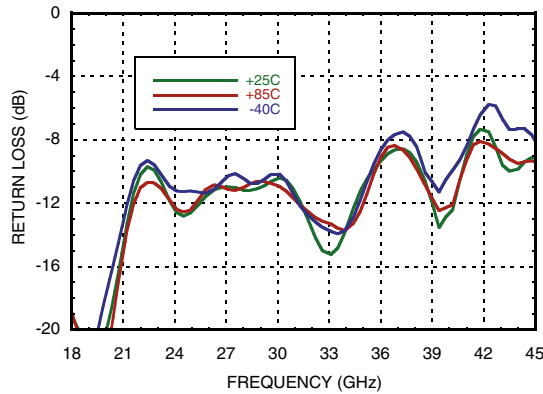

Output Return Loss vs. Temperature

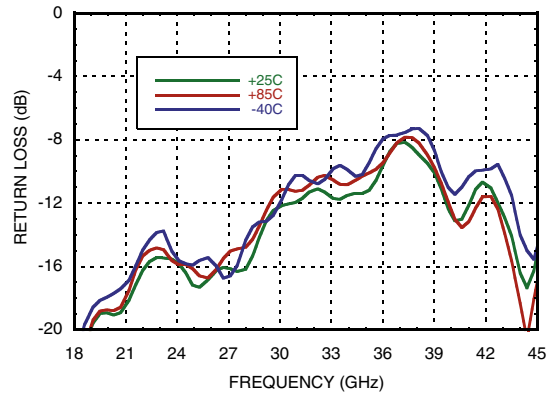

Noise Figure vs. Temperature [1]

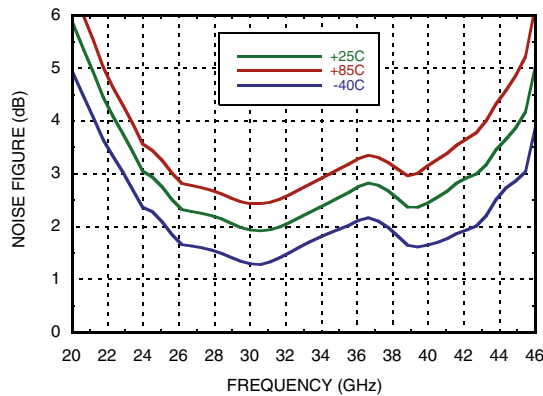

Output IP3 vs. Temperature

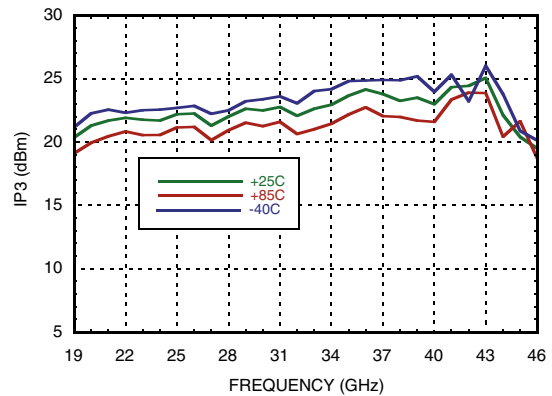

[1] Board loss subtracted out, gain only.



**GaAs pHEMT MMIC LOW NOISE
AMPLIFIER, 24 - 43.5 GHz**

AMPLIFIERS - LOW NOISE - SMT

P1dB vs. Temperature

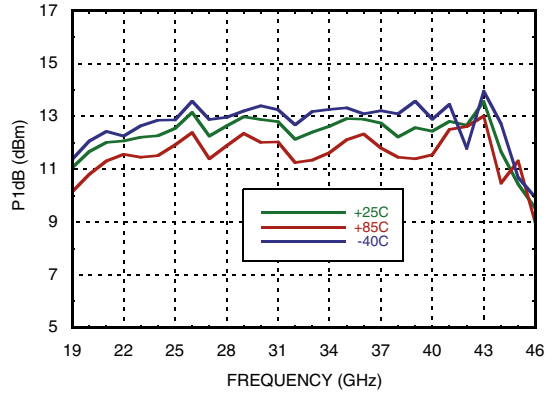

Psat vs. Temperature

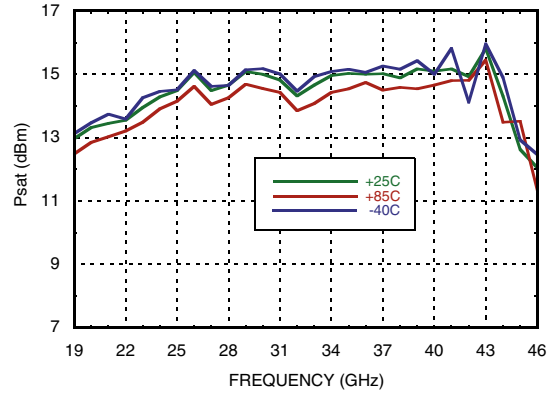

Reverse Isolation vs. Temperature

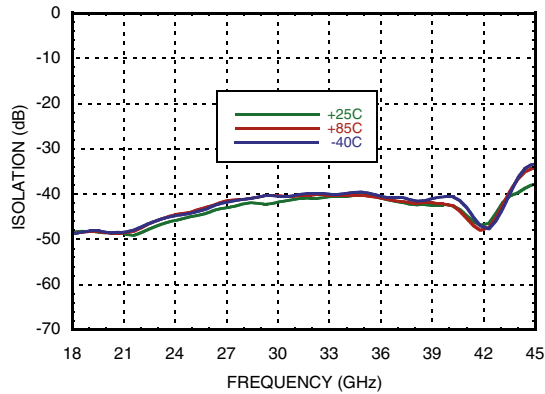

Power Compression @ 25 GHz

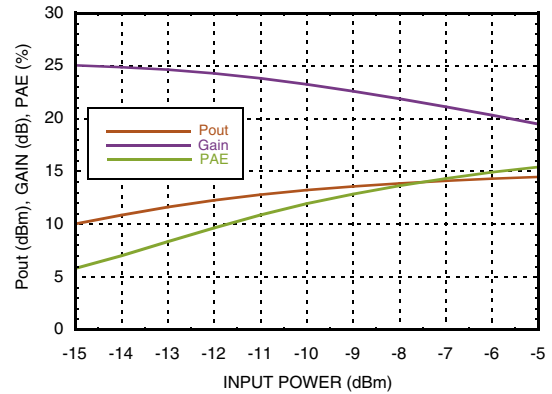

Power Compression @ 33 GHz

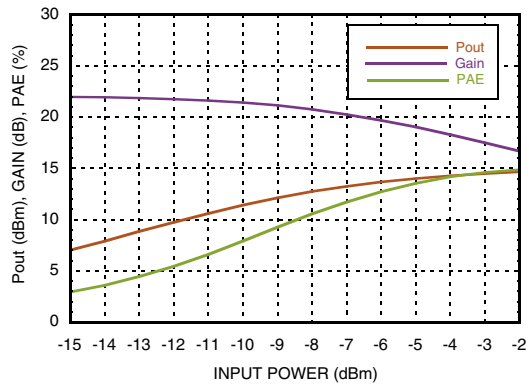

Power Compression @ 42 GHz

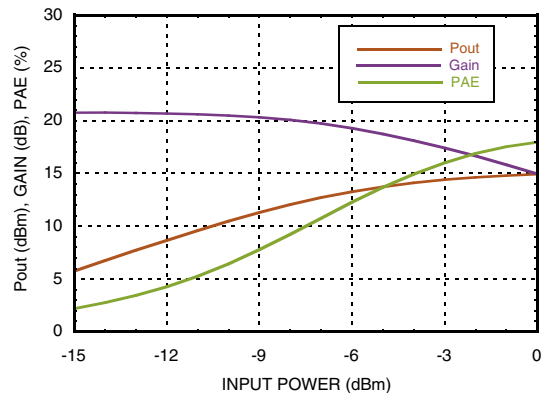



GaAs pHEMT MMIC LOW NOISE AMPLIFIER, 24 - 43.5 GHz

Current vs. Input Power @ 33 GHz

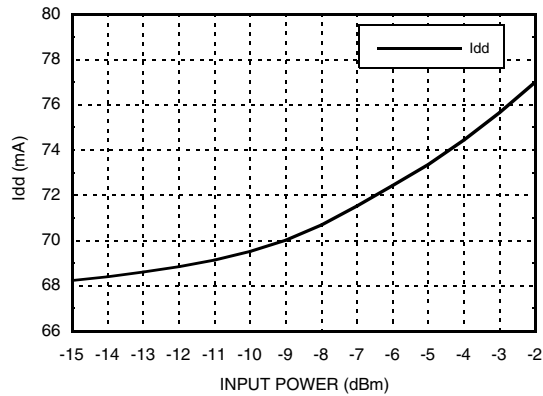

Absolute Maximum Ratings

Drain Bias Voltage	+4V
RF Input Power	+5 dBm
Channel Temperature	175 °C
Continuous P _{diss} (T = 85 °C) (derate 5.46 mW/°C above 85 °C)	0.49 W
Thermal Resistance (Channel to ground paddle)	183 °C/W
Storage Temperature	-65 to +150 °C
Operating Temperature	-40 to +85 °C
ESD Sensitivity (HBM)	Class 0, 100 V



ELECTROSTATIC SENSITIVE DEVICE
OBSERVE HANDLING PRECAUTIONS

Outline Drawing

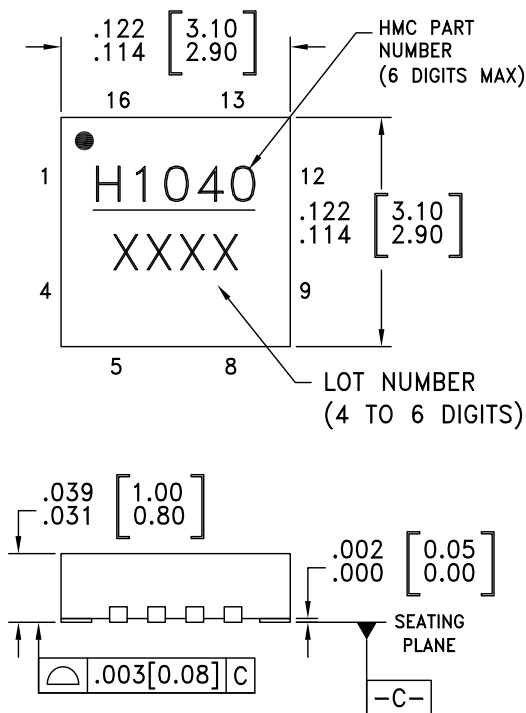

BOTTOM VIEW

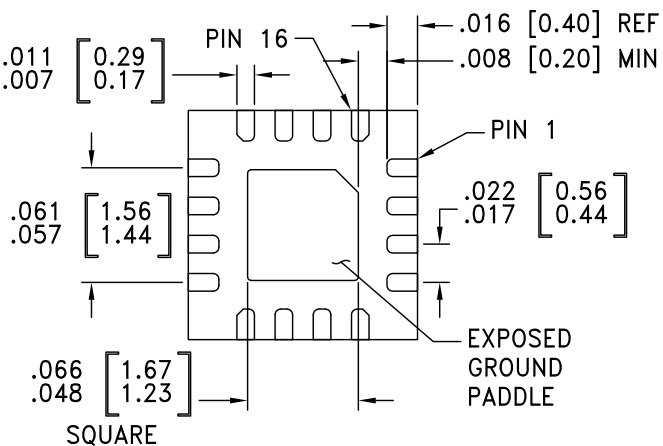

NOTES:

1. PACKAGE BODY MATERIAL: LOW STRESS INJECTION MOLDED PLASTIC SILICA AND SILICON IMPREGNATED.
2. LEAD AND GROUND PADDLE MATERIAL: COPPER ALLOY.
3. LEAD AND GROUND PADDLE PLATING: 100% MATTE TIN
4. DIMENSIONS ARE IN INCHES [MILLIMETERS].
5. LEAD SPACING TOLERANCE IS NON-CUMULATIVE.
6. PAD BURR LENGTH SHALL BE 0.15mm MAX. PAD BURR HEIGHT SHALL BE 0.05mm MAX.
7. PACKAGE WARP SHALL NOT EXCEED 0.05mm
8. ALL GROUND LEADS AND GROUND PADDLE MUST BE SOLDERED TO PCB RF GROUND.
9. REFER TO HITTITE APPLICATION NOTE FOR SUGGESTED PCB LAND PATTERN.

Package Information

Part Number	Package Body Material	Lead Finish	MSL Rating	Package Marking ^[2]
HMC1040LP3CE	RoHS-compliant Low Stress Injection Molded Plastic	100% matte Sn	MSL1 ^[1]	H1040 XXXX

[1] Max peak reflow temperature of 260 °C

[2] 4-Digit lot number XXXX



Pin Descriptions

Pin Number	Function	Description	Interface Schematic
1, 2, 4, 9, 11, 12	GND	These pins and package bottom must be connected to RF/DC ground.	
3	RFIN	This pin AC coupled and matched to 50 Ohms	
5-8, 14	N/C	The pins are not connected internally; however, all data shown herein was measured with these pins connected to RF/DC ground externally.	
10	RFOUT	This pin AC coupled and matched to 50 Ohms	
13, 15, 16	Vdd3, Vdd2, Vdd1	Drain bias voltages for the amplifier. See Application Circuit for required external components.	

Application Circuit

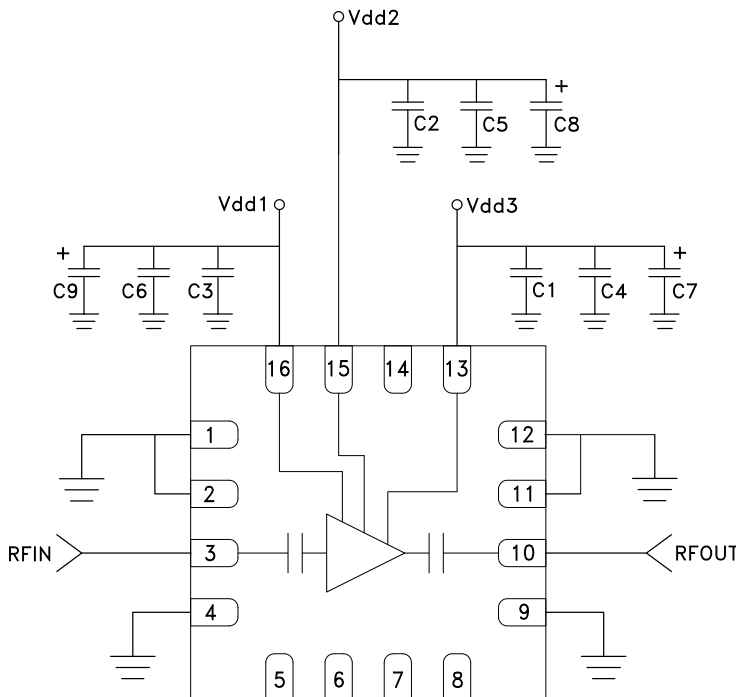

Capacitor	Value
C1 - C3	100 pF
C4 - C6	10 nF
C7 - C9	4.7 μF

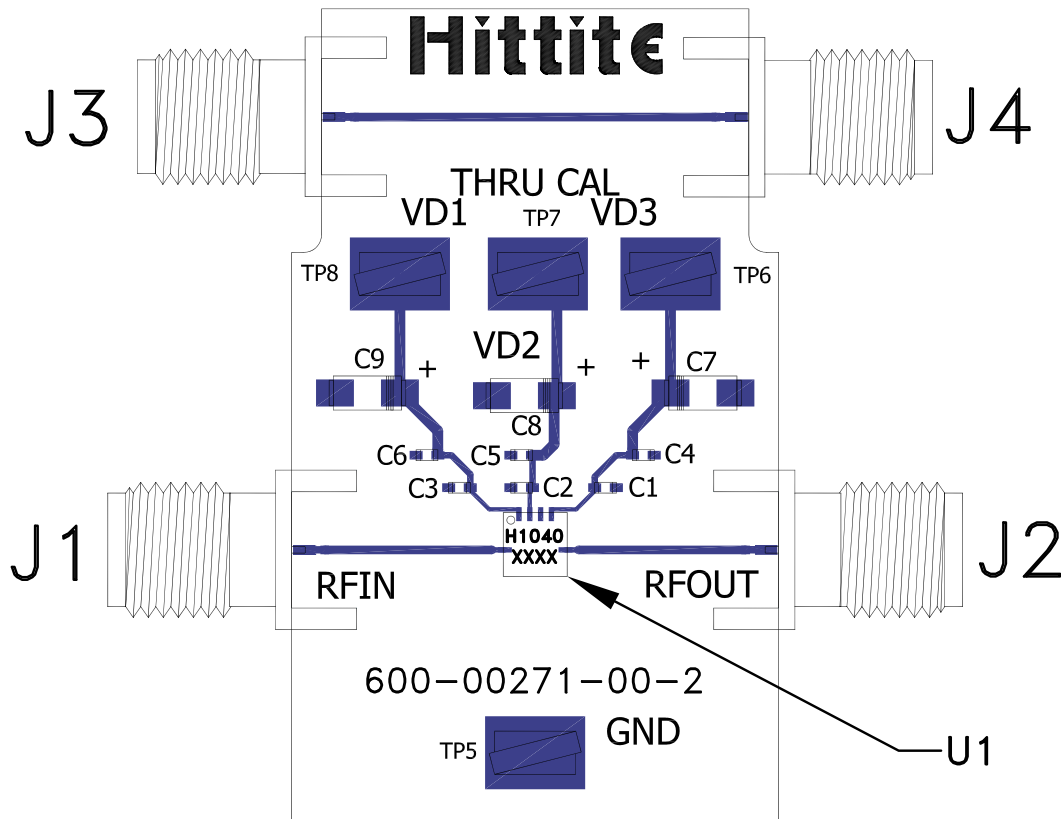
Evaluation PCB

List of Material for Evaluation PCB EVAL01-HMC1040LP3CE [1]

Item	Description
J1-J4	2.92 mm Connectors
TP5-TP8	Test Points DC Pin
C1 - C3	100 pF Capacitor, 0402 Pkg.
C4 - C6	10 nF Capacitor, 0402 Pkg.
C7 - C9	4.7 μ F Capacitor, Tantalum
U1	HMC1040LP3CE Amplifier
PCB [2]	600-00271-00-2 Evaluation PCB

[1] Reference this number when ordering complete evaluation PCB

[2] Circuit Board Material: Rogers 4350 or Arlon 25FR

The circuit board used in this application should use RF circuit design techniques. Signal lines should have 50 Ohm impedance while the package ground leads and exposed paddle should be connected directly to the ground plane similar to that shown. A sufficient number of via holes should be used to connect the top and bottom ground planes. The evaluation board should be mounted to an appropriate heat sink. The evaluation circuit board shown is available from Hittite upon request.