



FAN6208

Secondary-Side Synchronous Rectifier Controller for LLC Topology

Features

- Specialized SR Controller for LLC or LC Resonant Converters
- Secondary-Side Timing Detection with Timing Estimator
- Gate-Shrink Function to Prevent Shoot-Through During Load and Line Transient
- Green-Mode Function for Higher Efficiency at Light-Load Condition
- Programmable Dead Time between Primary-Side Gate Drive Signal and SR Drive Signal
- Advanced Output-Short / Overload Protection Based on the Feedback Information
- Internal Over-Temperature Protection (OTP)
- V_{DD} Pin Over-Voltage Protection (OVP)

Applications

- LCD TV
- PC Power
- Open-Frame SMPS

Description

FAN6208 is a synchronous rectification (SR) controller for isolated LLC or LC resonant converters that can drive two individual SR MOSFETs emulating the behavior of rectifier diodes. FAN6208 measures the SR conduction time of each switching cycle by monitoring the drain-to-source voltage of each SR and determines the optimal timing of the SR gate drive. FAN6208 uses the change of opto-coupler diode current to adaptively shrink the duration of SR gate drive signals during load transients to prevent shoot-through. To improve light-load efficiency, Green-Mode operation is employed, which disables the SR drive signals, minimizing gate drive power consumption at light-load condition.

Optimal timing circuits and protection functions are integrated in an 8-pin SOP package, which allows high-efficiency power supply design with fewer components.

Related Resources

- [FAN6208 Product Folder](#)

Ordering Information

Part Number	Operating Temperature Range	Package	Packing Method
FAN6208MY	-40°C to +105°C	8-Pin Small Outline Package (SOP)	Tape & Reel

Application Diagram

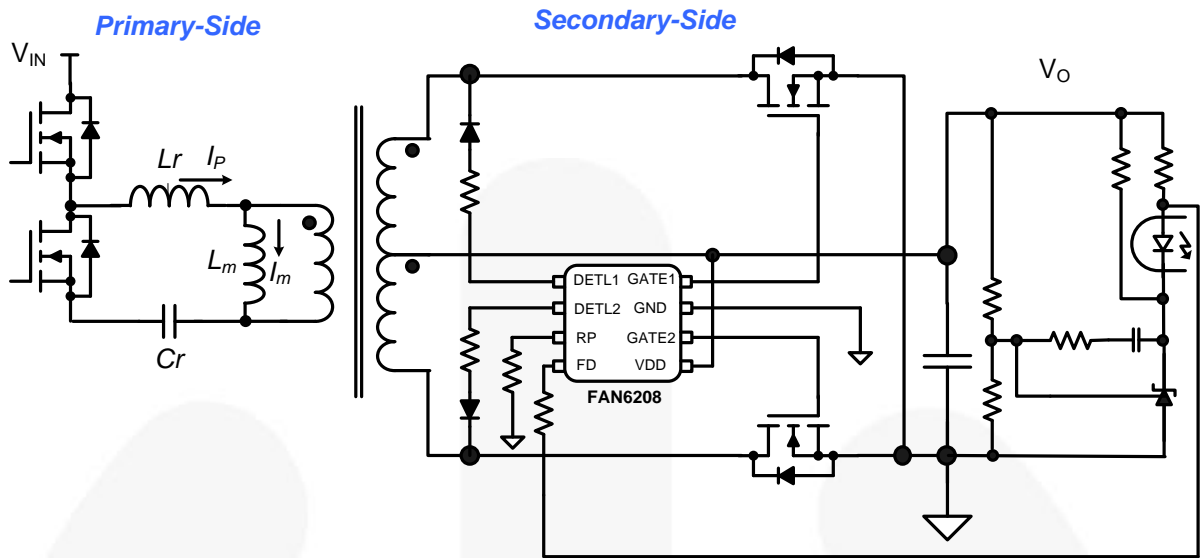

Figure 1. Typical Application

Block Diagram

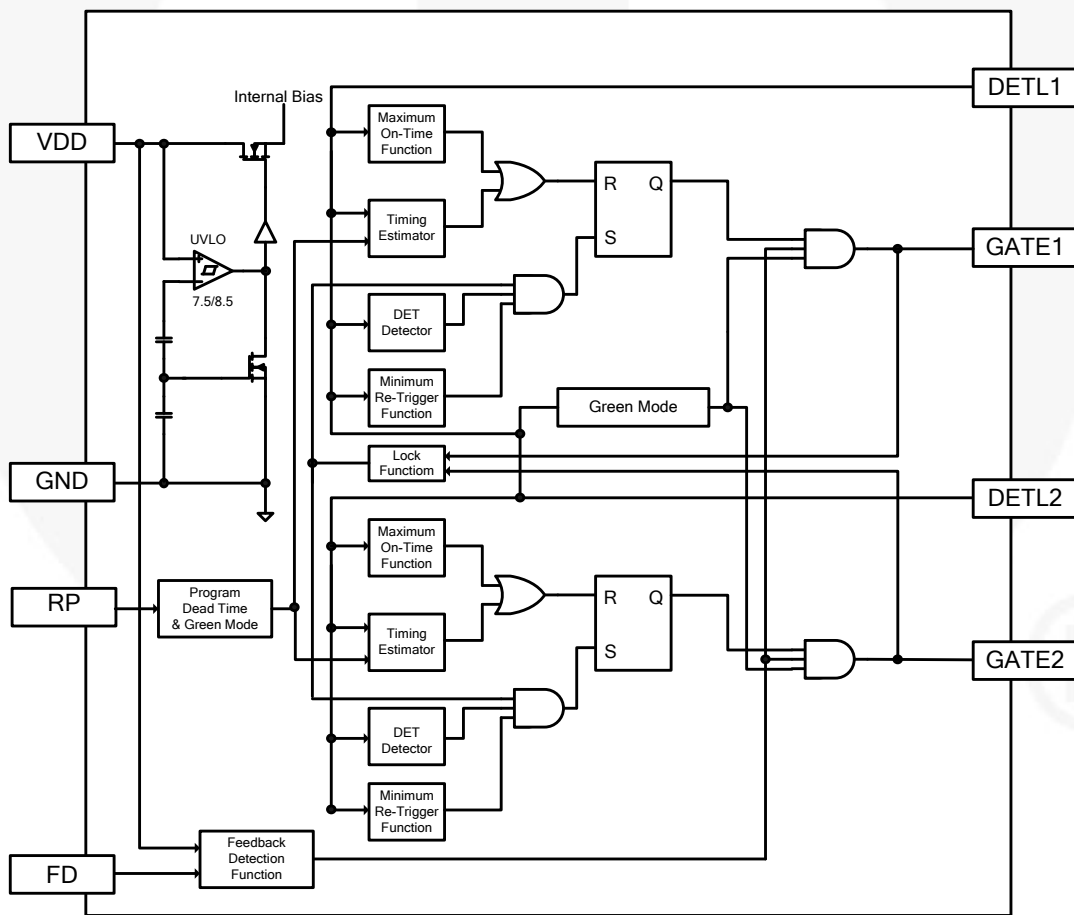
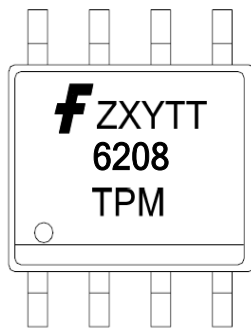

Figure 2. Block Diagram

Marking Information



F- Fairchild Logo
 Z- Plant Code
 X- Year Code
 Y- Week Code
 TT: Die Run Code
 T - Package Type (M = SOP)
 P - Y: Green Package
 M - Manufacture Flow Code

Figure 3. Top Mark

Pin Configuration

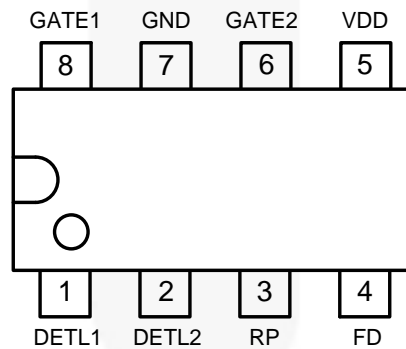

Figure 4. Pin Assignments

Pin Definitions

Pin #	Name	Description
1	DETL1	Low Detect provides low-voltage detection of V_{DS} of SR MOSFET1.
2	DETL2	Low Detect provides low-voltage detection of V_{DS} of SR MOSFET2.
3	RP	Dead Time Programming Resistor programs H/L frequency version and dead time.
4	FD	Feedback Detection is used for short-circuit protection and gate shrink.
5	VDD	Power Supply
6	GATE2	Driver Output. The totem-pole output driver for driving the SR MOSFET2.
7	GND	Ground
8	GATE1	Driver Output. The totem-pole output driver for driving the SR MOSFET1.

Absolute Maximum Ratings

Stresses exceeding the absolute maximum ratings may damage the device. The device may not function or be operable above the recommended operating conditions and stressing the parts to these levels is not recommended. In addition, extended exposure to stresses above the recommended operating conditions may affect device reliability. The absolute maximum ratings are stress ratings only.

Symbol	Parameter	Min.	Max.	Unit
V _{DD}	Supply Voltage		30	V
V _{FD}	Voltage on FD Pin		30	V
V _{LV}	Voltage on DETL1, DETL2, RP Pins	-0.3	7.0	V
P _D	Power Dissipation	350 mW at T _A =90°C	1000 mW at T _A =25°C	
Θ _{JA}	Junction-to-Ambient Thermal Resistance		130	°C/W
Ψ _{JT}	Junction-to-Top Thermal Characteristics		45	°C/W
T _J	Operating Junction Temperature	Internally Limited		°C
T _{STG}	Storage Temperature Range	-55	+150	°C
T _L	Lead Temperature (Wave Soldering or IR, 10 Seconds)		+260	°C
ESD	Human Body Model, JESD22-A114		6	kV
	Charged Device Model, JESD22-C101		2	

Recommended Operating Conditions

The Recommended Operating Conditions table defines the conditions for actual device operation. Recommended operating conditions are specified to ensure optimal performance to the datasheet specifications. Fairchild does not recommend exceeding them or designing to Absolute Maximum Ratings.

Symbol	Parameter	Min.	Max.	Unit
T _A	Operating Ambient Temperature	-40	+105	°C

Electrical Characteristics

$V_{DD}=20\text{ V}$, $T_A=25^\circ\text{C}$, unless otherwise specified. All voltages are with respect to GND unless otherwise noted.

Symbol	Parameter	Condition	Min.	Typ.	Max.	Unit
VDD Section						
V_{DD}	DC Supply Voltage		V_{TH-OFF}		28	V
I_{DD-OP1}	Operating Current	$V_{DD}=12\text{ V}$, DETL=50 KHZ, $C_L=6\text{ nF}$, $R_{RP}=24\text{ K}\Omega$	7.0	8.5	10.0	mA
I_{DD-OP2}	Operating Current	$V_{DD}=12\text{ V}$, DETL=100 KHZ	2.4	3.2	4.0	mA
I_{DD-ST}	Startup Current	$V_{DD}=8\text{ V}$	180	300	500	μA
V_{TH-ON1} V_{TH-ON2}	On Threshold Voltage		9.3	9.7	10.1	V
$V_{TH-OFF1}$ $V_{TH-OFF2}$	Off Threshold Voltage		8.3	8.8	9.3	V
$V_{DD-OVP1}$ $V_{DD-OVP2}$	V_{CC} Over-Voltage Protection		26	27	28	V
$V_{DD-OVP-HYS1}$ $V_{DD-OVP-HYS2}$	V_{CC} Over-Voltage Protection Hysteresis		1.3	1.8	2.3	V
t_{OVP1}, t_{OVP2}	V_{CC} Over-Voltage-Protection Debounce		30	60	100	μs
DETL Section						
V_{DETL1} V_{DETL2}	Threshold Voltage for LOW Detection of DETL	$V_{DD}=12\text{ V}$, DETL=50 KHZ, $C_L=6\text{ nF}$, $R_{RP}=24\text{ K}\Omega$	1.7	2.0	2.3	V
$t_{SR-ON-DETL1}$ $t_{SR-ON-DETL2}$	Delay from DETL LOW to SR Gate Turn-On	$t_{DB}+ t_{PD}+ t_R$	300	350	400	ns
$V_{DETL-FLOATING1}$ $V_{DETL-FLOATING2}$	DETL Floating Voltage	$V_{DD}=12\text{ V}$, DETL Pin Floating	4.5			V
$I_{DETL-SOURCE1}$ $I_{DETL-SOURCE2}$	DETL Source Current	$V_{DETL1}=0\text{ V}$	40	50	60	μA
$t_{DETL_Green_LF1}$ $t_{DETL_Green_LF2}$	DETL LOW Time Threshold for Green Mode at Low-Frequency Operation	$V_{RP} < 1.5\text{ V}$	3.50	3.75	4.00	μs
$t_{DET(L)_Green_HF1}$ $t_{DET(L)_Green_HF2}$	DETL LOW Time Threshold for Green Mode at High-Frequency Operation	$V_{RP} > 1.5\text{ V}$	1.75	1.90	2.05	μs
Thermal Shutdown						
$T_{SHUTDOWN}$	Shutdown Temperature	Temperature Rising, $V_{DD}=15\text{ V}$		140		$^\circ\text{C}$
	Hysteresis			20		
$T_{STARTUP}$	Startup Temperature	Before Startup		120		

Continued on the following page...

Electrical Characteristics

$V_{DD}=20\text{ V}$, $T_A=25^\circ\text{C}$, unless otherwise specified. All voltages are with respect to GND unless otherwise noted.

Symbol	Parameter	Condition	Min.	Typ.	Max.	Unit
Gate Section						
$V_{Z1} V_{Z2}$	Gate Output Voltage Maximum (Clamping)	$V_{DD}=20\text{ V}$	10	12	14	V
$V_{OL1} V_{OL2}$	Gate Output Voltage LOW	$V_{DD}=12\text{ V}$; $I_O=100\text{ mA}$			0.5	V
$V_{OH1} V_{OH2}$	Gate Output Voltage HIGH	$V_{DD}=12\text{ V}$; $I_O=100\text{ mA}$	9			V
$t_{R1} t_{R2}$	Rising Time	$V_{DD}=12\text{ V}$; $C_L=6\text{ nF}$; $V_{GATE}=2\text{ V to }9\text{ V}$	30	70	120	ns
$t_{F1} t_{F2}$	Falling Time	$V_{DD}=12\text{ V}$; $C_L=6\text{ nF}$; $V_{GATE}=9\text{ V to }2\text{ V}$	30	50	70	ns
$t_{PD_HIGH_DETL1}$ $t_{PD_HIGH_DETL2}$	Propagation Delay to Gate Output HIGH (DETL Trigger)	$t_R: 0\text{ V}\sim 2\text{ V}$, $V_{DD}=12\text{ V}$ (DET Floating)		120		ns
$t_{PD_LOW_DETL1}$ $t_{PD_LOW_DETL2}$	Propagation Delay to Gate Output LOW (DETL Trigger)	$t_F: 100\%\sim 90\%$, $V_{DD}=12\text{ V}$ (DET Floating)		120		ns
t_{ON_MAX1} t_{ON_MAX2}	Maximum On-Time	Trim Maximum On-Time	9.0	10.5	12.0	μs
$t_{INHIBIT_LF1}$ $t_{INHIBIT_LF2}$	Gate Inhibit Time (from Turn-Off to Next Turn-On)	$V_{RP} < 1.5\text{ V}$	1.8	2.1	2.5	μs
$t_{INHIBIT_HF1}$ $t_{INHIBIT_HF2}$	Gate Inhibit Time (from Turn-Off to Next Turn-On)	$V_{RP} > 1.5\text{ V}$	1.25	1.45	1.70	μs
$t_{BLANKING1}$ $t_{BLANKING2}$	Blanking Time for SR Turn-Off Triggered by DETL High (Minimum On-Time)			300		ns
K_R	Gate ON-Time Increase Rate Between Two Consecutive Cycles	$t_{ON}(n) / t_{ON}(n-1) \%$		140		%
Timing Estimator Section						
t_{DW}	Detection Window for Insufficient Dead Time (from Gate Turn-Off to DETL HIGH)		80	125	150	ns
$t_{SHRINK-DT}$	Gate Shrink Time by Insufficient Dead Time	$R_{RP}=20\text{ K}\Omega$, $t_{DETL}=5\text{ }\mu\text{s}$	1.00	1.25	1.50	μs
t_{DEAD}	Dead Time by Timing Estimator (70 kHz ~ 140 kHz, $V_{RP} < 1.5\text{ V}$)	$t_{DETL}=4\text{ }\mu\text{s}$, $R_{RP}=20\text{ K}\Omega$	210	300	390	ns
		$t_{DETL}=6\text{ }\mu\text{s}$, $R_{RP}=20\text{ K}\Omega$	570	720	870	
	Dead Time by Timing Estimator (160kHz ~ 240 kHz, $V_{RP} > 1.5\text{ V}$)	$t_{DETL}=2.5\text{ }\mu\text{s}$, $R_{RP}=43\text{ K}\Omega$	220	320	420	
		$t_{DETL}=3.8\text{ }\mu\text{s}$, $R_{RP}=43\text{ K}\Omega$	560	670	780	
t_{DB}	DETL HIGH-to-LOW Debounce Time for Gate Turn-on Trigger			150		ns
$t_{SHRINK-RNG}$	Gate Shrink by DETL Ringing around Zero			1.2		μs
t_{Green_DH}	DETL Pull-HIGH Time Threshold for Green Mode		18	24	30	μs

Continued on the following page...

Electrical Characteristics

$V_{DD}=20\text{ V}$, $T_A=25^\circ\text{C}$, unless otherwise specified. All voltages are with respect to GND unless otherwise noted.

Symbol	Parameter	Conditions	Min.	Typ.	Max.	Units
Feedback Detection (FD) Section						
$\Delta V1\% \Delta V2\%$	Feedback Increase Threshold for Gate Shrink	$[(V_{DD}-V_{FD})_{n+1}/(V_{DD}-V_{FD})_n]$		120		%
$t_{SHRINK-FD}$	Gate Shrink by Feedback Detection			1.4		μs
$t_{D-SHRINK-FD}$	Gate-Shrink Duration by Feedback Detection		60	90	120	μs
$V_{DD}-V_{FD.SCP}$	Short-Circuit Protection (SCP) Threshold by Feedback Detection		200	270	340	mV
t_{DB-SCP}	Debounce Time for Short-Circuit Protection (SCP)		12	16	20	μs
RP Section						
I_{RP}	RP Source Current		38.5	41.5	44.5	μA
V_{RPO}	RP Open Protect		3.40	3.65	3.90	V
V_{RPS}	RP Short Protect		0.25	0.30	0.35	V
t_{RPOS}	RP Open/Short Debounce		1.6	2.0	2.4	μs
V_{RPHL}	H/L Frequency Threshold		1.40	1.46	1.52	V

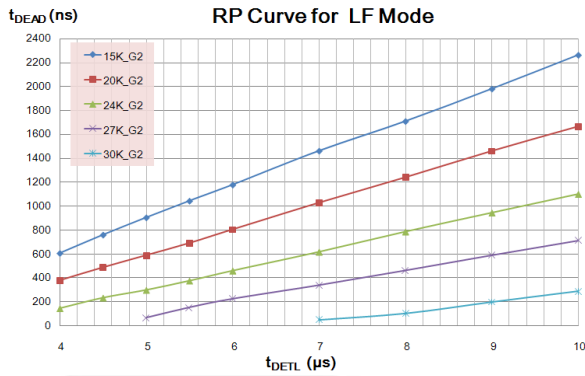

Figure 5. t_{DEAD} vs. t_{DET_L} RP Curve for LF Mode

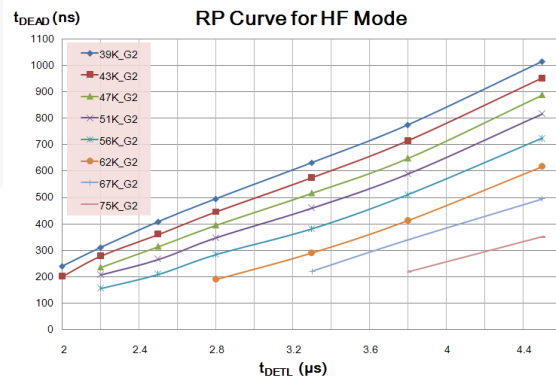

Figure 6. t_{DEAD} vs. t_{DET_L} RP Curve for HF Mode

Function Description

Operation Principle

FAN6208 is a secondary-side synchronous rectifier controller for LLC or LC resonant converters that drive two synchronous rectifier MOSFETs. Figure 7 is the simplified circuit diagram of an LLC converter. The FAN6208 determines SR MOSFET turn-on/off timing by detecting the drain-to-source voltage of each SR MOSFET. The key waveforms for LLC resonant converter for below resonance and above resonance are shown in Figure 8 and Figure 9, respectively.

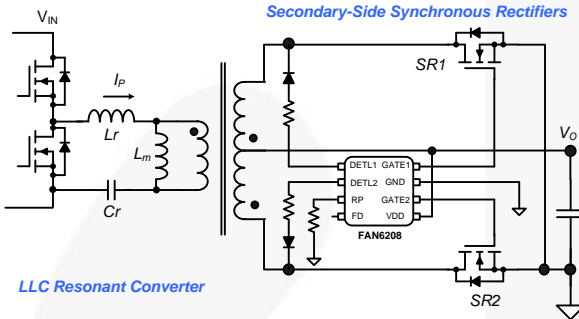

Figure 7. Simplified Schematic of LLC Converter

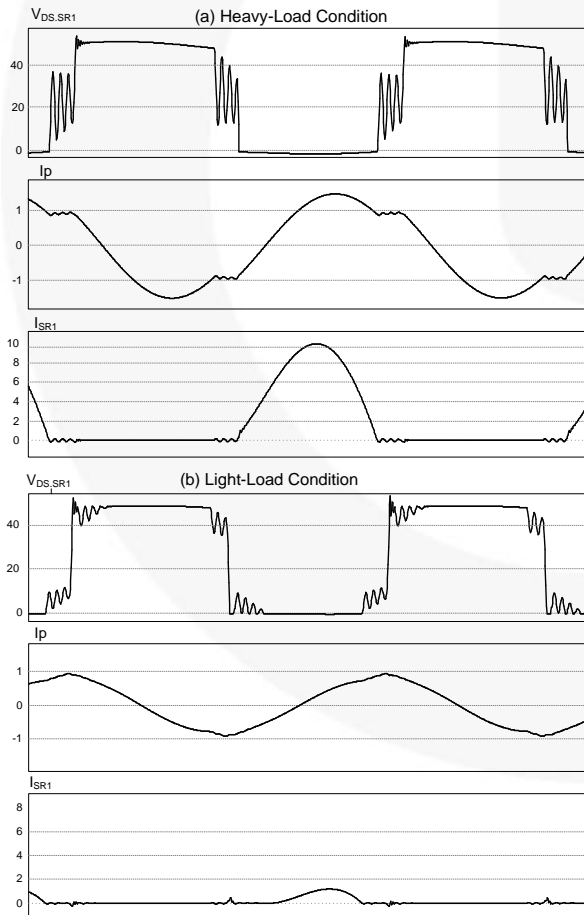

Figure 8. Key Waveforms of LLC Resonant Converter for Below Resonance Operation

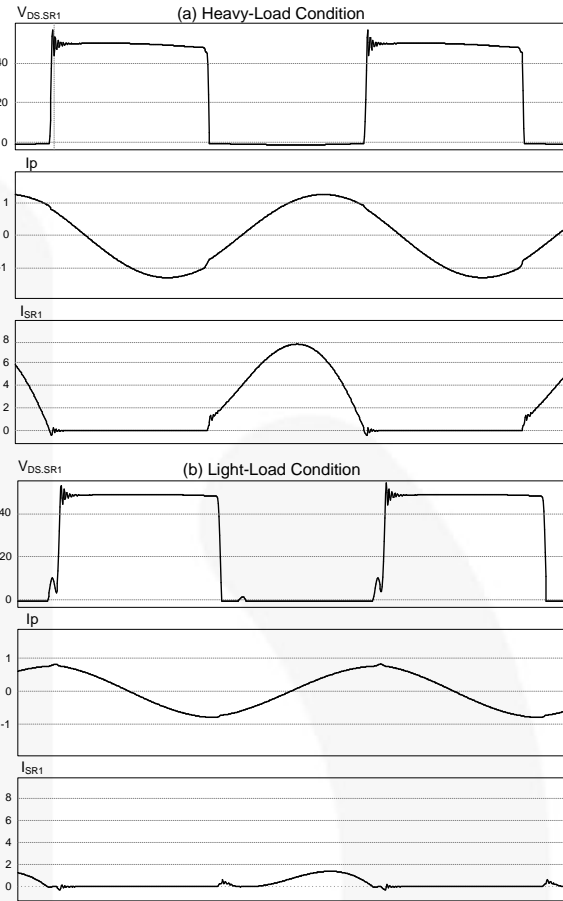

Figure 9. Key Waveforms of LLC Resonant Converter for Above Resonance Operation

Timing Estimator

Figure 10 shows the timing diagram for FAN6208. Once the body diode of SR begins conducting, the drain-to-source voltage drops to zero, which causes DETL pin voltage to drop to zero. FAN6208 turns on the MOSFET after $t_{ON-ON-DETL}$ (about 350 ns), when voltage on DETL drops below 2 V. As depicted in Figure 11, the turn-on delay (after $t_{SR-ON-DETL}$) is the sum of debounce time (150 ns) and propagation delay (200 ns).

FAN6208 measures the SR conduction duration (t_{DETL}), during which DETL stays lower than 2 V, and uses this information to determine the turn-off instant of SR gates of the next switching cycle. The turn-off timing is obtained by subtracting a dead time (t_{DEAD}) from the measured SR conduction duration of the previous switching cycle. The dead time can be programmed using a resistor on the RP pin and the relationship between the dead time and SR conduction duration (t_{DETL}) for different resistor values on RP pin is given in Figure 5.

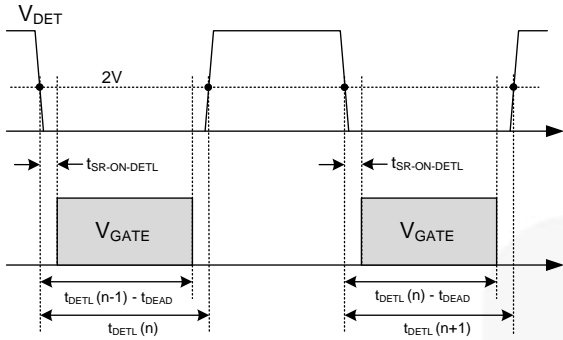

Figure 10. SR Gate Timing Diagram

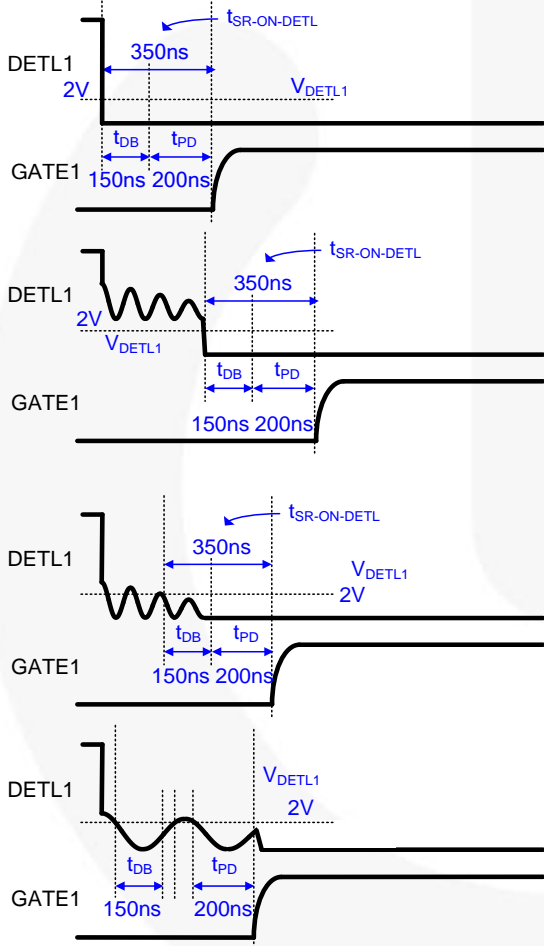

Figure 11. DETL Debounce (Blanking) Time

Gate-Shrink Functions

In normal operation, the turn-off instant is determined by subtracting a dead time (t_{DEAD}) from the measured SR conduction duration of the previous switching cycle, as shown in Figure 10. This allows proper driving timing for SR MOSFETs when the converter is in steady state and the switching frequency does not change much. However, this control method may cause shoot-through of SR MOSFETs when the switching frequency

increases fast and switching transition of the primary-side MOSFETs takes place before the turn-off command of SR is given. To prevent the shoot-through, FAN6208 has gate-shrink functions. Gate shrink occurs under three conditions:

(a) When insufficient dead time is detected in the previous switching cycle. When the DETL goes HIGH within 125 ns of detection window after SR gate is turned off, the SR gate drive signal in the next switching cycle is reduced by $t_{SHRINK-DT}$ (about 1.25 μ s) to increase the dead time, as shown in Figure 12.

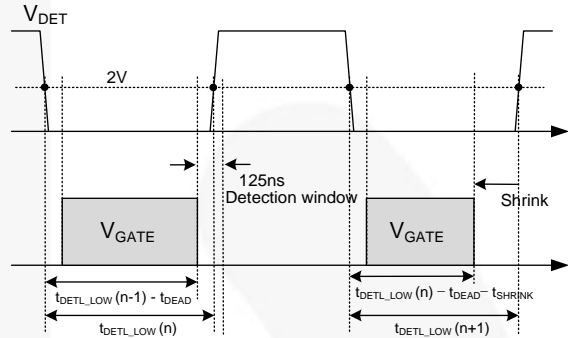

Figure 12. Gate Shrink by Minimum Dead Time Detection Window

(b) When the feedback information changes fast. FAN6208 monitors the current through the opto-coupler diode by measuring the voltage across the resistor in series with the opto-coupler diode, as depicted in Figure 13. If the feedback current through the opto-coupler diode increases by more than 20% of the feedback current of the previous switching cycle, the SR gate signal is shrunk by $t_{SHRINK-FD}$ (about 1.4 μ s) for $t_{D-SHRINK-FD}$ (about 90 μ s), as shown in Figure 14.

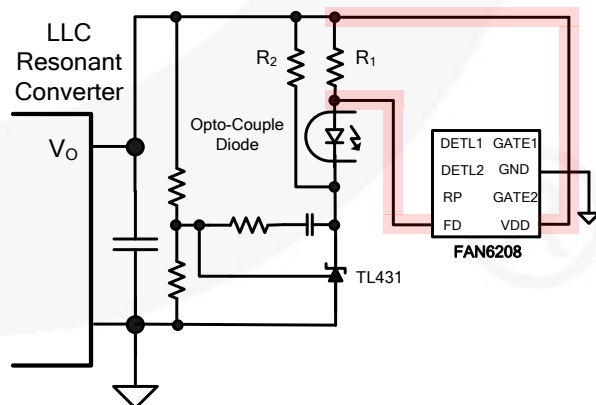

Figure 13. Typical Application Circuit

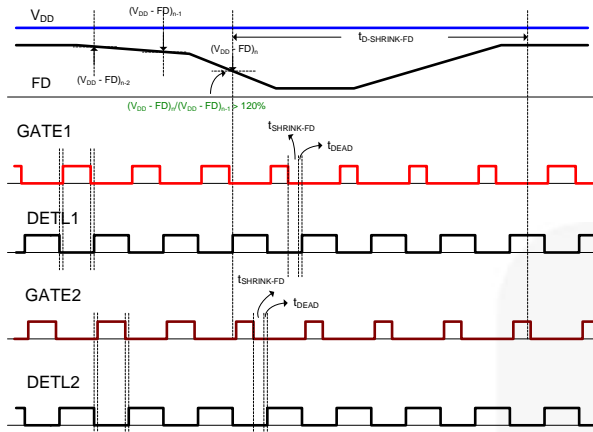

Figure 14. Gate Shrink by Feedback Detection

(c) When the DETL voltage has ringing around zero. As depicted in Figure 8, the drain voltage of SR has ringing around zero at light-load condition after the switching transition of the primary-side switches. When DETL voltage rises above 2 V within 350 ns after DETL voltage drops to zero and stays above 2 V longer than 150 ns, the gate is shrunk by 1.2 μ s ($t_{SHRINK-RNG}$), as shown in Figure 15.

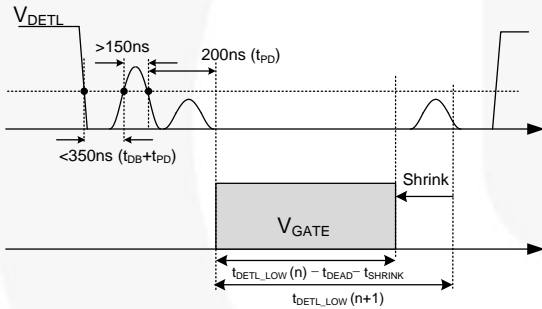

Figure 15. Gate Shrink by DETL Voltage Ringing Around Zero

RP Pin Function

The RP pin programs the level of green mode and t_{DEAD} . Figure 16 shows how the mode is selected by the voltage on the RP pin (open protection, short protection, and HF/LF mode). When R_{RP} is less than 36 $K\Omega$, FAN6208 operates in low-frequency mode. Green mode is enabled when t_{DETL} is smaller than 3.75 μ s. When R_{RP} is larger than 36 $K\Omega$, high-frequency mode is selected and green mode is enabled for $t_{DETL} < 1.90 \mu$ s. t_{DEAD} can be also adjusted by a resistor on the RP pin. Figure 5 shows the relationship between t_{DEAD} and t_{DETL} for different RP resistors.

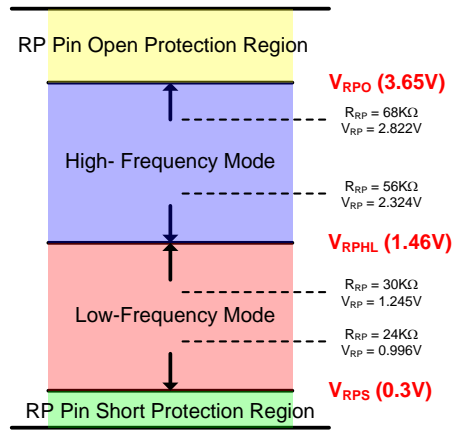

Figure 16. RP Pin Operation

To handle abnormal conditions for IC pins, the RP pin also provides open/short protection. When V_{RP} is less than V_{RPS} (0.3 V) or V_{RP} is higher than V_{RPO} (3.65 V), the protection is triggered. Figure 17 shows the RP pin short protection timing sequence. If $V_{RP} < V_{RPS}$ (0.3 V) for longer than t_{RPOS} (2 μ s), FAN6208 is disabled. Figure 18 shows the RP pin open protection timing sequence. If $V_{RP} > V_{RPO}$ (3.65 V) for longer than t_{RPOS} (2 μ s), FAN6208 is disabled.

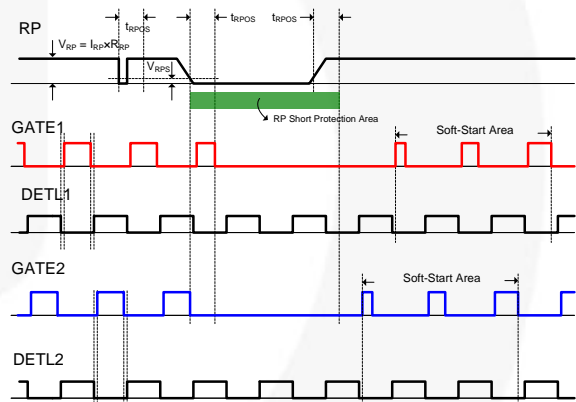

Figure 17. RP Pin Short Protection

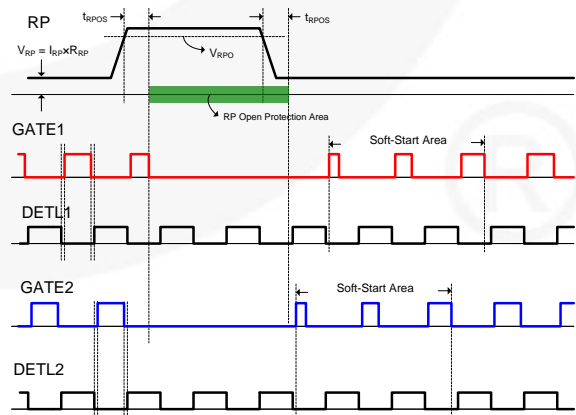

Figure 18. RP Pin Open Protection

Green Mode

Switching frequency increases in LLC topology at light-load condition, which increases the power consumption for the SR gate drive. Green mode reduces power loss at light load. FAN6208 has two ways to enable green mode. Green mode is triggered when DETL voltage is pulled LOW for less than 3.75 μs (LF mode) or 1.90 μs (HF mode) for seven switching cycles. FAN6208 resumes normal SR gate driving when DETL voltage is pulled LOW for longer than 3.75 μs (LF mode) or 1.90 μs (HF mode) for seven switching cycles.

When DETL voltage is pulled HIGH for longer than 24 μs . This occurs when the LLC resonant converter operates in burst mode (skipping mode).

Short-Circuit Protection

As depicted in Figure 13, FAN6208 monitors the current through the opto-coupler diode by measuring the voltage across the resistor in series with the opto-coupler diode. When the output of the power supply is short circuited, the output voltage drops and the cathode of the shunt regulator (KA431) is saturated to HIGH. No current flows through the opto coupler diode. The output short protection is triggered when the voltage between V_{DD} and FD is smaller than 0.3 V, as shown in Figure 19.

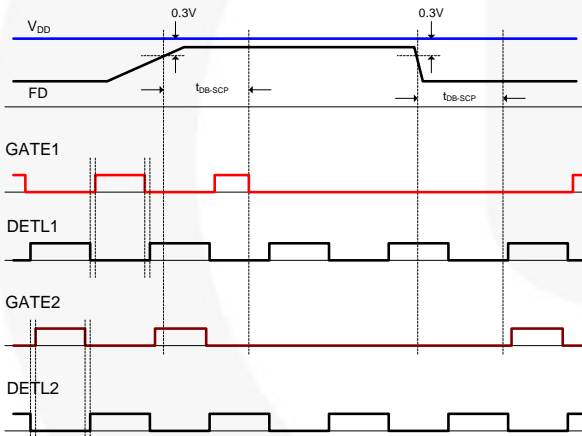

Figure 19. Output Short Protection by Feedback Detection

V_{DD} Pin Over-Voltage Protection

Over-voltage conditions are usually caused by an open feedback loop. V_{DD} over-voltage protection prevents damage of SR MOSFET. When the voltage on the V_{DD} pin exceeds 27 V, FAN6208 disables gate output.

Internal Over-Temperature Protection

Internal over-temperature protection prevents the SR gate from fault triggering in high temperatures. If the temperature is over 140°C, the SR gate is disabled until the temperature drops below 120°C.

Typical Performance Characteristics

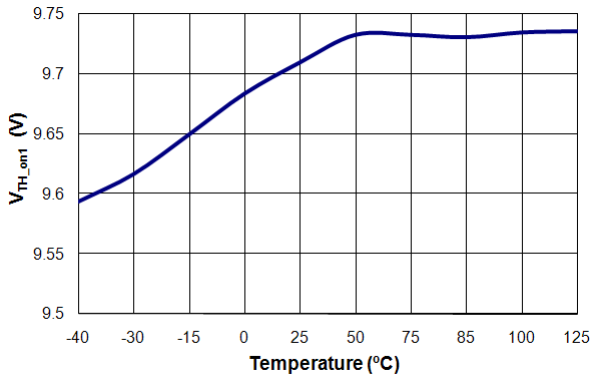

Figure 20. V_{TH_ON1} vs. T_A

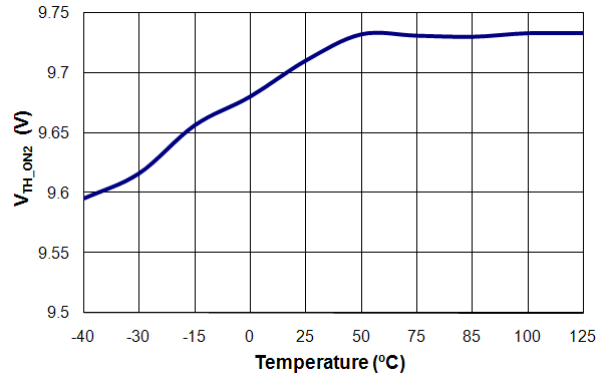

Figure 21. V_{TH_ON2} vs. T_A

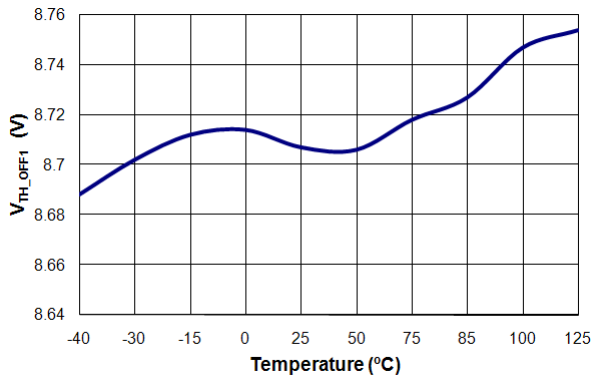

Figure 22. V_{TH_OFF1} vs. T_A

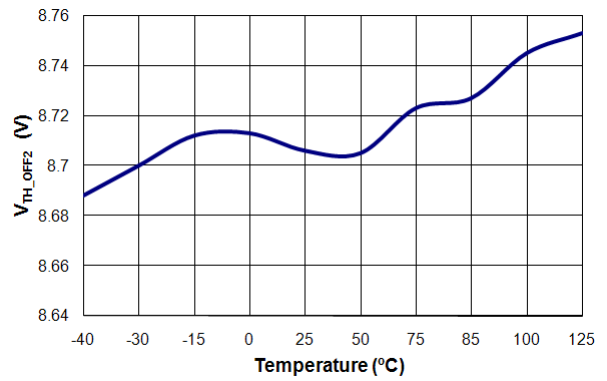

Figure 23. V_{TH_OFF2} vs. T_A

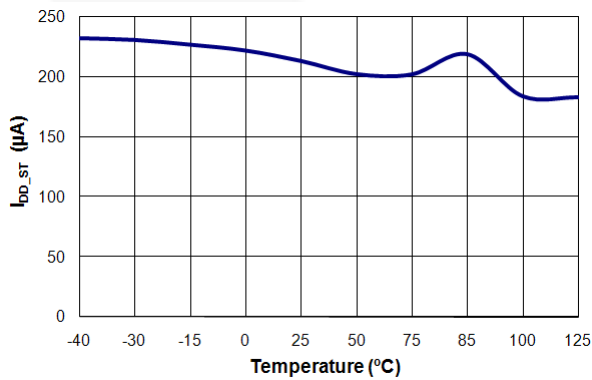

Figure 24. I_{DD_ST} vs. T_A

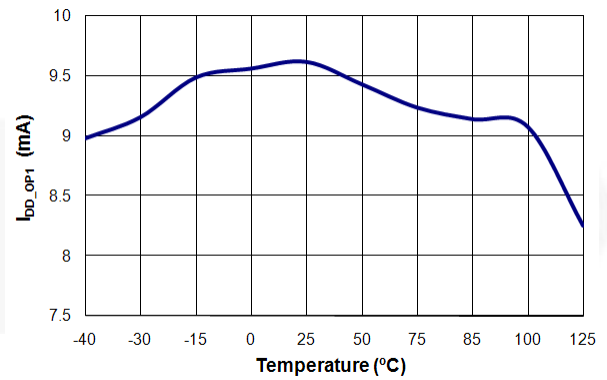

Figure 25. I_{DD_OP1} vs. T_A

Typical Performance Characteristics (Continued)

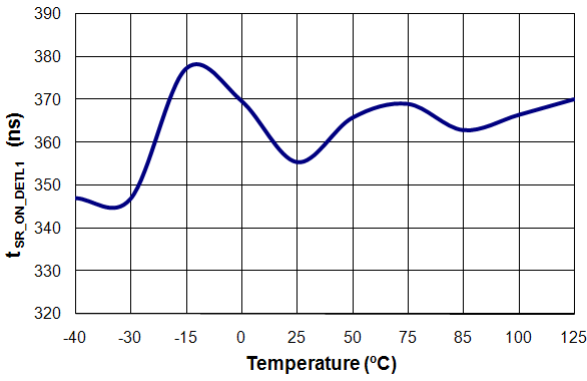

Figure 26. $t_{SR_ON_DET1}$ vs. T_A

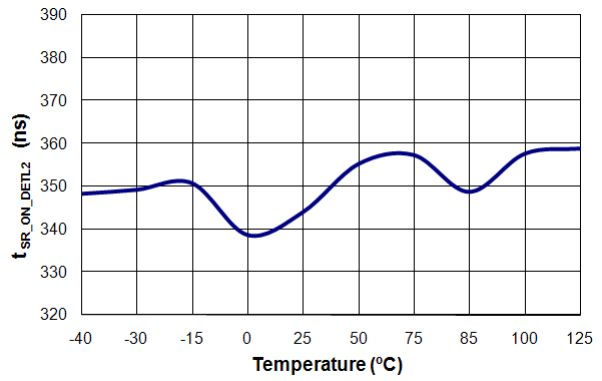

Figure 27. $t_{SR_ON_DET2}$ vs. T_A

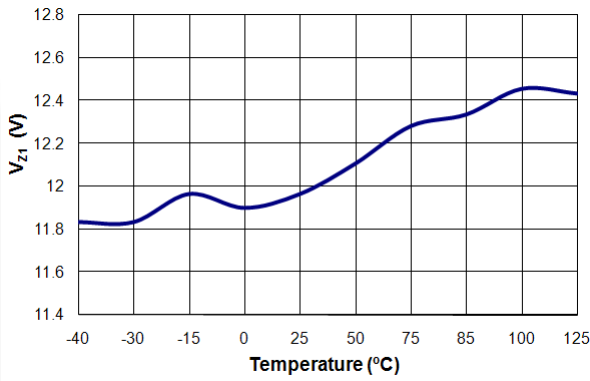

Figure 28. V_{Z1} vs. T_A

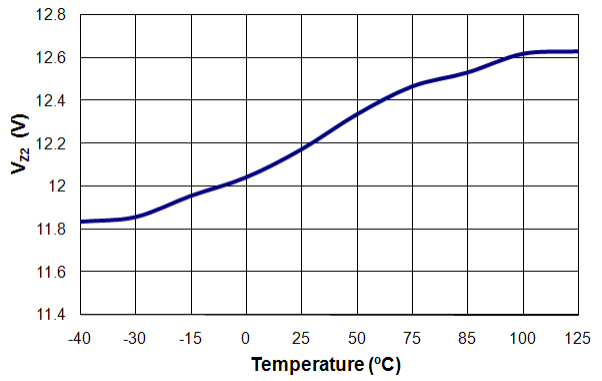

Figure 29. V_{Z2} vs. T_A

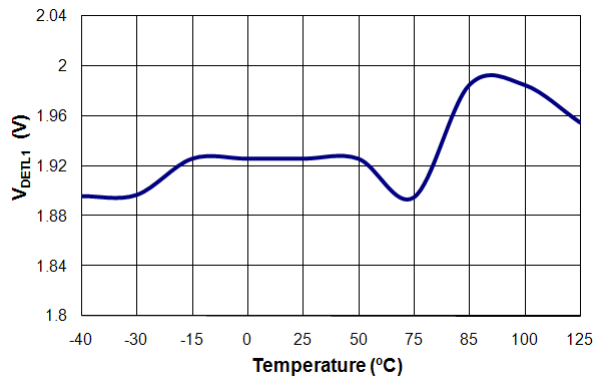

Figure 30. V_{DET1} vs. T_A

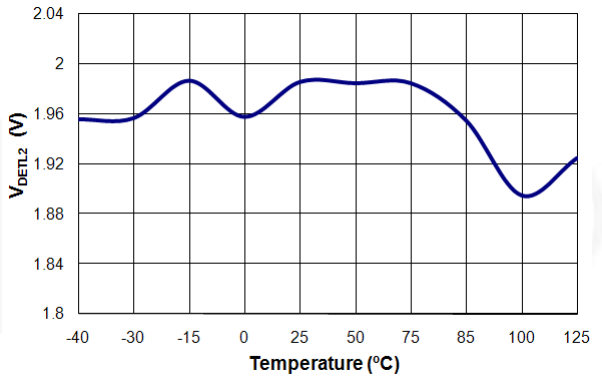

Figure 31. V_{DET2} vs. T_A

Typical Performance Characteristics (Continued)

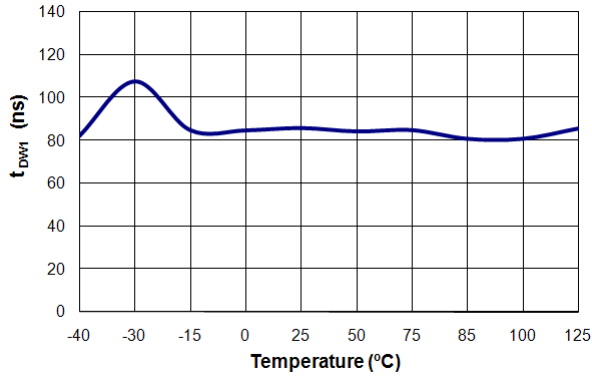

Figure 32. t_{DW1} vs. T_A

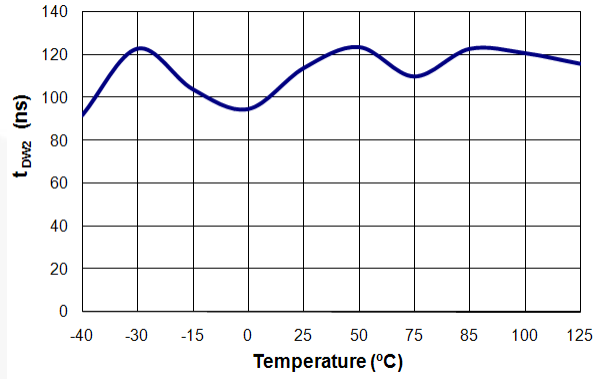

Figure 33. t_{DW2} vs. T_A

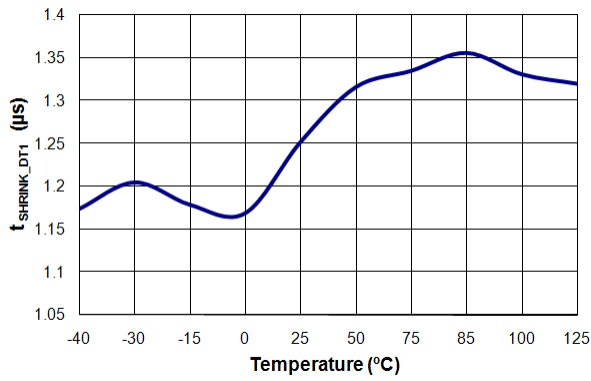

Figure 34. V_{SHRINK_DT1} vs. T_A

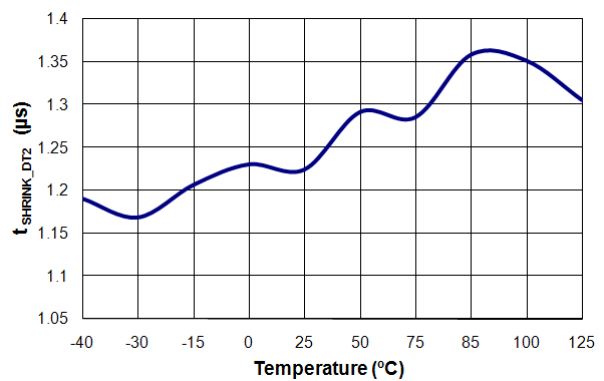

Figure 35. V_{SHRINK_DT2} vs. T_A

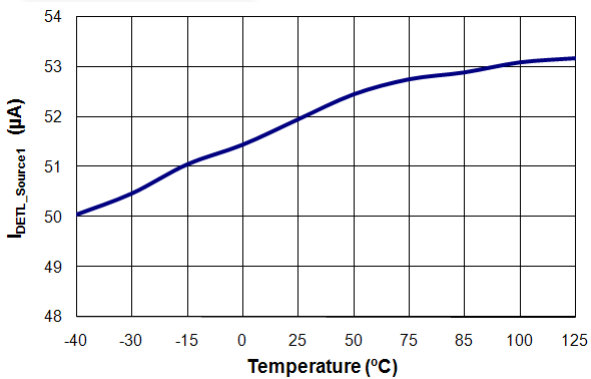

Figure 36. $I_{DET_Source1}$ vs. T_A

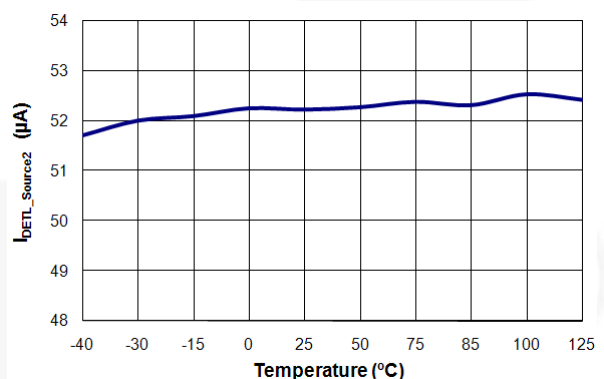

Figure 37. $I_{DET_Source2}$ vs. T_A

Typical Performance Characteristics (Continued)

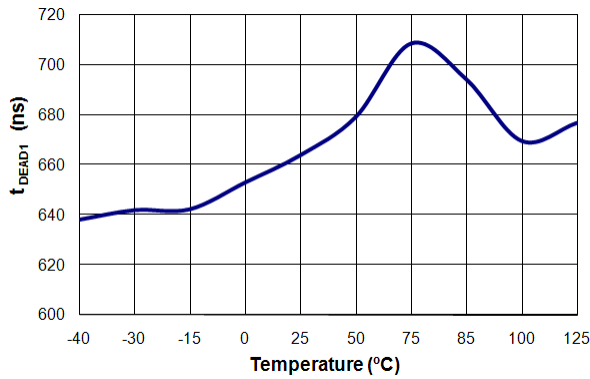

Figure 38. t_{DEAD1} ($R_{\text{RP}}=20 \text{ k}$, $6 \mu\text{s}$) vs. T_{A}

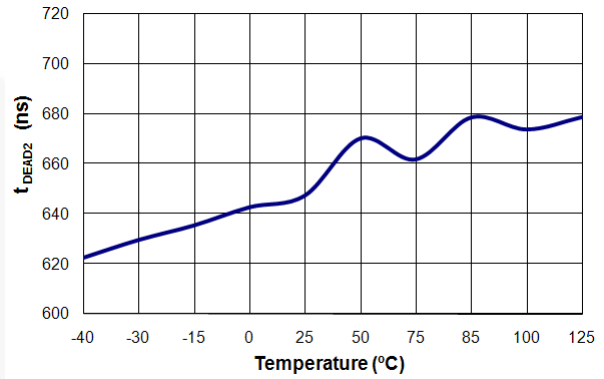

Figure 39. t_{DEAD2} ($R_{\text{RP}}=20 \text{ k}$, $6 \mu\text{s}$) vs. T_{A}

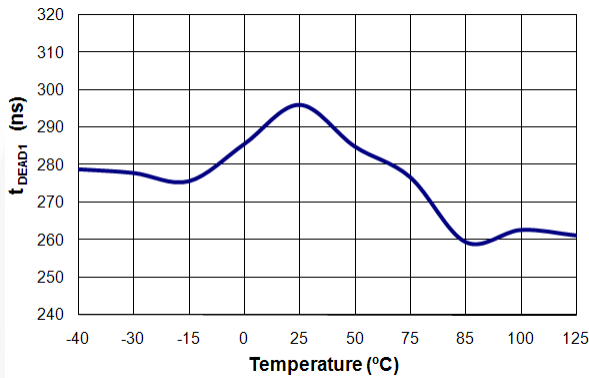

Figure 40. t_{DEAD1} ($R_{\text{RP}}=43 \text{ k}$, $2.5 \mu\text{s}$) vs. T_{A}

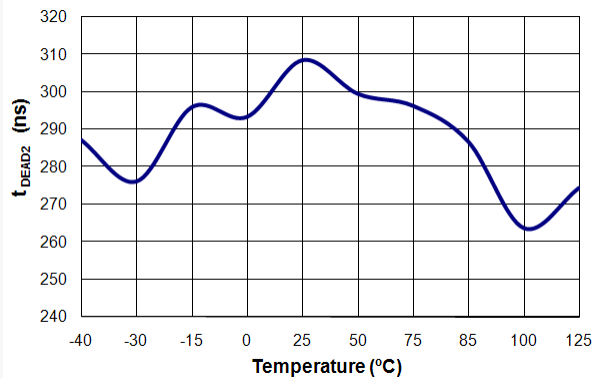

Figure 41. t_{DEAD2} ($R_{\text{RP}}=43 \text{ k}$, $2.5 \mu\text{s}$) vs. T_{A}

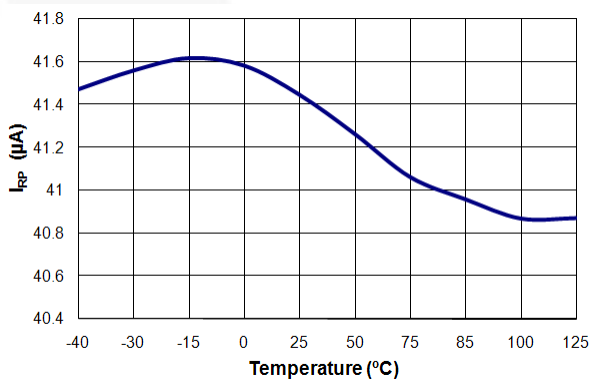

Figure 42. I_{RP} vs. T_{A}

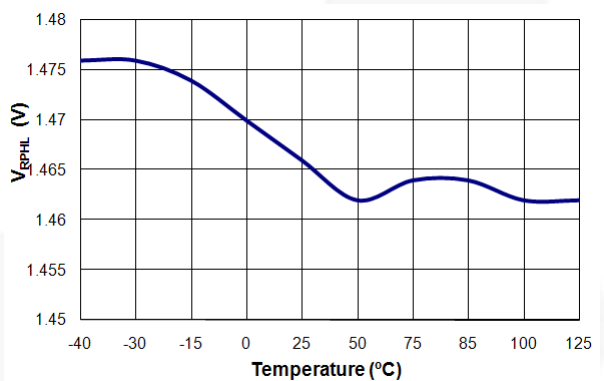

Figure 43. V_{RPHL} vs. T_{A}

Typical Application Circuit (LLC Converter with SR)

Application	Fairchild Devices	Input Voltage Range	Output
TV Power	FAN7621 FAN6208	350~400 V _{DC}	24 V / 8 A

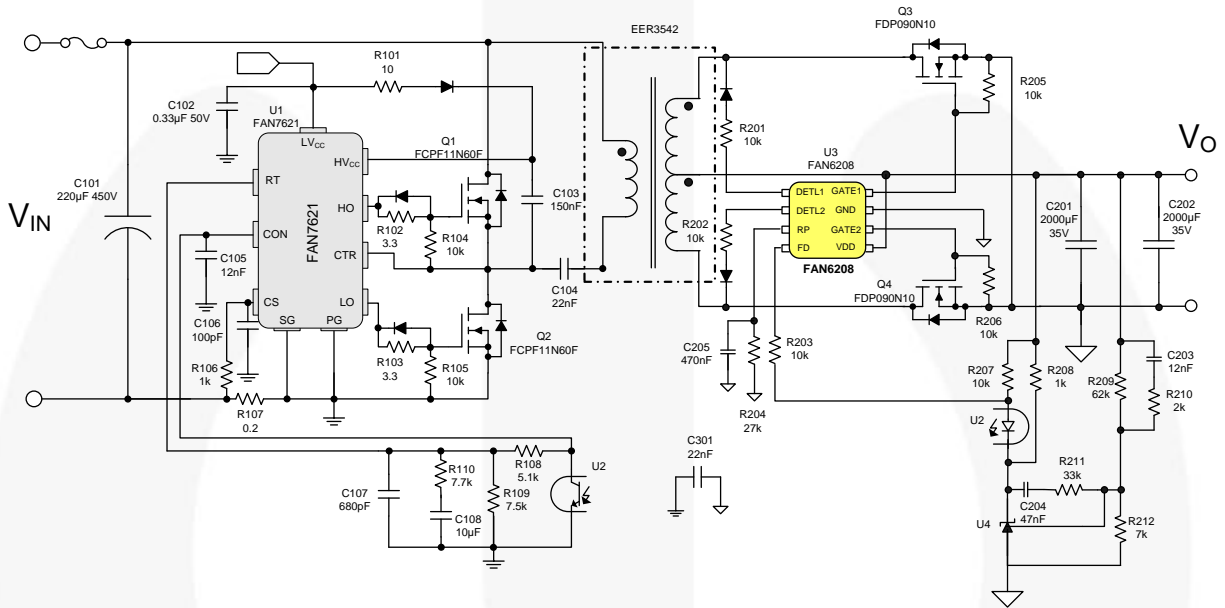
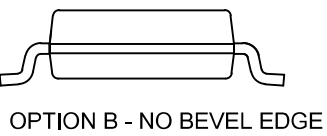
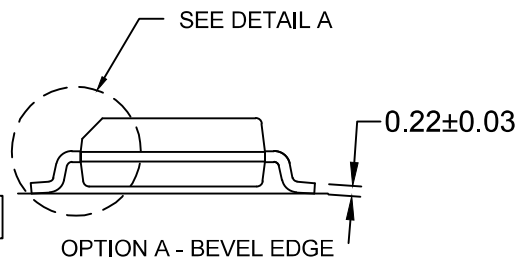
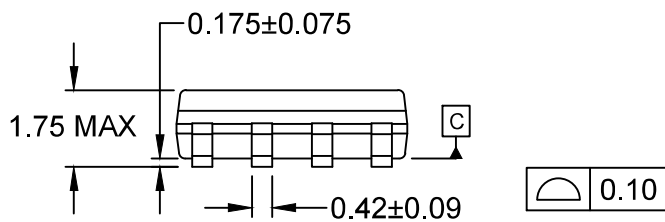

Figure 44. Application Circuit



NOTES:

- A) THIS PACKAGE CONFORMS TO JEDEC MS-012, VARIATION AA.
- B) ALL DIMENSIONS ARE IN MILLIMETERS.
- C) DIMENSIONS DO NOT INCLUDE MOLD FLASH OR BURRS.
- D) LANDPATTERN STANDARD: SOIC127P600X175-8M
- E) DRAWING FILENAME: M08Arev16





TRADEMARKS

The following includes registered and unregistered trademarks and service marks, owned by Fairchild Semiconductor and/or its global subsidiaries, and is not intended to be an exhaustive list of all such trademarks.

- | | | | |
|--------------------------|--|---------------------------------------|------------------|
| AccuPower™ | F-PFS™ | OPTOPLANAR® | SYSTEM GENERAL® |
| AttitudeEngine™ | FRFET® | Power Supply WebDesigner™ | TinyBoost® |
| Awinda® | Global Power Resource SM | PowerTrench® | TinyBuck® |
| AX-CAP®* | GreenBridge™ | PowerXS™ | TinyCalc™ |
| BitSiC™ | Green FPS™ | Programmable Active Droop™ | TinyLogic® |
| Build it Now™ | Green FPS™ e-Series™ | QFET® | TINYOPTO™ |
| CorePLUS™ | Gmax™ | QS™ | TinyPower™ |
| CorePOWER™ | GTO™ | Quiet Series™ | TinyPWM™ |
| CROSSVOL™ | IntelliMAX™ | RapidConfigure™ | TinyWire™ |
| CTL™ | ISOPLANAR™ | Saving our world, 1mW/W/kW at a time™ | TranSiC™ |
| Current Transfer Logic™ | Making Small Speakers Sound Louder and Better™ | SignalWise™ | TriFault Detect™ |
| DEUXPEED® | MegaBuck™ | SmartMax™ | TRUECURRENT®* |
| Dual Cool™ | MICROCOUPLER™ | SMART START™ | μSerDes™ |
| EcoSPARK® | MicroFET™ | Solutions for Your Success™ | UHC® |
| EfficientMax™ | MicroPak™ | SPM® | Ultra FRFET™ |
| ESBC™ | MicroPak2™ | STEALTH™ | UniFET™ |
| F [®] | MillerDrive™ | SuperFET® | VCX™ |
| Fairchild® | MotionMax™ | SuperSOT™-3 | VisualMax™ |
| Fairchild Semiconductor® | MotionGrid® | SuperSOT™-6 | VoltagePlus™ |
| FACT Quiet Series™ | MTi® | SuperSOT™-8 | XST™ |
| FACT® | MTx® | SupreMOS® | Xsens™ |
| FastvCore™ | MVN® | SyncFET™ | 仙童® |
| FETBench™ | mWSaver® | Sync-Lock™ | |
| FPS™ | OptoHiT™ | | |
| | OPTOLOGIC® | | |

* Trademarks of System General Corporation, used under license by Fairchild Semiconductor.

DISCLAIMER

FAIRCHILD SEMICONDUCTOR RESERVES THE RIGHT TO MAKE CHANGES WITHOUT FURTHER NOTICE TO ANY PRODUCTS HEREIN TO IMPROVE RELIABILITY, FUNCTION, OR DESIGN. TO OBTAIN THE LATEST, MOST UP-TO-DATE DATASHEET AND PRODUCT INFORMATION, VISIT OUR WEBSITE AT [HTTP://WWW.FAIRCHILDSEMI.COM](http://www.fairchildsemi.com). FAIRCHILD DOES NOT ASSUME ANY LIABILITY ARISING OUT OF THE APPLICATION OR USE OF ANY PRODUCT OR CIRCUIT DESCRIBED HEREIN; NEITHER DOES IT CONVEY ANY LICENSE UNDER ITS PATENT RIGHTS, NOR THE RIGHTS OF OTHERS. THESE SPECIFICATIONS DO NOT EXPAND THE TERMS OF FAIRCHILD'S WORLDWIDE TERMS AND CONDITIONS, SPECIFICALLY THE WARRANTY THEREIN, WHICH COVERS THESE PRODUCTS.

AUTHORIZED USE

Unless otherwise specified in this data sheet, this product is a standard commercial product and is not intended for use in applications that require extraordinary levels of quality and reliability. This product may not be used in the following applications, unless specifically approved in writing by a Fairchild officer: (1) automotive or other transportation, (2) military/aerospace, (3) any safety critical application – including life critical medical equipment – where the failure of the Fairchild product reasonably would be expected to result in personal injury, death or property damage. Customer's use of this product is subject to agreement of this Authorized Use policy. In the event of an unauthorized use of Fairchild's product, Fairchild accepts no liability in the event of product failure. In other respects, this product shall be subject to Fairchild's Worldwide Terms and Conditions of Sale, unless a separate agreement has been signed by both Parties.

ANTI-COUNTERFEITING POLICY

Fairchild Semiconductor Corporation's Anti-Counterfeiting Policy. Fairchild's Anti-Counterfeiting Policy is also stated on our external website, www.fairchildsemi.com, under Terms of Use

Counterfeiting of semiconductor parts is a growing problem in the industry. All manufacturers of semiconductor products are experiencing counterfeiting of their parts. Customers who inadvertently purchase counterfeit parts experience many problems such as loss of brand reputation, substandard performance, failed applications, and increased cost of production and manufacturing delays. Fairchild is taking strong measures to protect ourselves and our customers from the proliferation of counterfeit parts. Fairchild strongly encourages customers to purchase Fairchild parts either directly from Fairchild or from Authorized Fairchild Distributors who are listed by country on our web page cited above. Products customers buy either from Fairchild directly or from Authorized Fairchild Distributors are genuine parts, have full traceability, meet Fairchild's quality standards for handling and storage and provide access to Fairchild's full range of up-to-date technical and product information. Fairchild and our Authorized Distributors will stand behind all warranties and will appropriately address any warranty issues that may arise. Fairchild will not provide any warranty coverage or other assistance for parts bought from Unauthorized Sources. Fairchild is committed to combat this global problem and encourage our customers to do their part in stopping this practice by buying direct or from authorized distributors.

PRODUCT STATUS DEFINITIONS

Definition of Terms

Datasheet Identification	Product Status	Definition
Advance Information	Formative / In Design	Datasheet contains the design specifications for product development. Specifications may change in any manner without notice.
Preliminary	First Production	Datasheet contains preliminary data; supplementary data will be published at a later date. Fairchild Semiconductor reserves the right to make changes at any time without notice to improve design.
No Identification Needed	Full Production	Datasheet contains final specifications. Fairchild Semiconductor reserves the right to make changes at any time without notice to improve the design.
Obsolete	Not In Production	Datasheet contains specifications on a product that is discontinued by Fairchild Semiconductor. The datasheet is for reference information only.