

## FEATURES

### Integrated charge pump

Supply range: 3 V to 5.5 V

Output range:  $-3.3\text{ V}$  to  $-1.8\text{ V}$

50 mA maximum output current for external use at  $-3\text{ V}$

### High speed amplifiers

$-3\text{ dB}$  bandwidth: 600 MHz

Slew rate: 600 V/ $\mu\text{s}$

0.1 dB flatness: 85 MHz

0.1% settling time: 18 ns

### Low power

Total quiescent current: 42 mA

Power-down feature

### High input common-mode voltage range

$-1.8\text{ V}$  to  $+3.8\text{ V}$  at +5 V supply

### Current feedback architecture

Differential gain error: 0.01%

Differential phase error: 0.02°

Available in 16-lead LFCSP

## APPLICATIONS

Professional video

Consumer video

Imaging

Active filters

## GENERAL DESCRIPTION

The ADA4858-3 (triple) is a single-supply, high speed current feedback amplifier with an integrated charge pump that eliminates the need for negative supplies to output negative voltages or output a 0 V level for video applications. The 600 MHz,  $-3\text{ dB}$  bandwidth and 600 V/ $\mu\text{s}$  slew rate make this amplifier well suited for many high speed applications. In addition, its 0.1 dB flatness out to 85 MHz at  $G = 2$ , along with its differential gain and phase errors of 0.01% and 0.02° into a 150  $\Omega$  load, make it well suited for professional and consumer video applications.

This triple operational amplifier is designed to operate on supply voltages of 3.3 V to 5 V, using only 42 mA of total quiescent current, including the charge pump. To further reduce the power consumption, it is equipped with a power-down feature that lowers the total supply current to as low as 2.5 mA when the amplifier is not being used. Even in power-down mode, the charge pump can be used to power external components. The maximum output current for external use is 50 mA at  $-3\text{ V}$ . The amplifier also has a wide input common-mode voltage range that extends from 1.8 V below ground to 1.2 V below the positive rail at a 5 V supply.

The ADA4858-3 is available in a 16-lead LFCSP, and it is designed to work over the extended industrial temperature range of  $-40^\circ\text{C}$  to  $+105^\circ\text{C}$ .

## CONNECTION DIAGRAM

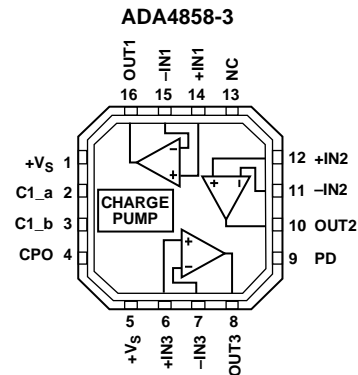

NOTES  
1. NC = NO CONNECT.  
2. EXPOSED PAD, CONNECT TO GROUND.

Figure 1.

07714-001

Rev. B

[Document Feedback](#)

Information furnished by Analog Devices is believed to be accurate and reliable. However, no responsibility is assumed by Analog Devices for its use, nor for any infringements of patents or other rights of third parties that may result from its use. Specifications subject to change without notice. No license is granted by implication or otherwise under any patent or patent rights of Analog Devices. Trademarks and registered trademarks are the property of their respective owners.

# ADA4858-3\* Product Page Quick Links

Last Content Update: 08/30/2016

---

## [Comparable Parts](#)

View a parametric search of comparable parts

## [Evaluation Kits](#)

- ADA4858-3 Evaluation Board

## [Documentation](#)

### **Data Sheet**

- ADA4858-3: Single-Supply, High Speed, Triple Op Amp with Charge Pump Data Sheet

### **User Guides**

- UG-140: Universal Evaluation Board for Triple, High Speed Op Amps with Charge Pump Offered in 16-Lead, 4 mm × 4 mm LFCSP Packages

## [Tools and Simulations](#)

- ADA4858 SPICE Macro Model

## [Reference Materials](#)

### **Tutorials**

- MT-034: Current Feedback (CFB) Op Amps
- MT-051: Current Feedback Op Amp Noise Considerations
- MT-057: High Speed Current Feedback Op Amps
- MT-059: Compensating for the Effects of Input Capacitance on VFB and CFB Op Amps Used in Current-to-Voltage Converters

## [Design Resources](#)

- ADA4858-3 Material Declaration
- PCN-PDN Information
- Quality And Reliability
- Symbols and Footprints

## [Discussions](#)

View all ADA4858-3 EngineerZone Discussions

## [Sample and Buy](#)

Visit the product page to see pricing options

## [Technical Support](#)

Submit a technical question or find your regional support number

**TABLE OF CONTENTS**

Features .....	1	Applications Information .....	14
Applications.....	1	Gain Configurations .....	14
Connection Diagram .....	1	DC-Coupled Video Signal .....	14
General Description .....	1	Multiple Video Driver.....	14
Revision History .....	2	DC Restore Function .....	15
Specifications.....	3	Clamp Amplifier.....	15
Absolute Maximum Ratings.....	5	PD (Power-Down) Pin .....	16
Maximum Power Dissipation .....	5	Power Supply Bypassing .....	16
ESD Caution.....	5	Layout .....	16
Pin Configuration and Function Descriptions.....	6	Outline Dimensions .....	17
Typical Performance Characteristics .....	7	Ordering Guide .....	17
Theory of Operation .....	13		
Overview.....	13		
Charge Pump Operation .....	13		

**REVISION HISTORY**

**11/12—Rev. A to Rev. B**

Changes to PD (Power-Down) Pin Section ..... 16

**5/09—Rev. 0 to Rev. A**

Changes to Overview Section and Charge Pump Operation  
Section..... 13  
 Changes to Table 5 and Figure 41..... 14  
 Added DC Restore Function Section, Figure 43, Clamp  
 Amplifier Section, and Figure 44..... 15

**10/08—Revision 0: Initial Version**

## SPECIFICATIONS

$T_A = 25^\circ\text{C}$ ,  $V_S = 5\text{ V}$ ,  $G = 2$ ,  $R_F = 301\ \Omega$ ,  $R_F = 402\ \Omega$  for  $G = 1$ ,  $R_L = 150\ \Omega$ , unless otherwise noted.

Table 1.

Parameter	Conditions	Min	Typ	Max	Unit	
<b>DYNAMIC PERFORMANCE</b>						
–3 dB Bandwidth	$V_{OUT} = 0.1\text{ V p-p}$ , $G = 1$		600		MHz	
	$V_{OUT} = 0.1\text{ V p-p}$		350		MHz	
	$V_{OUT} = 2\text{ V p-p}$ , $G = 1$		165		MHz	
	$V_{OUT} = 2\text{ V p-p}$		175		MHz	
	Bandwidth for 0.1 dB Flatness	$V_{OUT} = 2\text{ V p-p}$		85		MHz
	Slew Rate	$V_{OUT} = 2\text{ V step}$		600		V/ $\mu\text{s}$
Settling Time to 0.1%	$V_{OUT} = 2\text{ V step}$		18		ns	
<b>NOISE/DISTORTION PERFORMANCE</b>						
Harmonic Distortion (HD2/HD3)	$f_C = 1\text{ MHz}$ , $V_{OUT} = 2\text{ V p-p}$		–86/–94		dBc	
	$f_C = 5\text{ MHz}$ , $V_{OUT} = 2\text{ V p-p}$		–71/–84		dBc	
Crosstalk	$f = 5\text{ MHz}$		–60		dB	
Input Voltage Noise	$f = 1\text{ MHz}$		4		nV/ $\sqrt{\text{Hz}}$	
Input Current Noise	$f = 1\text{ MHz (+IN/-IN)}$		2/9		pA/ $\sqrt{\text{Hz}}$	
Differential Gain Error			0.01		%	
Differential Phase Error			0.02		Degrees	
<b>DC PERFORMANCE</b>						
Input Offset Voltage		–14	+0.5	+14	mV	
+ Input Bias Current		–2	+0.7	+2	$\mu\text{A}$	
– Input Bias Current		–13	+8	+13	$\mu\text{A}$	
Open-Loop Transimpedance		300	390		k $\Omega$	
<b>INPUT CHARACTERISTICS</b>						
Input Resistance	+IN1/+IN2		15		M $\Omega$	
	–IN1/–IN2		90		$\Omega$	
Input Capacitance	+IN1/+IN2		1.5		pF	
Input Common-Mode Voltage Range	Typical	–1.8		+3.8	V	
Common-Mode Rejection Ratio			–61	–54	dB	
<b>OUTPUT CHARACTERISTICS</b>						
Output Voltage Swing		–1.4 to +3.6	–1.7 to +3.7		V	
Output Overdrive Recovery Time	Rise/fall, $f = 5\text{ MHz}$		15		ns	
Maximum Linear Output Current @ $V_{OUT} = 1\text{ V}_{PEAK}$	$f_C = 1\text{ MHz}$ , $\text{HD}_2 \leq -50\text{ dBc}$		21		mA	
<b>POWER-DOWN</b>						
Input Voltage	Enabled		1.9		V	
	Powered down		2		V	
Bias Current		–0.1		+0.1	$\mu\text{A}$	
Turn-On Time			0.3		$\mu\text{s}$	
Turn-Off Time			1.6		$\mu\text{s}$	
<b>POWER SUPPLY</b>						
Operating Range		3		5.5	V	
Total Quiescent Current	Amplifiers	15	19	21	mA	
	Charge Pump		23		mA	
Total Quiescent Current When Powered Down	Amplifiers	0.15	0.25	0.3	mA	
	Charge Pump		4		mA	
Positive Power Supply Rejection Ratio			–64	–60	dB	
Negative Power Supply Rejection Ratio			–58	–54	dB	
Charge Pump Output Voltage		–3.3	–3	–2.5	V	
Charge Pump Sink Current				150	mA	

T<sub>A</sub> = 25°C, V<sub>S</sub> = 3.3 V, G = 2, R<sub>F</sub> = 301 Ω, R<sub>F</sub> = 402 Ω for G = 1, R<sub>L</sub> = 150 Ω, unless otherwise noted.

Table 2.

Parameter	Conditions	Min	Typ	Max	Unit
<b>DYNAMIC PERFORMANCE</b>					
-3 dB Bandwidth	V <sub>OUT</sub> = 0.1 V p-p, G = 1		540		MHz
	V <sub>OUT</sub> = 0.1 V p-p		340		MHz
	V <sub>OUT</sub> = 2 V p-p, G = 1		140		MHz
	V <sub>OUT</sub> = 2 V p-p		145		MHz
Bandwidth for 0.1 dB Flatness	V <sub>OUT</sub> = 2 V p-p		70		MHz
Slew Rate	V <sub>OUT</sub> = 2 V step		430		V/μs
Settling Time to 0.1%	V <sub>OUT</sub> = 2 V step		20		ns
<b>NOISE/DISTORTION PERFORMANCE</b>					
Harmonic Distortion (HD2/HD3)	f <sub>C</sub> = 1 MHz, V <sub>OUT</sub> = 2 V p-p		-88/-91		dBc
	f <sub>C</sub> = 5 MHz, V <sub>OUT</sub> = 2 V p-p		-75/-78		dBc
Crosstalk	f = 5 MHz		-60		dB
Input Voltage Noise	f = 1 MHz		4		nV/√Hz
Input Current Noise	f = 1 MHz (+IN/-IN)		2/9		pA/√Hz
Differential Gain Error			0.02		%
Differential Phase Error			0.03		Degrees
<b>DC PERFORMANCE</b>					
Input Offset Voltage		-14	+0.7	+14	mV
+ Input Bias Current		-2	+0.6	+2	μA
- Input Bias Current		-13	+7	+13	μA
Open-Loop Transimpedance		300	350		kΩ
<b>INPUT CHARACTERISTICS</b>					
Input Resistance	+IN1/+IN2		15		MΩ
	-IN1/-IN2		90		Ω
Input Capacitance	+IN1/+IN2		1.5		pF
Input Common-Mode Voltage Range	Typical	-0.9		+2.2	V
Common-Mode Rejection Ratio			-60	-54	dB
<b>OUTPUT CHARACTERISTICS</b>					
Output Voltage Swing		-0.6 to +2.1	-0.9 to +2.2		V
Output Overdrive Recovery Time	Rise/fall, f = 5 MHz		15		ns
Maximum Linear Output Current @ V <sub>OUT</sub> = 1 V <sub>PEAK</sub>	f <sub>C</sub> = 1 MHz, HD2 ≤ -50 dBc		20		mA
<b>POWER-DOWN</b>					
Input Voltage	Enabled		1.25		V
	Powered down		1.35		V
Bias Current		-0.1		+0.1	μA
Turn-On Time			0.3		μs
Turn-Off Time			1.6		μs
<b>POWER SUPPLY</b>					
Operating Range		3		5.5	V
Total Quiescent Current	Amplifiers	14	19	20	mA
	Charge Pump		21		mA
Total Quiescent Current When Powered Down	Amplifiers	0.15	0.25	0.3	mA
	Charge Pump		2		mA
Positive Power Supply Rejection Ratio			-63	-60	dB
Negative Power Supply Rejection Ratio			-57	-54	dB
Charge Pump Output Voltage		-2.1	-2	-1.8	V
Charge Pump Sink Current				45	mA

## ABSOLUTE MAXIMUM RATINGS

Table 3.

Parameter	Rating
Supply Voltage	6 V
Internal Power Dissipation <sup>1</sup> 16-Lead LFCSP	See Figure 2
Input Voltage (Common Mode)	( $-V_S - 0.2V$ ) to ( $+V_S - 1.2V$ )
Differential Input Voltage	$\pm V_S$
Output Short-Circuit Duration	Observe power derating curves
Storage Temperature Range	$-65^{\circ}\text{C}$ to $+125^{\circ}\text{C}$
Operating Temperature Range	$-40^{\circ}\text{C}$ to $+105^{\circ}\text{C}$
Lead Temperature (Soldering, 10 sec)	$300^{\circ}\text{C}$

<sup>1</sup> Specification is for device in free air.

Stresses above those listed under Absolute Maximum Ratings may cause permanent damage to the device. This is a stress rating only; functional operation of the device at these or any other conditions above those indicated in the operational section of this specification is not implied. Exposure to absolute maximum rating conditions for extended periods may affect device reliability.

## MAXIMUM POWER DISSIPATION

The maximum power that can be safely dissipated by the ADA4858-3 is limited by the associated rise in junction temperature. The maximum safe junction temperature for plastic encapsulated devices is determined by the glass transition temperature of the plastic, approximately  $150^{\circ}\text{C}$ . Temporarily exceeding this limit may cause a shift in parametric performance due to a change in the stresses exerted on the die by the package. Exceeding a junction temperature of  $175^{\circ}\text{C}$  for an extended period can result in device failure.

To ensure proper operation, it is necessary to observe the maximum power derating curves in Figure 2.

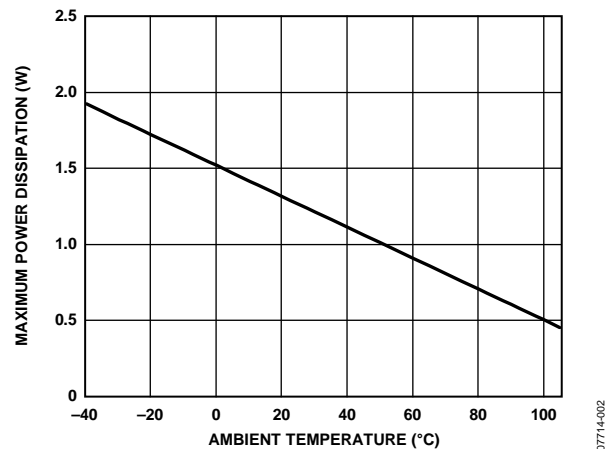

Figure 2. Maximum Power Dissipation vs. Ambient Temperature

## ESD CAUTION



**ESD (electrostatic discharge) sensitive device.** Charged devices and circuit boards can discharge without detection. Although this product features patented or proprietary protection circuitry, damage may occur on devices subjected to high energy ESD. Therefore, proper ESD precautions should be taken to avoid performance degradation or loss of functionality.

## PIN CONFIGURATION AND FUNCTION DESCRIPTIONS

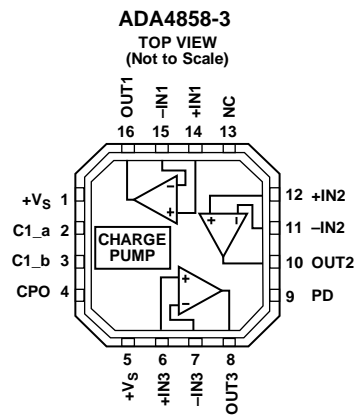

NOTES  
 1. NC = NO CONNECT.  
 2. EXPOSED PAD, CONNECT TO GROUND.

07714-003

Figure 3. Pin Configuration.

Table 4. Pin Function Descriptions

Pin No.	Mnemonic	Description
1	+V <sub>S</sub>	Positive Supply for Charge Pump.
2	C1_a	Charge Pump Capacitor Side a.
3	C1_b	Charge Pump Capacitor Side b.
4	CPO	Charge Pump Output.
5	+V <sub>S</sub>	Positive Supply.
6	+IN3	Noninverting Input 3.
7	-IN3	Inverting Input 3.
8	OUT3	Output 3.
9	PD	Power-Down.
10	OUT2	Output 2.
11	-IN2	Inverting Input 2.
12	+IN2	Noninverting Input 2.
13	NC	No Connect.
14	+IN1	Noninverting Input 1.
15	-IN1	Inverting Input 1.
16	OUT1	Output 1.
EPAD	Exposed Pad (EPAD)	The exposed pad must be connected to ground.

# TYPICAL PERFORMANCE CHARACTERISTICS

$T_A = 25^\circ\text{C}$ ,  $V_S = 5\text{ V}$ ,  $G = 2$ ,  $R_F = 301\ \Omega$ ,  $R_F = 402\ \Omega$  for  $G = 1$ ,  $R_F = 200\ \Omega$  for  $G = 5$ ,  $R_L = 150\ \Omega$ , large signal  $V_{\text{OUT}} = 2\text{ V p-p}$ , and small signal  $V_{\text{OUT}} = 0.1\text{ V p-p}$ , unless otherwise noted.

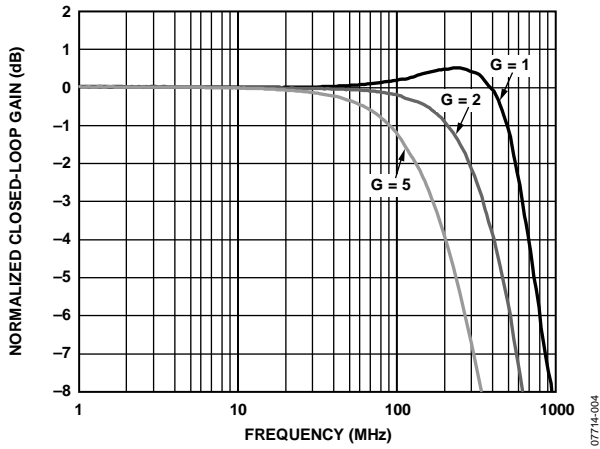

Figure 4. Small Signal Frequency Response vs. Gain

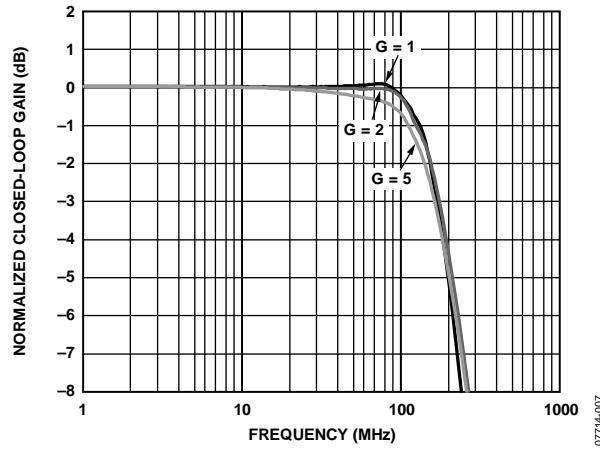

Figure 7. Large Signal Frequency Response vs. Gain

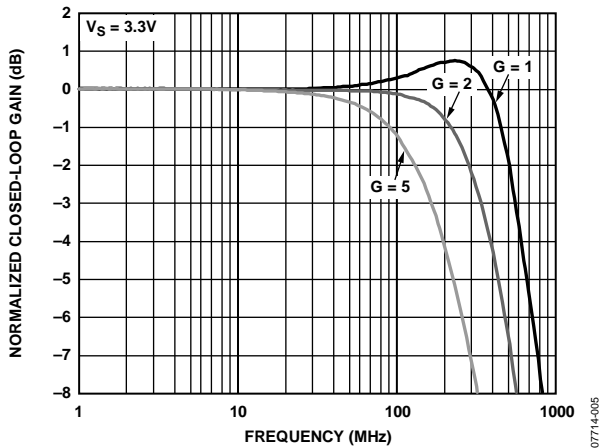

Figure 5. Small Signal Frequency Response vs. Gain

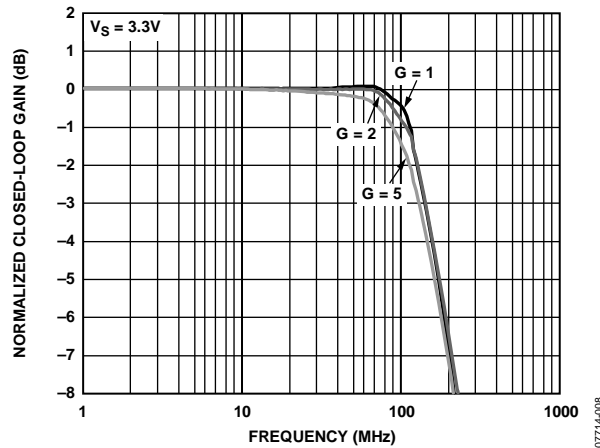

Figure 8. Large Signal Frequency Response vs. Gain

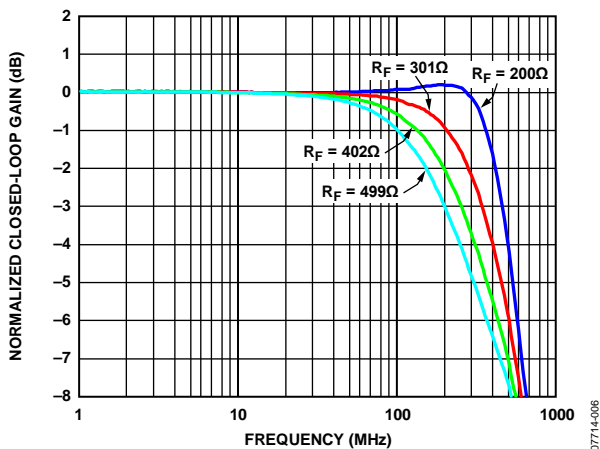

Figure 6. Small Signal Frequency Response vs. Feedback Resistor

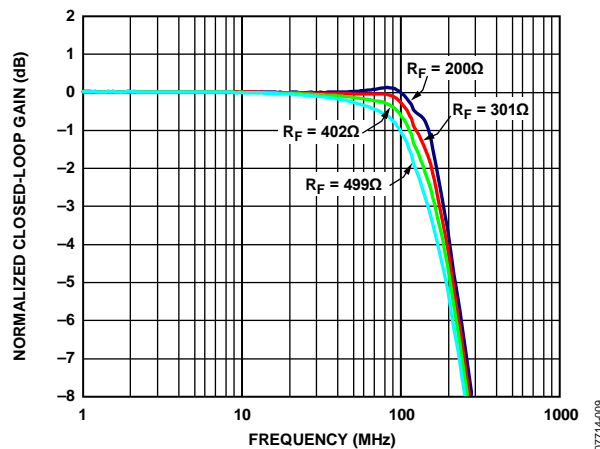

Figure 9. Large Signal Frequency Response vs. Feedback Resistor



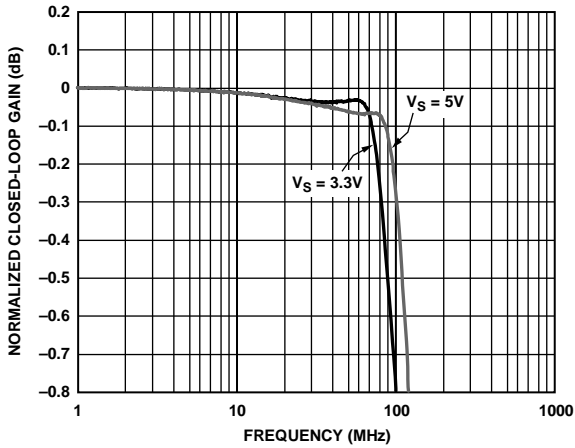

Figure 10. Large Signal 0.1 dB Flatness vs. Supply Voltage

07714-010

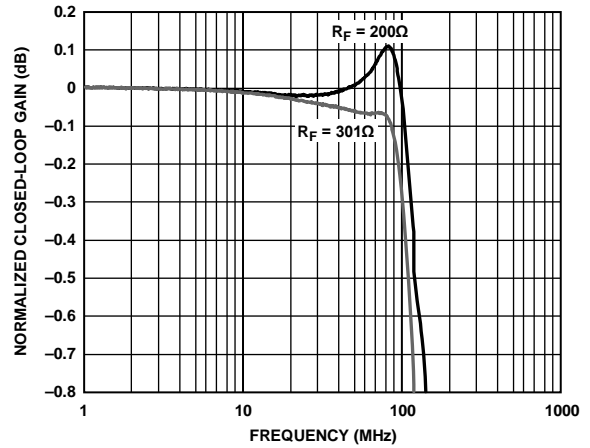

Figure 13. Large Signal 0.1 dB Flatness vs. Feedback Resistor

07714-013

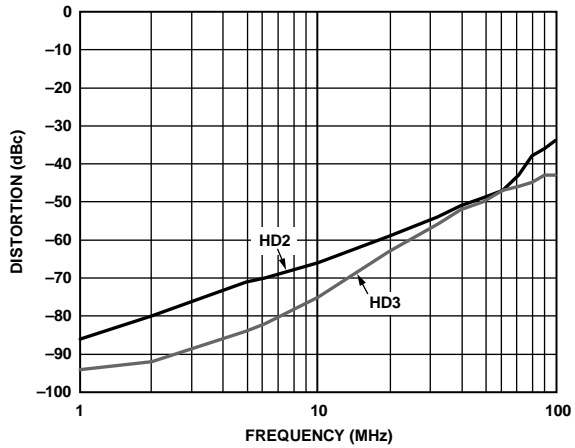

Figure 11. Harmonic Distortion vs. Frequency

07714-011

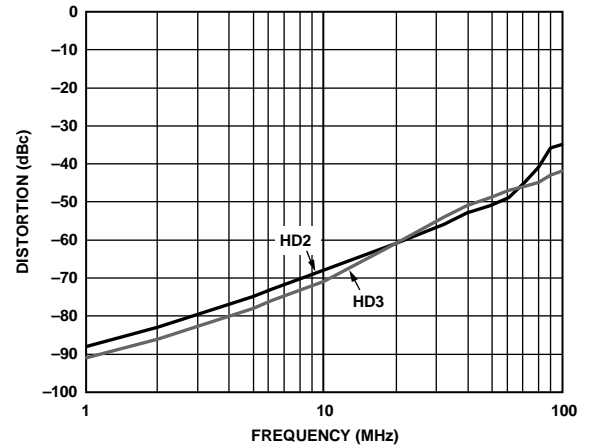

Figure 14. Harmonic Distortion vs. Frequency,  $V_S = 3.3\text{ V}$

07714-014

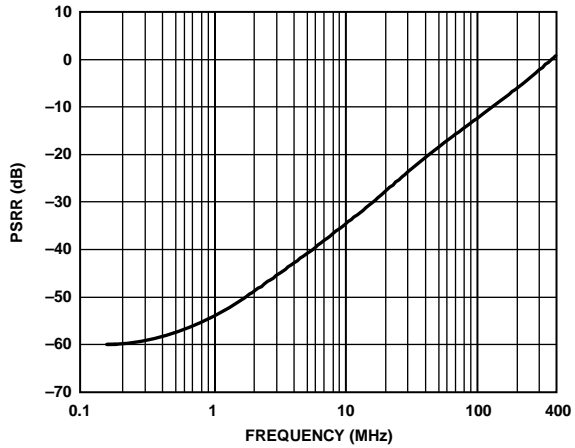

Figure 12. Power Supply Rejection Ratio (PSRR) vs. Frequency

07714-012

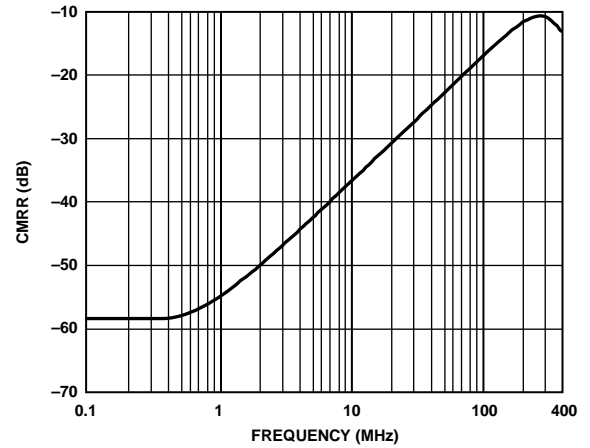

Figure 15. Common-Mode Rejection Ratio (CMRR) vs. Frequency

07714-015

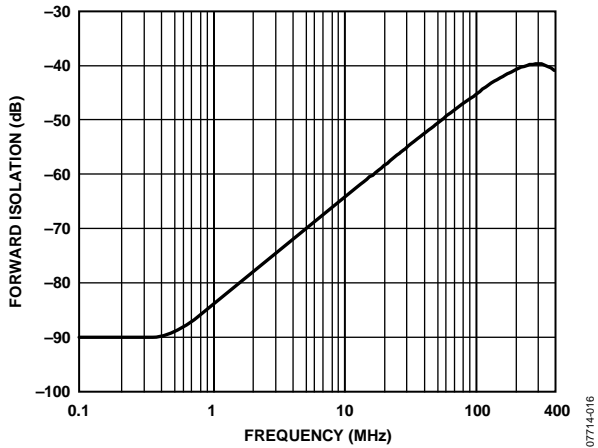

Figure 16. Forward Isolation vs. Frequency

07714-016

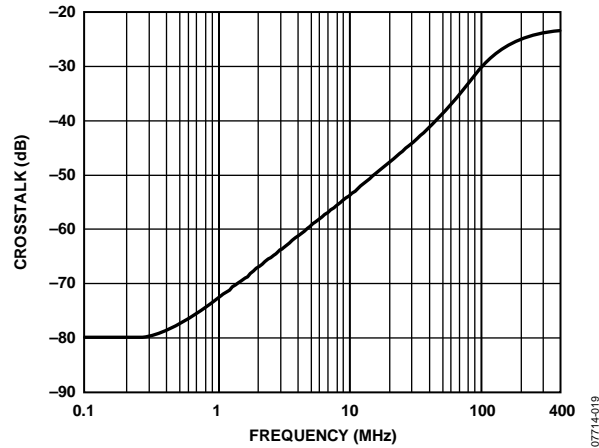

Figure 19. Crosstalk vs. Frequency

07714-019

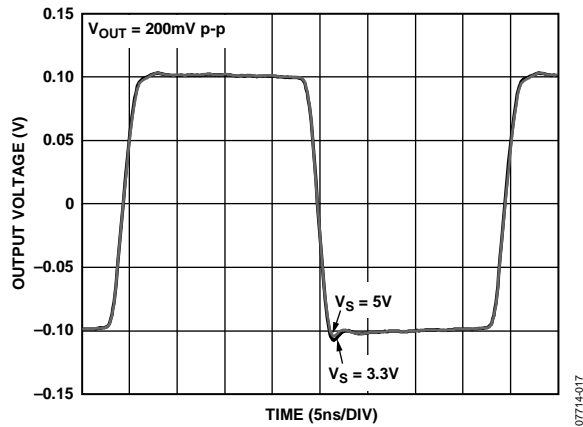

Figure 17. Small Signal Transient Response vs. Supply Voltage

07714-017

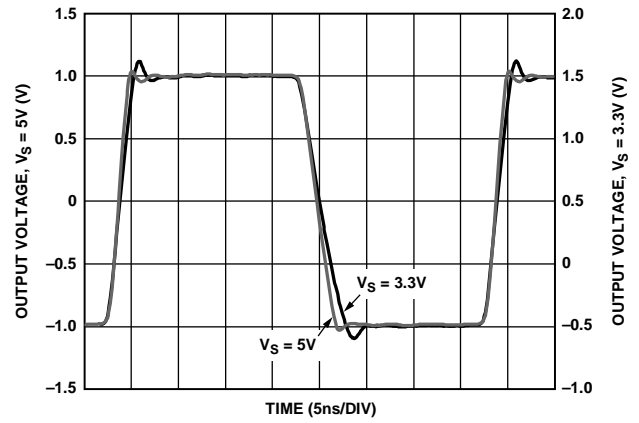

Figure 20. Large Signal Transient Response vs. Supply Voltage

07714-020

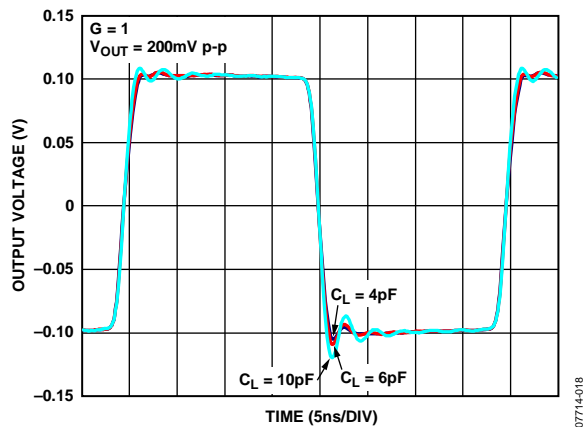

Figure 18. Small Signal Transient Response vs. Capacitive Load

07714-018

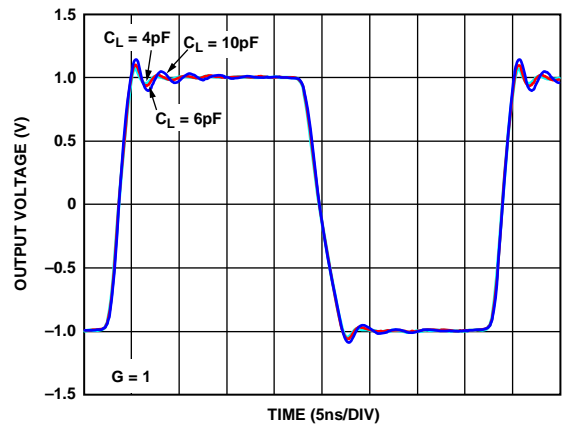

Figure 21. Large Signal Transient Response vs. Capacitive Load

07714-021

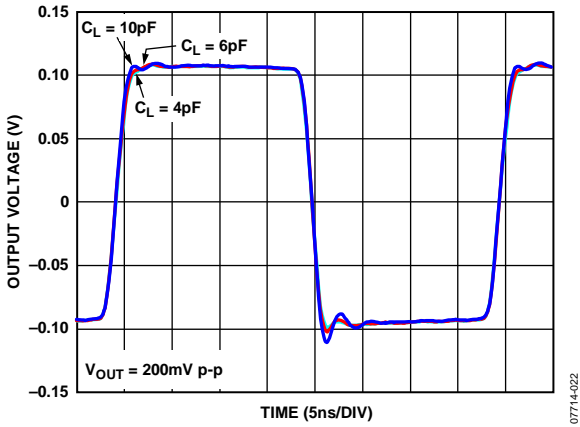

Figure 22. Small Signal Transient Response vs. Capacitive Load

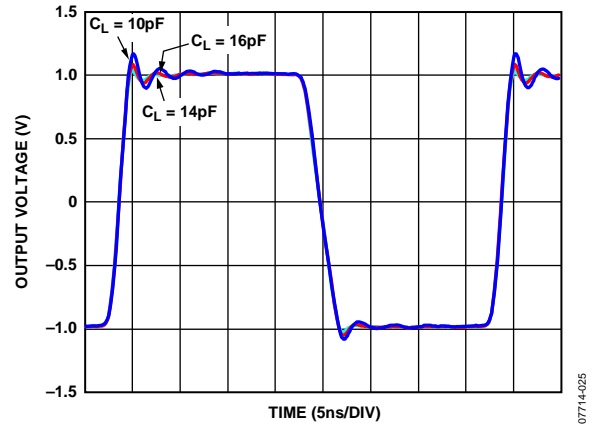

Figure 25. Large Signal Transient Response vs. Capacitive Load

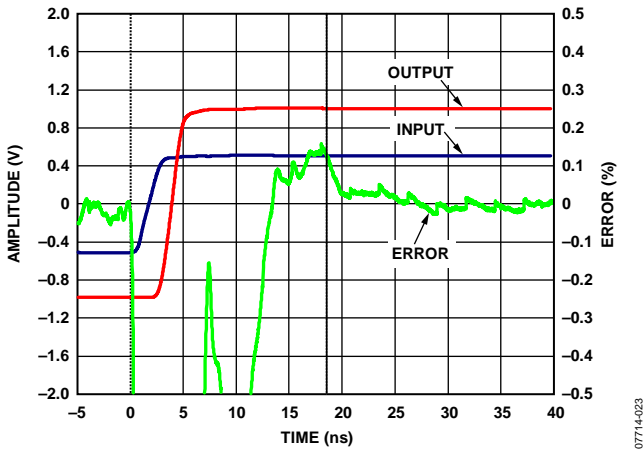

Figure 23. Settling Time (Rise)

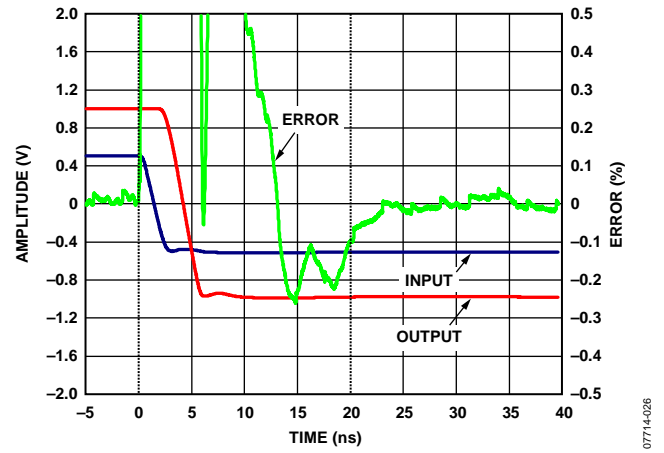

Figure 26. Settling Time (Fall)

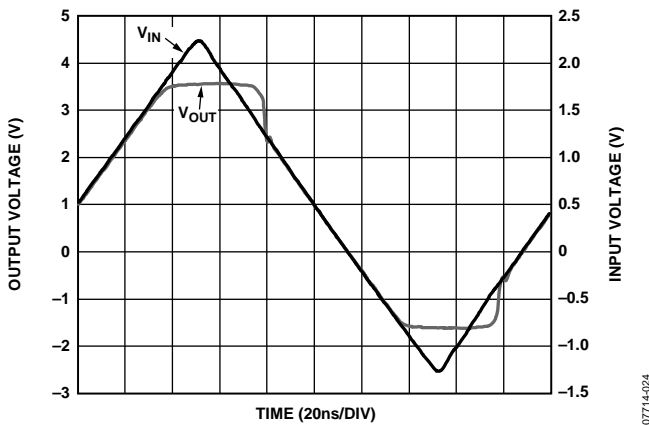

Figure 24. Output Overdrive Recovery

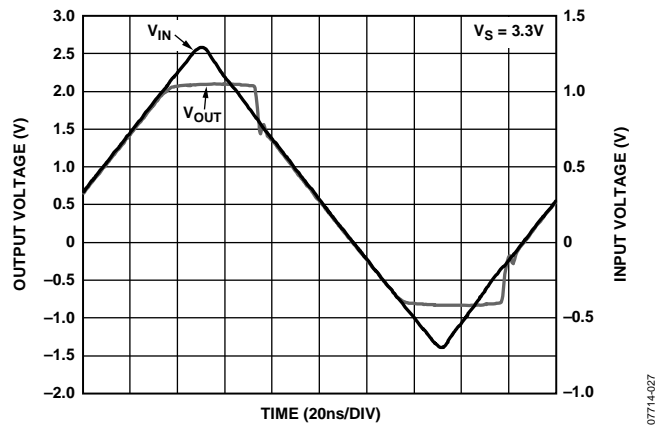

Figure 27. Output Overdrive Recovery,  $V_S = 3.3V$

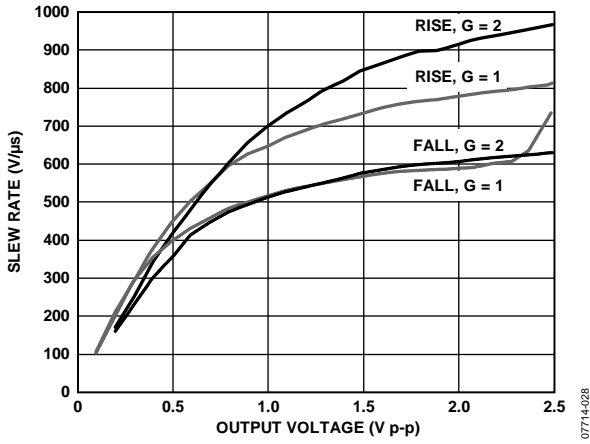

Figure 28. Slew Rate vs. Output Voltage

07714-028

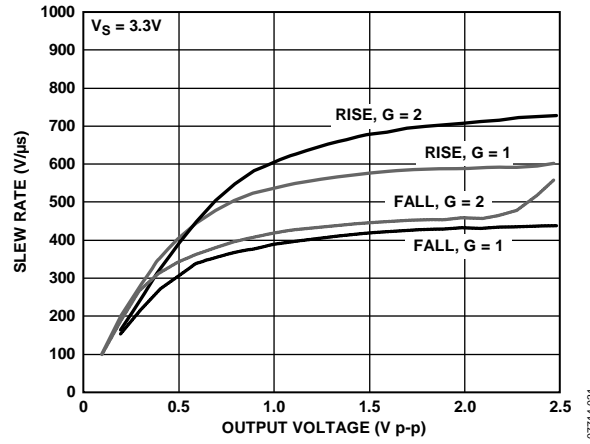

Figure 31. Slew Rate vs. Output Voltage,  $V_S = 3.3V$

07714-031

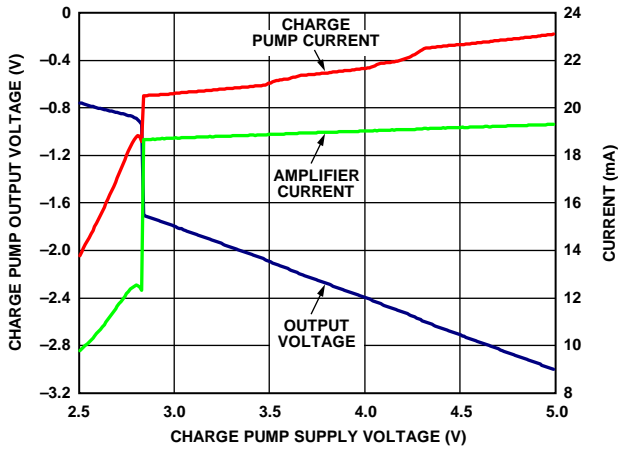

Figure 29. Charge Pump Output Voltage and Current vs. Charge Pump Supply Voltage

07714-029

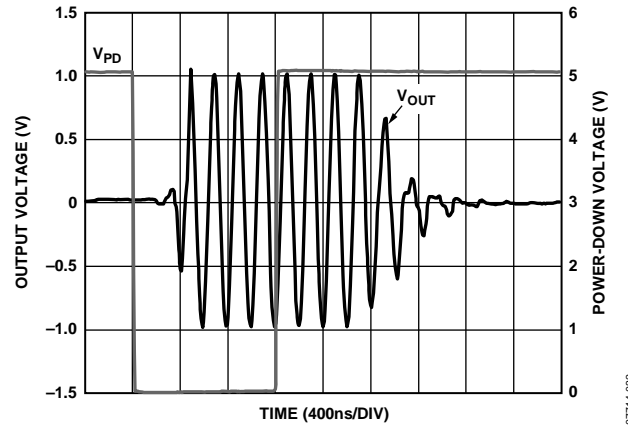

Figure 32. Enable/Power-Down Time

07714-032

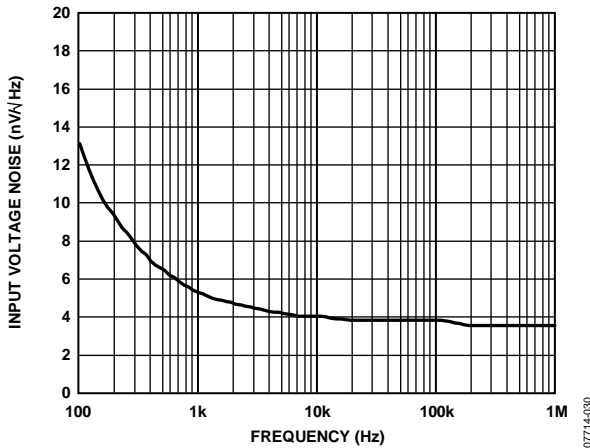

Figure 30. Input Voltage Noise vs. Frequency

07714-030

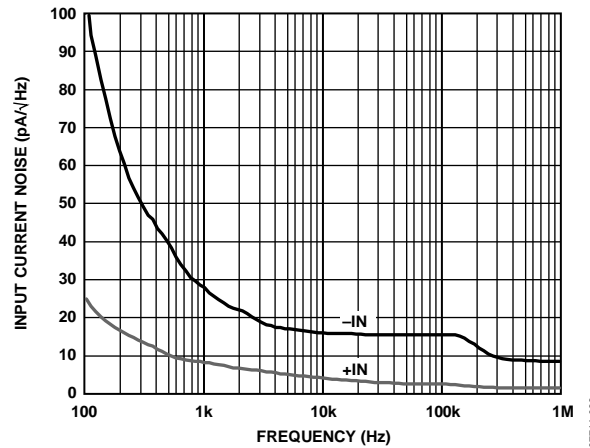

Figure 33. Input Current Noise vs. Frequency

07714-033

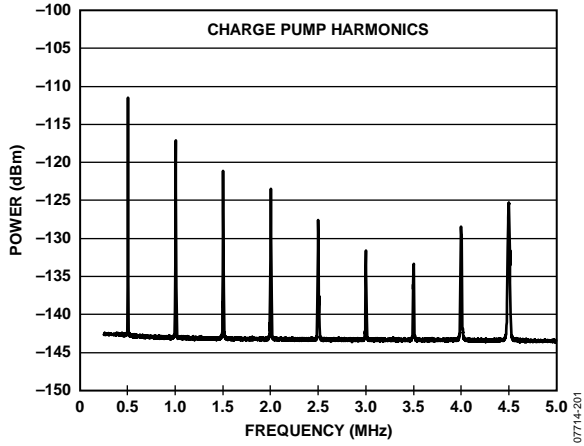

Figure 34. Output Spectrum vs. Frequency

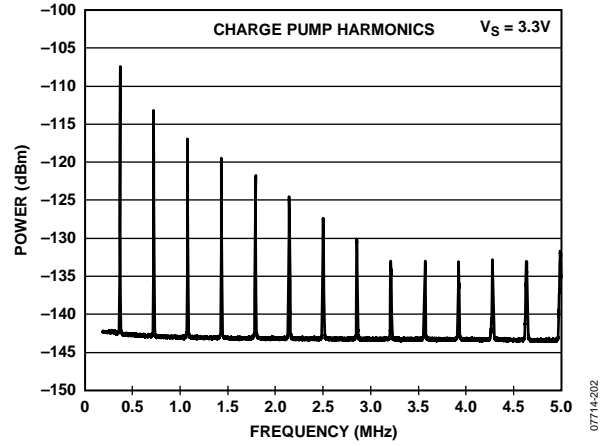

Figure 35. Output Spectrum vs. Frequency,  $V_S = 3.3 V$

## THEORY OF OPERATION

### OVERVIEW

The ADA4858-3 is a current feedback amplifier designed for exceptional performance as a triple amplifier with a variable gain capability. Its specifications make it especially suitable for SD and HD video applications. The ADA4858-3 provides HD video output on a single supply as low as 3.0 V while only consuming 13 mA per amplifier. It also features a power-down pin (PD) that reduces the total quiescent current to 2 mA when activated.

The ADA4858-3 can be used in applications that require both ac- and dc-coupled inputs and outputs. The output stage on the ADA4858-3 is capable of driving 2 V p-p video signals into two doubly terminated video loads (150  $\Omega$  each) on a single 5 V supply. The input range of the ADA4858-3 includes ground, and the output range is limited by the output headroom set by the voltage drop across the two diodes from each rail, which occurs 1.2 V from the positive supply and the charge pump negative supply rails.

### CHARGE PUMP OPERATION

The on-board charge pump creates a negative supply for the amplifier. It provides different negative voltages depending on the power supply voltage. For a +5 V supply, the negative supply generated is equal to -3 V with 150 mA of output supply current, and for a +3.3 V supply, the negative supply is equal to -2 V with 45 mA of output supply current.

Figure 36 shows the charging cycle when the supply voltage  $+V_S$  charges C1 through  $\Phi_1$  to ground. During this cycle, C1 quickly charges to reach the  $+V_S$  voltage. The discharge cycle then begins with switching  $\Phi_1$  off and switching  $\Phi_2$  on, as shown in Figure 37. When  $C1 = C2$ , the charge in C1 is divided between the two capacitors and slowly increases the voltage in C2 until it reaches a predetermined voltage (-3 V for +5 V supply and -2 V for +3.3 V supply). The typical charge pump charging and discharging frequency is 550 kHz with a 150  $\Omega$  load and no input signal; however, this frequency changes with different loads and supply conditions.

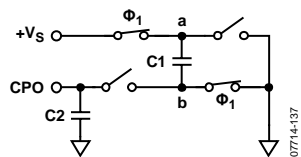

Figure 36. C1 Charging Cycle

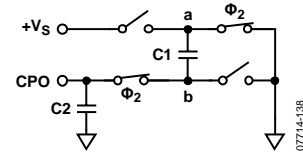

Figure 37. C1 Discharging Cycle

The ADA4858-3 specifications make it especially suitable for SD and HD video applications. It also allows dc-coupled video signals with its black level set to 0 V and its sync tip at -300 mV for YPbPr video.

The charge pump is always on, even when the power-down pin (PD) is enabled and the amplifiers are off. However, if a negative current is not used, the charge pump is in an idle state. Each amplifier needs -6.3 mA of current, which totals -19 mA for all three amplifiers. This means additional negative current may be available by the charge pump for external use. Pin 4 (CPO) is the charge pump output that provides access to the negative supply generated by the charge pump.

If the negative supply is used to power another device in the system, it is only possible for the 5 V supply operation. In the 3.3 V supply operation, the charge pump output current is very limited. The capacitor C2 placed at the CPO pin, which regulates the ripple of the negative voltage, can be used as a coupling capacitor for the external device. However, the charge pump current should be limited to a maximum of 50 mA for external use. When powering down the ADA4858-3, the charge pump is not affected and its output voltage and current are still available for external use.

It is recommended to use 1  $\mu\text{F}$  low ESR and low ESL capacitors for C1 and C2. These capacitors should be placed very close to the part. C1 should be placed between Pin C1\_a and Pin C1\_b, and C2 should be placed between Pin CPO and ground. If the charge pump ripple at the CPO pin is too high, larger capacitors (that is, 4.7  $\mu\text{F}$ ) can replace the 1  $\mu\text{F}$  at C1 and C2.

# APPLICATIONS INFORMATION

## GAIN CONFIGURATIONS

The ADA4858-3 is a single-supply, high speed, voltage feedback amplifier. Table 5 provides a convenient reference for quickly determining the feedback and gain set resistor values and bandwidth for common gain configurations.

Table 5. Recommended Values and Frequency Performance<sup>1</sup>

Gain	R <sub>F</sub> (Ω)	R <sub>G</sub> (Ω)	Small Signal -3 dB BW (MHz)	Large Signal 0.1 dB Flatness (MHz)
1	402	N/A	600	88
2	301	301	350	85
5	200	40	160	35

<sup>1</sup> Conditions: V<sub>S</sub> = 5 V, T<sub>A</sub> = 25°C, R<sub>L</sub> = 150 Ω.

Figure 38 and Figure 39 show the typical noninverting and inverting configurations and the recommended bypass capacitor values.

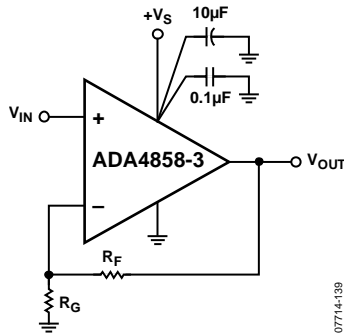

Figure 38. Noninverting Gain Configuration

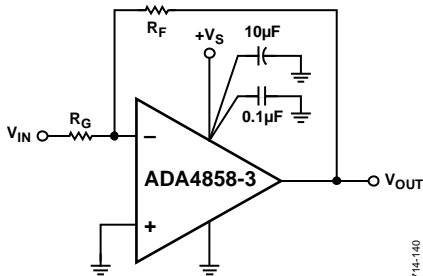

Figure 39. Inverting Gain Configuration

## DC-COUPLED VIDEO SIGNAL

The ADA4858-3 does not have a rail-to-rail output stage. The output can be within 1 V of the rails. Having a charge pump on board that can provide -3 V on a +5 V supply and -2 V on +3.3 V supply makes this part excellent for video applications. In dc-coupled applications, the black color has a 0 V voltage reference. This means that the output voltage should be able to reach 0 V, which is feasible with the presence of the charge pump. Figure 40 shows the schematic of a dc-coupled, single-supply application. It is similar to the dual-supply application in which the input is properly terminated with a 50 Ω resistor to ground. The amplifier itself is set at a gain of 2 to account for the input termination loss.

The choice of R<sub>F</sub> and R<sub>G</sub> should be carefully considered for maximum flatness vs. power dissipation trade-off. In this case, the flatness is over 90 MHz, which is more than the high definition video requirement.

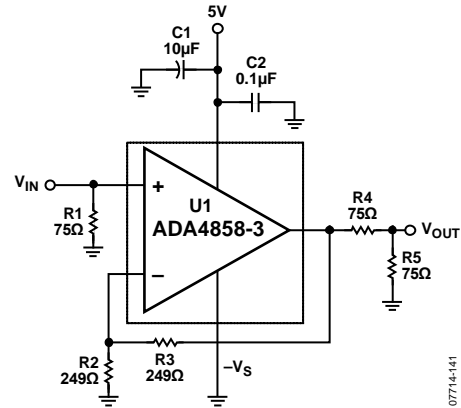

Figure 40. DC-Coupled, Single-Supply Schematic

## MULTIPLE VIDEO DRIVER

In applications requiring that multiple video loads be driven simultaneously, the ADA4858-3 can deliver 5 V supply operation. Figure 41 shows the ADA4858-3 configured with two video loads, and Figure 42 shows the two video load performances.

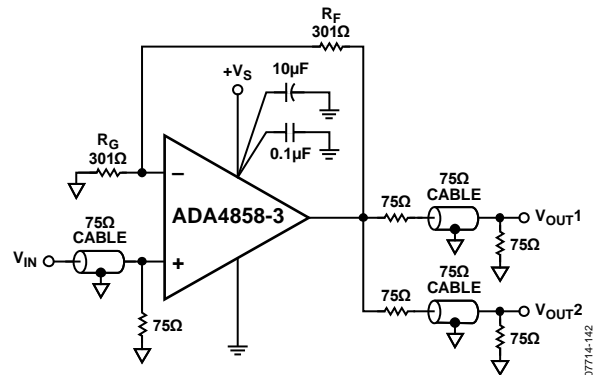

Figure 41. Video Driver Schematic for Two Video Loads

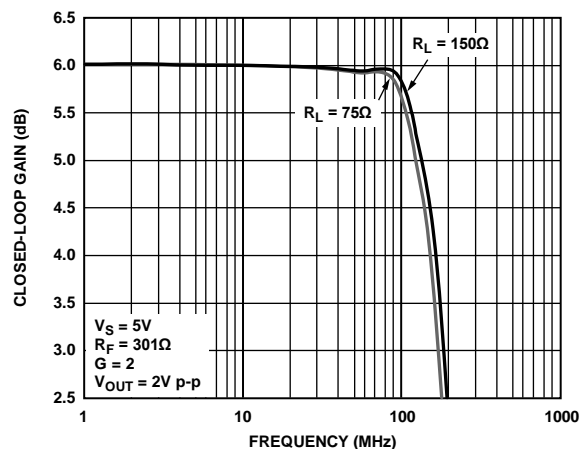

Figure 42. Large Signal Frequency Response for Various Loads

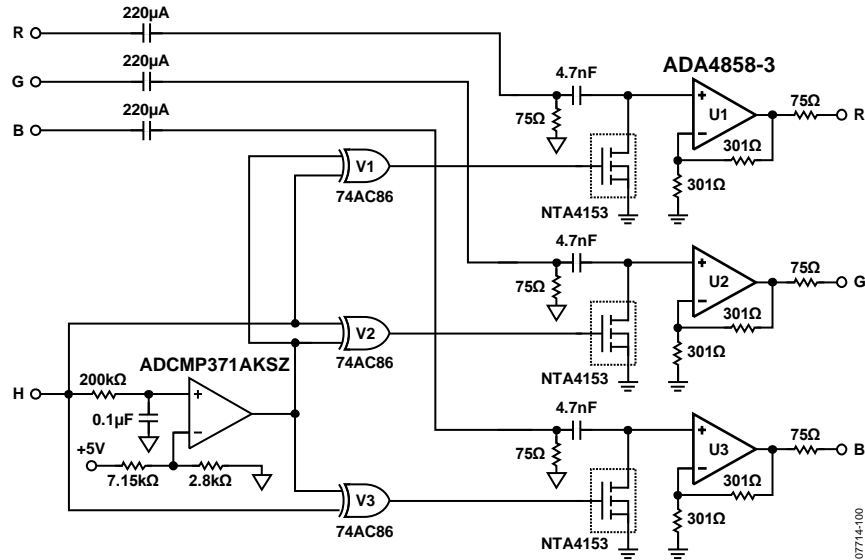

Figure 43. AC-Coupled Video Input with DC Restored Output

### DC RESTORE FUNCTION

Having a charge pump gives the ability to take an ac-coupled input signal and restore its dc 0 V reference. The simplest way of accomplishing this is to use the blanking interval and the H-sync signal to set the 0 V reference. Use the H-sync to sample the dc level during the blanking interval to charge a capacitor and hold the charge during the video signal. Figure 43 shows the schematic of the dc restored circuit.

The H-sync coming out of the video source can be either positive or negative. This is why a polarity correction circuit is used to produce only a positive going H-sync. The H-sync is fed to a comparator that produces a high voltage if H-sync is negative and a low voltage if the H-sync is positive. The H-sync is then fed to an XOR with the output of the comparator. If the original H-sync was negative, the output of the XOR is positive because of the logic high coming from the comparator, causing the XOR to act as an inverter. However, if the original H-sync is positive, it stays the same because the output of the comparator is low and the XOR acts as a buffer.

The result is a positive going H-sync triggering the MOSFET during the blanking interval. This shorts the 4.7 nF capacitor to ground, which causes it to charge up by the dc level of the current signal. When the H-sync goes low, the MOSFET opens and the capacitor holds the charge during the video signal, making the output signal referenced to ground or 0 V level.

### CLAMP AMPLIFIER

In some applications, a current output DAC driving a resistor may not have a negative supply available. In such case, the YPbPr video signal may be shifted up by 300 mV to avoid clamping the sync tip. These applications require a signal dc clamp on the output of the video driver to restore the dc level to 0 V reference. The ADA4858-3 has a charge pump that allows the output to swing negative; twice the sync tip (–600 mV) in G = 2 configuration.

Figure 44 shows the ADA4858-3 in a difference amplifier configuration. The video signal is connected to the noninverting side, and a dc bias of 600 mV is injected on the inverting side.

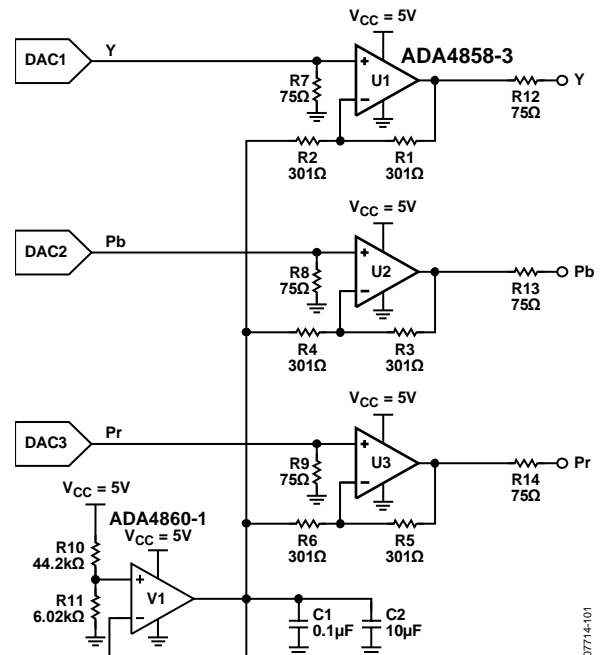

Figure 44. Clamp Amp



## PD (POWER-DOWN) PIN

The ADA4858-3 is equipped with a PD (power-down) pin for all three amplifiers. This allows the user to reduce the quiescent supply current when an amplifier is not active. The power-down threshold levels are derived from ground level. The amplifiers are powered down when the voltage applied to the PD pin is greater than a certain voltage from ground. In a 5 V supply application, the voltage is greater than 2 V, and in a 3.3 V supply application, the voltage is greater than 1.5 V. The amplifier is enabled whenever the PD pin is connected to ground. If the PD pin is not used, it is best to connect it to ground. Note that the power-down feature does not control the charge pump output voltage and current.

**Table 6. Power-Down Voltage Control**

PD Pin	5 V	3.3 V
Not active	<1.5 V	<1 V
Active	>2 V	>1.5 V

## POWER SUPPLY BYPASSING

Careful attention must be paid to bypassing the power supply pins of the ADA4858-3. High quality capacitors with low equivalent series resistance (ESR), such as multilayer ceramic capacitors (MLCCs), should be used to minimize supply voltage ripple and power dissipation. A large, usually tantalum, capacitor between 2.2  $\mu$ F to 47  $\mu$ F located in proximity to the ADA4858-3 is required to provide good decoupling for lower frequency signals. The actual value is determined by the circuit transient and frequency requirements. In addition, place 0.1  $\mu$ F MLCC decoupling capacitors as close to each of the power supply pins and across from both supplies as is physically possible, no more than 1/8 inch away. The ground returns should terminate immediately into the ground plane. Placing the bypass capacitor return close to the load return minimizes ground loops and improves performance.

## LAYOUT

As is the case with all high speed applications, careful attention to printed circuit board (PCB) layout details prevents associated board parasitics from becoming problematic. The ADA4858-3 can operate at up to 600 MHz; therefore, proper RF design techniques must be employed. The PCB should have a ground plane covering all unused portions of the component side of the board to provide a low impedance return path. Removing the ground plane on all layers from the area near and under the input and output pins reduces stray capacitance. Keep signal lines connecting the feedback and gain resistors as short as possible to minimize the inductance and stray capacitance associated with these traces. Place termination resistors and loads as close as possible to their respective inputs and outputs. Keep input and output traces as far apart as possible to minimize coupling (crosstalk) through the board. Adherence to microstrip or stripline design techniques for long signal traces (greater than 1 inch) is recommended. For more information on high speed board layout, see “A Practical Guide to High-Speed Printed-Circuit-Board Layout,” Analog Dialogue, Volume 39, Number 3, September 2005.

# OUTLINE DIMENSIONS

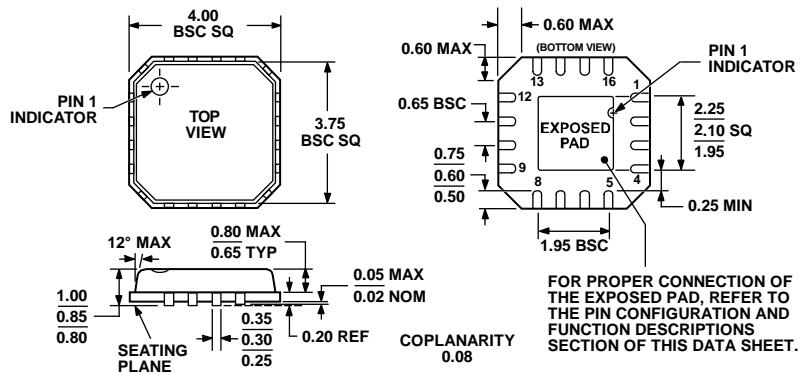

COMPLIANT TO JEDEC STANDARDS MO-220-VGGC

Figure 45.16-16-Lead Lead Frame Chip Scale Package [LFCSP\_VQ]  
 4 mm × 4 mm Body, Very Thin Quad  
 (CP-16-4)  
 Dimensions shown in millimeters

072808-A

## ORDERING GUIDE

Model <sup>1</sup>	Temperature Range	Package Description	Package Option	Ordering Quantity
ADA4858-3ACPZ-R2	-40°C to +105°C	16-Lead LFCSP_VQ	CP-16-4	250
ADA4858-3ACPZ-R7	-40°C to +105°C	16-Lead LFCSP_VQ	CP-16-4	1,500
ADA4858-3ACPZ-RL	-40°C to +105°C	16-Lead LFCSP_VQ	CP-16-4	5,000
ADA4858-3ACP-EBZ		Evaluation Board		

<sup>1</sup> Z = RoHS Compliant Part.

**NOTES**

**NOTES**

**NOTES**