

FAN6300A / FAN6300H

Highly Integrated Quasi-Resonant Current Mode PWM Controller

Features

- High-Voltage Startup
- Quasi-Resonant Operation
- Cycle-by-Cycle Current Limiting
- Peak-Current-Mode Control
- Leading-Edge Blanking (LEB)
- Internal Minimum t_{OFF}
- Internal 5 ms Soft-Start
- Over Power Compensation
- GATE Output Maximum Voltage
- Auto-Recovery Over-Current Protection(FB Pin)
- Auto-Recovery Open-Loop Protection(FB Pin)
- VDD Pin and Output Voltage (DET Pin) OVP Latched
- Low Frequency Operation (below 100 kHz) for FAN6300A
- High Frequency Operation (up to 190 kHz) for FAN6300H

Applications

- AC/DC NB Adapters
- Open-Frame SMPS

Description

The highly integrated FAN6300A/H of PWM controller provides several features to enhance the performance of flyback converters. FAN6300A is applied on quasi-resonant flyback converters where maximum operating frequency is below 100 kHz. FAN6300H is suitable for high-frequency operation (up to 190 kHz). A built-in HV startup circuit can provide more startup current to reduce the startup time of the controller. Once the V_{DD} voltage exceeds the turn-on threshold voltage, the HV startup function is disabled immediately to reduce power consumption. An internal valley voltage detector ensures power system operates at quasi-resonant operation over a wide-range of line voltage and any load conditions, as well as reducing switching loss to minimize switching voltage on drain of power MOSFET.

To minimize standby power consumption and light-load efficiency, a proprietary green-mode function provides off-time modulation to decrease switching frequency and perform extended valley voltage switching to keep to a minimum switching voltage. The operating frequency is limited by minimum t_{off} time, which is 38 μ s to 8 μ s in FAN6300A and 13 μ s to 3 μ s in FAN6300H, so FAN6300H can operate at higher switching frequency than FAN6300A.

FAN6300A/H controller also provides many protection functions. Pulse-by-pulse current limiting ensures the fixed-peak current limit level, even when a short circuit occurs. Once an open-circuit failure occurs in the feedback loop, the internal protection circuit disables PWM output immediately. As long as V_{DD} drops below the turn-off threshold voltage, the controller also disables PWM output. The gate output is clamped at 18 V to protect the power MOS from high gate-source voltage conditions. The minimum t_{OFF} time limit prevents the system frequency from being too high. If the DET pin triggers OVP, internal OTP is triggered and the power system enters latch-mode until AC power is removed.

The FAN6300A/H controller is available in the 8-pin Small Outline Package (SOP).

Ordering Information

Part Number	Operating Temperature Range	Package	Packing Method
FAN6300AMY	-40°C to +125°C	8-Lead, Small Outline Package (SOP)	Tape & Reel
FAN6300HMY			

 For Fairchild's definition of Eco Status, please visit: http://www.fairchildsemi.com/company/green/rohs_green.html

Application Diagram

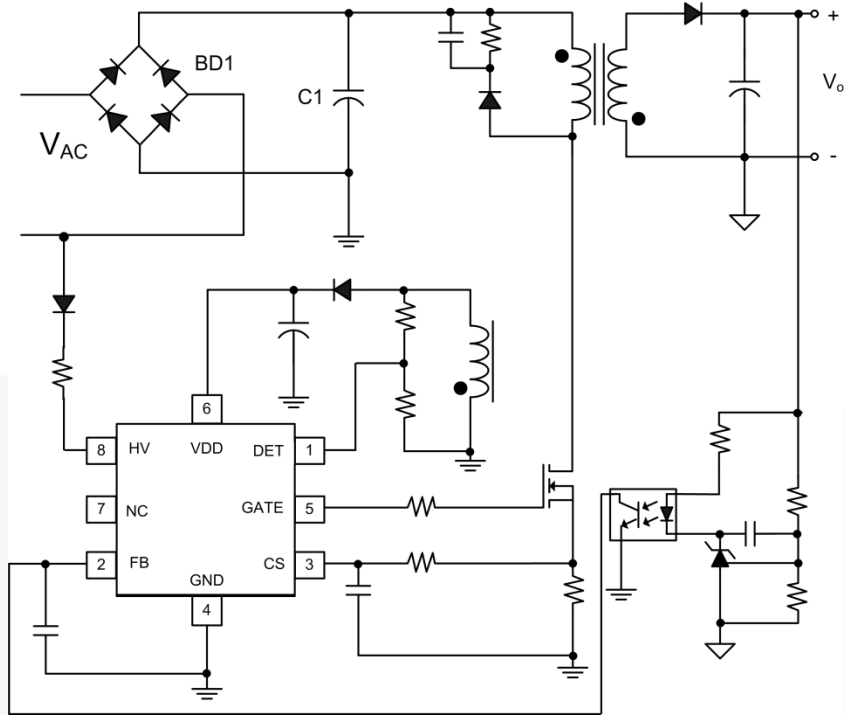

Figure 1. Typical Application

Internal Block Diagram

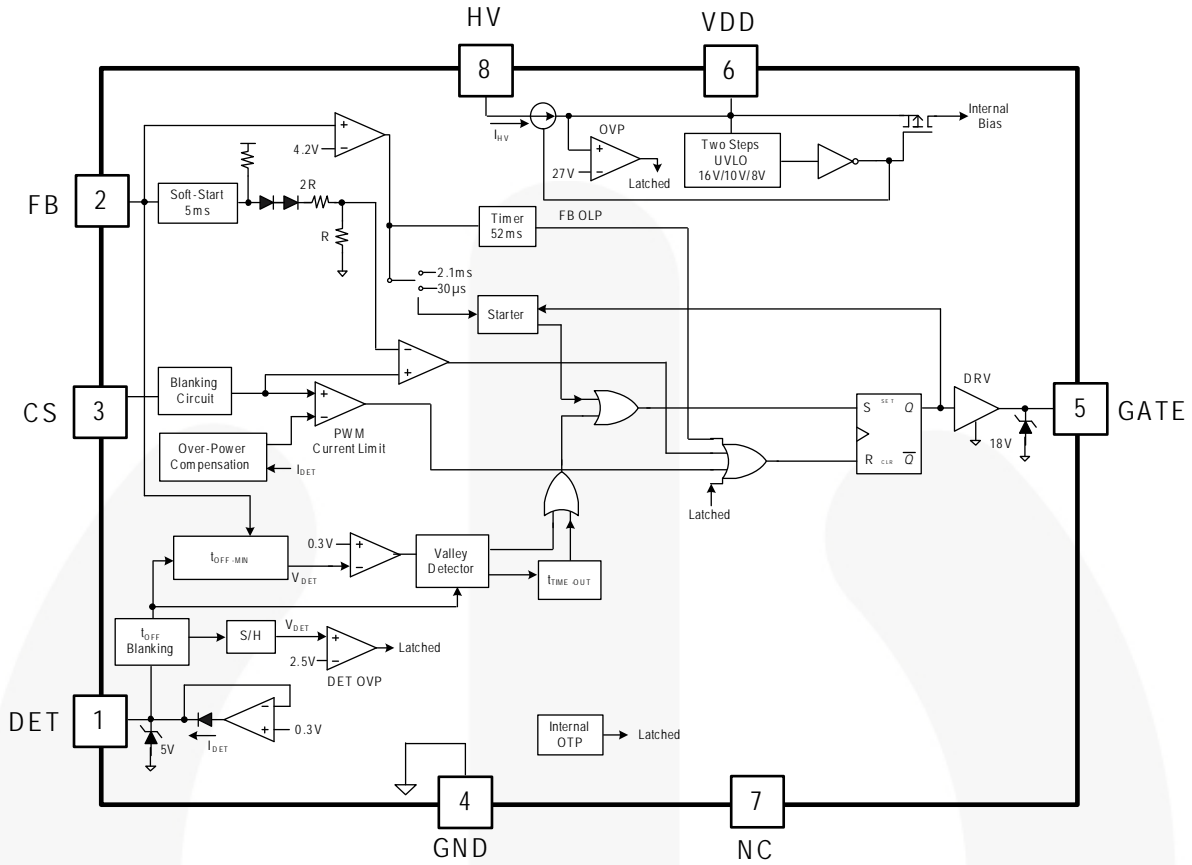
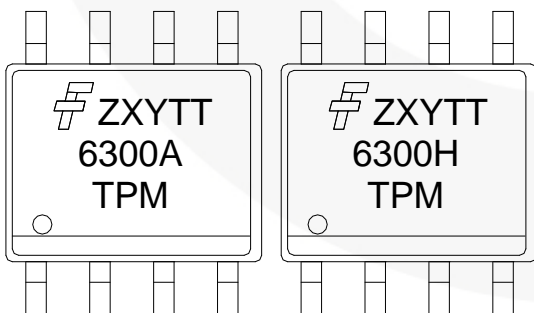

Figure 2. Functional Block Diagram

Marking Information



- F**: Fairchild Logo
- Z**: Plant Code
- X**: Year Code
- Y**: Week Code
- TT**: Die Run Code
- T**: Package Type (M = SOP)
- P**: Y = Green Package
- M**: Manufacturing Flow Code

Figure 3. Marking Diagram

Pin Configuration

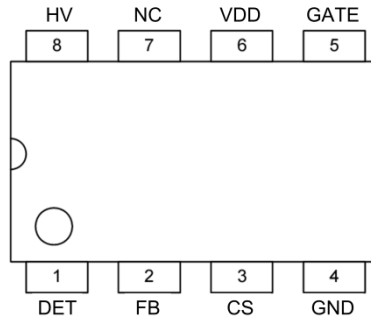

Figure 4. Pin Configuration

Pin Definitions

Pin #	Name	Description
1	DET	<p>This pin is connected to an auxiliary winding of the transformer via resistors of the divider for the following purposes:</p> <ul style="list-style-type: none"> – Generates a ZCD signal once the secondary-side switching current falls to zero. – Produces an offset voltage to compensate the threshold voltage of the peak current limit to provide a constant power limit. The offset is generated in accordance with the input voltage when PWM signal is enabled. – Detects the valley voltage of the switching waveform to achieve the valley voltage switching and minimize the switching losses. <p>A voltage comparator and a 2.5 V reference voltage develop a output OVP protection. The ratio of the divider decides what output voltage to stop gate, as an optical coupler and secondary shunt regulator are used.</p>
2	FB	<p>The feedback pin should be connected to the output of the error amplifier for achieving the voltage control loop. The FB should be connected to the output of the optical coupler if the error-amplifier is equipped at the secondary-side of the power converter.</p> <p>For the primary-side control application, FB is applied to connect a RC network to the ground for feedback-loop compensation.</p> <p>The input impedance of this pin is a 5 kΩ equivalent resistance. A 1/3 attenuator connected between the FB and the PWM circuit is used for the loop-gain attenuation. FAN6300A/H performs an open-loop protection once the FB voltage is higher than a threshold voltage (around 4.2 V) more than 55 ms.</p>
3	CS	Input to the comparator of the over-current protection. A resistor senses the switching current and the resulting voltage is applied to this pin for the cycle-by-cycle current limit.
4	GND	The power ground and signal ground. A 0.1 μF decoupling capacitor placed between VDD and GND is recommended.
5	GATE	Totem-pole output generates the PWM signal to drive the external power MOSFET. The clamped gate output voltage is 18 V.
6	VDD	Power supply. The threshold voltages for startup and turn-off are 16 V and 10 V, respectively. The startup current is less than 20 μA and the operating current is lower than 4.5 mA.
7	NC	No connect
8	HV	High-voltage startup.

Absolute Maximum Ratings

Stresses exceeding the absolute maximum ratings may damage the device. The device may not function or be operable above the recommended operating conditions and stressing the parts to these levels is not recommended. In addition, extended exposure to stresses above the recommended operating conditions may affect device reliability. The absolute maximum ratings are stress ratings only.

Symbol	Parameter	Min.	Max.	Unit
V _{DD}	DC Supply Voltage		30	V
V _{HV}	HV		500	V
V _H	GATE	-0.3	25.0	V
V _L	V _{FB} , V _{CS} , V _{DET}	-0.3	7.0	V
P _D	Power Dissipation		400	mW
T _J	Operating Junction Temperature		+150	°C
T _{STG}	Storage Temperature Range	-55	+150	°C
T _L	Lead Temperature (Soldering 10 Seconds)		+270	°C
ESD	Human Body Model, JEDEC:JESD22-A114		3.0	KV
	Charged Device Model, JEDEC:JESD22-C101		1.5	

Notes:

1. Stresses beyond those listed under Absolute Maximum Ratings may cause permanent damage to the device.
2. All voltage values, except differential voltages, are given with respect to GND pin.

Recommended Operating Conditions

The Recommended Operating Conditions table defines the conditions for actual device operation. Recommended operating conditions are specified to ensure optimal performance to the datasheet specifications. Fairchild does not recommend exceeding them or designing to Absolute Maximum Ratings.

Symbol	Parameter	Conditions	Min.	Typ.	Max.	Unit
T _A	Operating Ambient Temperature		-40		+125	°C

Electrical Characteristics

Unless otherwise specified, $V_{DD}=10\sim 25\text{ V}$, $T_A=-40^\circ\text{C}\sim 125^\circ\text{C}$ ($T_A=T_J$).

Symbol	Parameter	Conditions	Min.	Typ.	Max.	Unit
V_{DD} Section						
V _{OP}	Continuously Operating Voltage				25	V
V _{DD-ON}	Turn-On Threshold Voltage		15	16	17	V
V _{DD-PWM-OFF}	PWM Off Threshold Voltage		9	10	11	V
V _{DD-OFF}	Turn-Off Threshold Voltage		7	8	9	V
I _{DD-ST}	Startup Current	V _{DD} =V _{DD-ON} -0.16 V GATE Open		10	20	μA
I _{DD-OP}	Operating Current	V _{DD} =15 V, f _S =60 KHz, C _L =2 nF		4.5	5.5	mA
I _{DD-GREEN}	Green-Mode Operating Supply Current (Average)	V _{DD} =15 V, f _S =2 KHz, C _L =2 nF			3.5	mA
I _{DD-PWM-OFF}	Operating Current at PWM-Off Phase	V _{DD} =V _{DD-PWM-OFF} -0.5 V	70	80	90	μA
V _{DD-OVP}	V _{DD} Over-Voltage Protection (Latch-Off)		26	27	28	V
t _{VDD-OVP}	V _{DD} OVP Debounce Time		100	150	200	μs
I _{DD-LATCH}	V _{DD} OVP Latch-Up Holding Current	V _{DD} =5 V		42		μA
HV Startup Current Source Section						
V _{HV-MIN}	Minimum Startup Voltage on Pin HV				50	V
I _{HV}	Supply Current Drawn from Pin HV	V _{AC} =90 V(V _{DC} =120V) V _{DD} =0 V	1.5		4.0	mA
I _{HV-LC}	Leakage Current After Startup	HV=500 V, V _{DD} =V _{DD-OFF} +1 V		1	20	μA
Feedback Input Section						
A _V	Input-Voltage to Current Sense Attenuation	$A_V = \Delta V_{CS} / \Delta V_{FB}$ $0 < V_{CS} < 0.9$	1/2.75	1/3.00	1/3.25	V/V
Z _{FB}	Input Impedance		3	5	7	KΩ
I _{OZ}	Bias Current	FB=V _{OZ}		1.2	2	mA
V _{OZ}	Zero Duty-Cycle Input Voltage		0.8	1.0	1.2	V
V _{FB-OLP}	Open Loop Protection Threshold Voltage		3.9	4.2	4.5	V
t _{D-OLP}	Debounce Time for Open-Loop/Overload Protection		46	52	62	ms
t _{SS}	Internal Soft-Start Time			5		ms

Continued on the following page...

Electrical Characteristics (Continued)Unless otherwise specified, $V_{DD}=10\sim 25\text{ V}$, $T_A=-40^\circ\text{C}\sim 125^\circ\text{C}$ ($T_A=T_J$).

Symbol	Parameter	Conditions	Min.	Typ.	Max.	Unit
DET Pin OVP and Valley Detection Section						
$V_{DET-OVP}$	Comparator Reference Voltage		2.45	2.50	2.55	V
A_V	Open-Loop Gain ⁽³⁾			60		dB
BW	Gain Bandwidth ⁽³⁾			1		MHz
V_{V-HIGH}	Output High Voltage		4.5			V
V_{V-LOW}	Output Low Voltage				0.5	V
$t_{DET-OVP}$	Output OVP (Latched) Debounce Time		100	150	200	μs
$I_{DET-SOURCE}$	Maximum Source Current	$V_{DET}=0\text{ V}$			1	mA
$V_{DET-HIGH}$	Upper Clamp Voltage	$I_{DET}=-1\text{ mA}$			5	V
$V_{DET-LOW}$	Lower Clamp Voltage	$I_{DET}=1\text{ mA}$	0.1	0.3		V
$t_{VALLEY-DELAY}$	Delay Time from Valley-Signal Detected to Output Turn-On ⁽³⁾			200		ns
$t_{OFF-BNK}$	Leading-Edge-Blanking Time for DET when PWM MOS Turns Off ⁽³⁾	FAN6300A		4.0		μs
		FAN6300H		1.5		
$t_{TIME-OUT}$	Time-Out after $t_{OFF-MIN}$	FAN6300A		9		μs
		FAN6300H		5		
Oscillator Section						
t_{ON-MAX}	Maximum On-Time		38	45	54	μs
$t_{OFF-MIN}$	Minimum Off-Time	$V_{FB}\geq V_N$, FAN6300A		8		μs
		$V_{FB}\geq V_N$, FAN6300H		3		μs
		$V_{FB}=V_G$, FAN6300A		38		μs
		$V_{FB}=V_G$, FAN6300H		13		μs
V_N	Beginning of Green-On Mode at FB Voltage Level		1.95	2.10	2.25	V
V_G	Beginning of Green-Off Mode at FB Voltage Level		1.0	1.2	1.4	V
ΔV_{FBG}	Green-Off Mode V_{FB} Hysteresis Voltage		0.05	0.10	0.20	V
$t_{STARTER}$	Start Timer (Time-Out Timer)	$V_{FB}<V_G$	1.8	2.1	2.4	ms
		$V_{FB}>V_{FB-OLP}$	25	30	45	μs
Output Section						
V_{OL}	Output Voltage Low	$V_{DD}=15\text{ V}$, $I_O=150\text{ mA}$			1.5	V
V_{OH}	Output Voltage High	$V_{DD}=12\text{ V}$, $I_O=150\text{ mA}$	7.5			V
t_R	Rising Time			145	200	ns
t_F	Falling Time			55	120	ns
V_{CLAMP}	Gate Output Clamping Voltage		16.7	18.0	19.3	V

Continued on following page...

Electrical Characteristics(Continued)Unless otherwise specified, $V_{DD}=10\sim 25\text{ V}$, $T_A=-40^\circ\text{C} \sim 125^\circ\text{C}$ ($T_A=T_J$).

Symbol	Parameter	Conditions	Min.	Typ.	Max.	Unit
Current Sense Section						
t_{PD}	Delay to Output		20	150	200	ns
V_{LIMIT}	Limit Voltage on CS Pin for Over-Power Compensation	$I_{DET} < 74.41\ \mu\text{A}$	0.82	0.85	0.88	V
		$I_{DET}=550\ \mu\text{A}$	0.380	0.415	0.450	V
V_{SLOPE}	Slope Compensation ⁽³⁾	$t_{ON}=45\ \mu\text{s}$		0.3		V
		$t_{ON}=0\ \mu\text{s}$		0.1		V
t_{BNK}	Leading-Edge-Blanking Time (MOS Turns ON)		525	625	725	ns
V_{CS-H}	V_{CS} Clamped High Voltage once CS Pin Floating	CS Pin Floating	4.5		5.0	V
t_{CS-H}	Delay Time once CS Pin Floating	CS Pin Floating		150		μs
Internal Over-Temperature Protection Section						
T_{OTP}	Internal Threshold Temperature for OTP ⁽³⁾			+140		$^\circ\text{C}$
$T_{OTP-HYST}$	Hysteresis Temperature for Internal OTP ⁽³⁾			+15		$^\circ\text{C}$

Note:

- Guaranteed by design.

Typical Performance Characteristics

Graphs are normalized at $T_A=25^\circ\text{C}$.

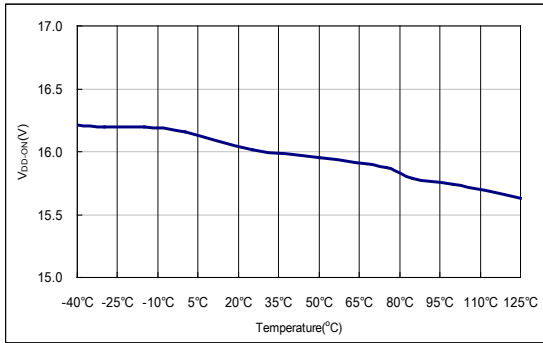

Figure 5. Turn-On Threshold Voltage

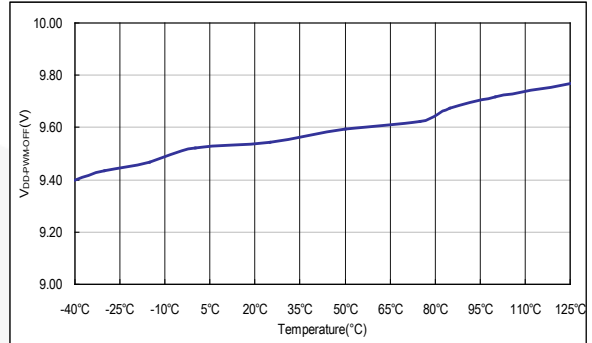

Figure 6. PWM-Off Threshold Voltage

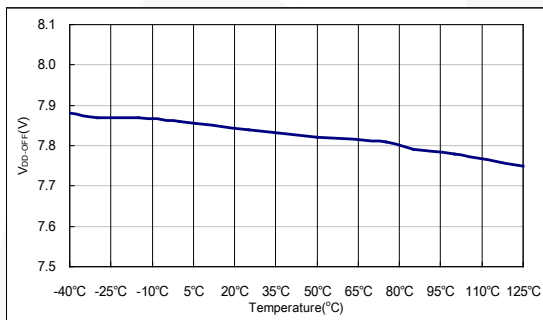

Figure 7. Turn-Off Threshold Voltage

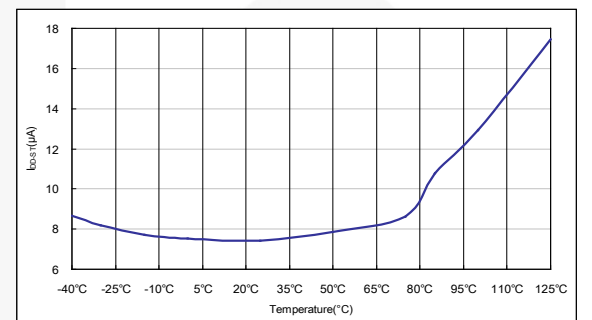

Figure 8. Startup Current

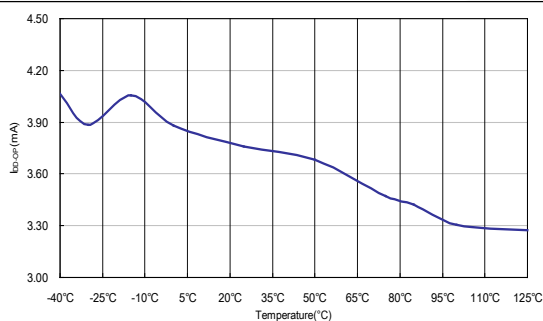

Figure 9. Operating Current

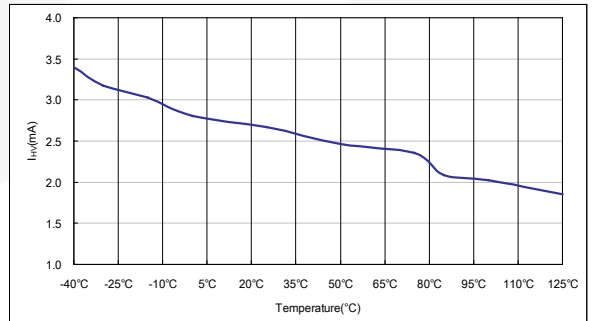

Figure 10. Supply Current Drawn From HV Pin

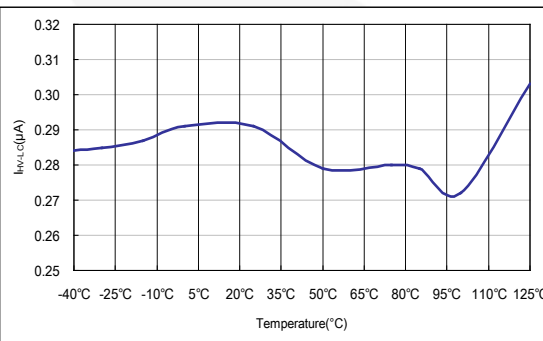

Figure 11. Leakage Current After Startup

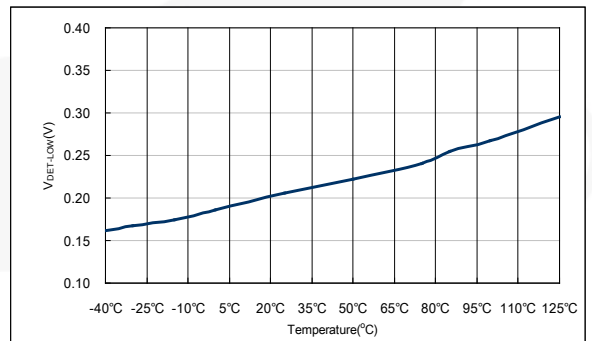

Figure 12. Lower Clamp Voltage

Typical Performance Characteristics (Continued)

These characteristic graphs are normalized at $T_A = 25^\circ\text{C}$.

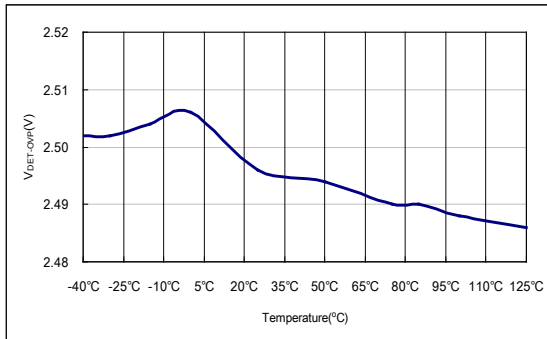

Figure 13. Comparator Reference Voltage

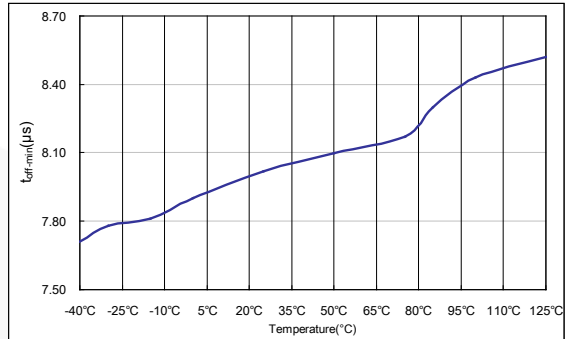

Figure 14. Minimum Off Time ($V_{FB} > V_N$)

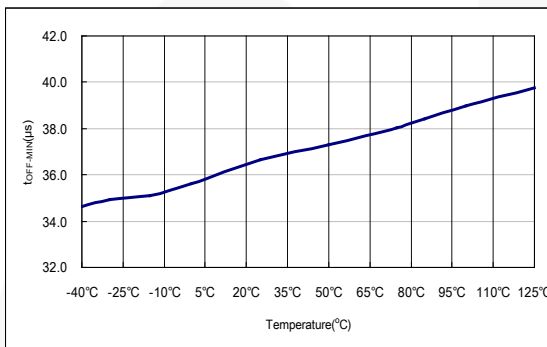

Figure 15. Minimum Off Time ($V_{FB} = V_G$)

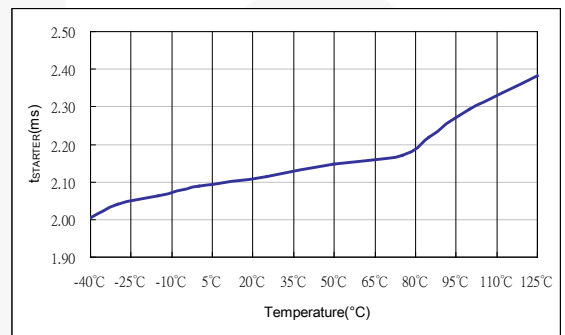

Figure 16. Start Timer ($V_{FB} < V_G$)

Operation Description

The FAN6300A/H PWM controller integrates designs to enhance the performance of flyback converters. An internal valley voltage detector ensures power system operates at Quasi-Resonant (QR) operation across a wide range of line voltage. The following descriptions highlight some of the features of the FAN6300A/H.

Startup Current

For startup, the HV pin is connected to the line input or bulk capacitor through an external diode and resistor, R_{HV} , which are recommended as 1N4007 and 100 k Ω . Typical startup current drawn from the HV pin is 1.2 mA and it charges the hold-up capacitor through the diode and resistor. When the V_{DD} voltage level reaches V_{DD-ON} , the startup current switches off. At this moment, the V_{DD} capacitor only supplies the FAN6300A/H to maintain V_{DD} until the auxiliary winding of the main transformer provides the operating current.

Valley Detection

The DET pin is connected to an auxiliary winding of the transformer via resistors of the divider to generate a valley signal once the secondary-side switching current discharges to zero. It detects the valley voltage of the switching waveform to achieve the valley voltage switching. This ensures QR operation, minimizes switching losses, and reduces EMI. Figure 17 shows divider resistors R_{DET} and R_A . R_{DET} is recommended as 150 k Ω to 220 k Ω to achieve valley voltage switching. When V_{AUX} (in Figure 17) is negative, the DET pin voltage is clamped to 0.3 V.

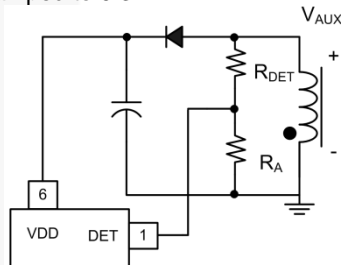

Figure 17. Valley Detect Section

The internal timer (minimum t_{OFF} time) prevents gate retriggering within 8 μ s (3 μ s for H version) after the gate signal going-low transition. The minimum t_{OFF} limit prevents system frequency being too high. Figure 18 shows a typical drain voltage waveform with first valley switching.

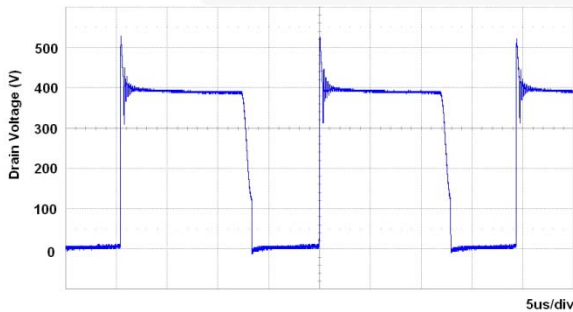

Figure 18. First Valley Switching

Green-Mode Operation

The proprietary green-mode function provides off-time modulation to linearly decrease the switching frequency under light-load conditions. V_{FB} , which is derived from the voltage feedback loop, is taken as the reference. In Figure 19, once V_{FB} is lower than V_N , $t_{OFF-MIN}$ increases linearly with lower V_{FB} . The valley voltage detection signal does not start until $t_{OFF-MIN}$ finishes. Therefore, the valley detect circuit is activated until $t_{OFF-MIN}$ finishes, which decreases the switching frequency and provides extended valley voltage switching. However, in very light load condition, it might fail to detect the valley voltage after the $t_{OFF-MIN}$ expires. Under this condition, an internal $t_{TIME-OUT}$ signal initiates a new cycle start after a 9 μ s delay (with 5 μ s delay for H version). Figure 20 and Figure 21 show the two different conditions.

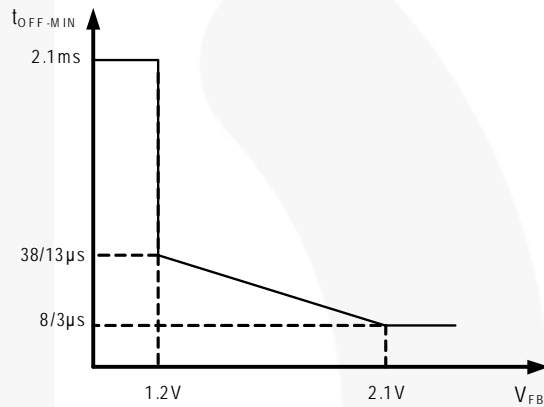

Figure 19. V_{FB} vs. $t_{OFF-MIN}$ Curve

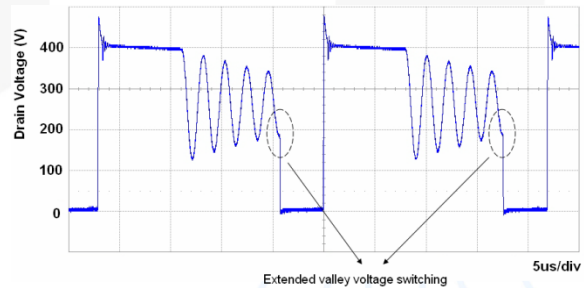

Figure 20. QR Operation in Extended Valley Voltage Detection Mode

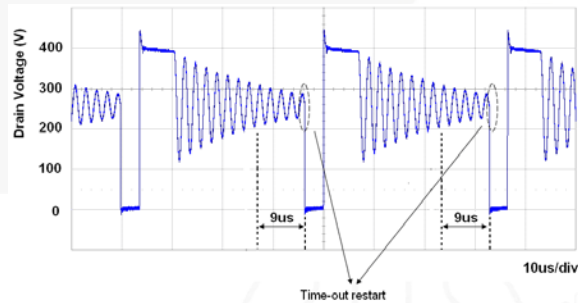

Figure 21. Internal $t_{TIME-OUT}$ Initiates New Cycle After Failure to Detect Valley Voltage (with 5 μ s Delay for FAN6300H version)

Current Sensing and PWM Current Limiting

Peak-current-mode control is utilized to regulate output voltage and provide pulse-by-pulse current limiting. The switch current is detected by a sense resistor into the CS pin. The PWM duty cycle is determined by this current-sense signal and V_{FB} . When the voltage on CS reaches around $V_{LIMIT} = (V_{FB}-1.2)/3$, the switch cycle is terminated immediately. V_{LIMIT} is internally clamped to a variable voltage around 0.85 V for output power limit.

Leading-Edge Blanking (LEB)

Each time the power MOSFET switches on, a turn-on spike occurs on the sense resistor. To avoid premature termination of the switching pulse, lead-edge blanking time is built in. During the blanking period, the current limit comparator is disabled; it cannot switch off the gate driver.

Under-Voltage Lockout (UVLO)

The turn-on, PWM-off, and turn-off thresholds are fixed internally at 16/10/8 V. During startup, the startup capacitor must be charged to 16 V through the startup resistor to enable the IC. The hold-up capacitor continues to supply V_{DD} until energy can be delivered from the auxiliary winding of the main transformer. V_{DD} must not drop below 10 V during this startup process. This UVLO hysteresis window ensures that hold-up capacitor is adequate to supply V_{DD} during startup.

Gate Output

The BiCMOS output stage is a fast totem-pole gate driver. Cross conduction has been avoided to minimize heat dissipation, increase efficiency, and enhance reliability. The output driver is clamped by an internal 18 V Zener diode to protect power MOSFET transistors against undesired over-voltage gate signals.

Over-Power Compensation

To compensate this variation for wide AC input range, the DET pin produces an offset voltage to compensate the threshold voltage of the peak current limit to provide a constant-power limit. The offset is generated in accordance with the input voltage when PWM signal is enabled. This results in a lower current limit at high-line inputs than low-line inputs. At fixed-load condition, the CS limit is higher when the value of R_{DET} is higher. R_{DET} also affects the H/L line constant power limit.

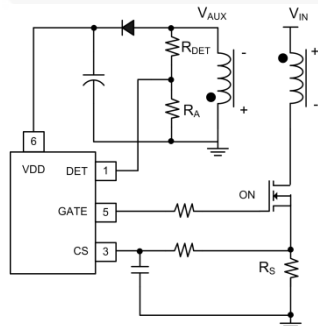

Figure 22. H/L Line Constant Power Limit Compensated by DET Pin

V_{DD} Over-Voltage Protection

V_{DD} over-voltage protection prevents damage due to abnormal conditions. Once the V_{DD} voltage is over the V_{DD} over-voltage protection voltage (V_{DD-OVP}) and lasts for t_{VDDOVP} , the PWM pulse is disabled until the V_{DD} voltage drops below the UVLO, then starts again.

Output Over-Voltage Protection

The output over-voltage protection works by the sampling voltage, as shown in Figure 23, after switch-off sequence. A 4 μ s (1.5 μ s for H version) blanking time ignores the leakage inductance ringing. A voltage comparator and a 2.5 V reference voltage develop an output OVP protection. The ratio of the divider determines the sampling voltage of the stop gate, as an optical coupler and secondary shunt regulator are used. If the DET pin OVP is triggered, the power system enters latch-mode until AC power is removed.

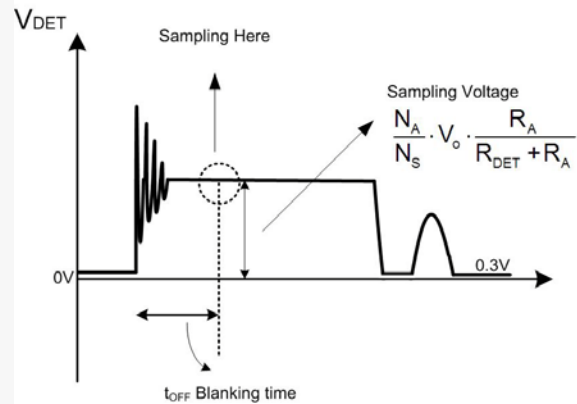
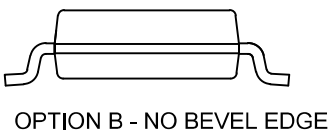
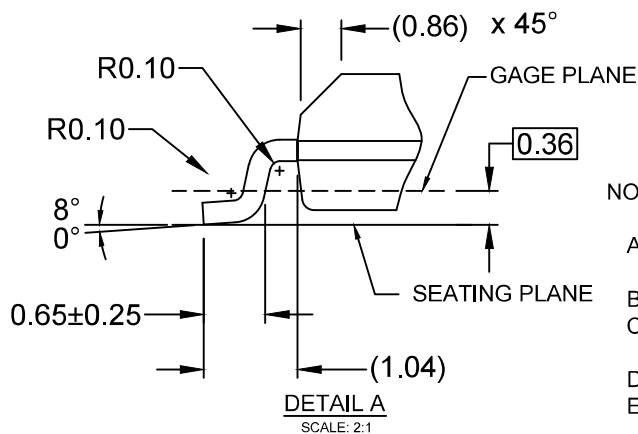
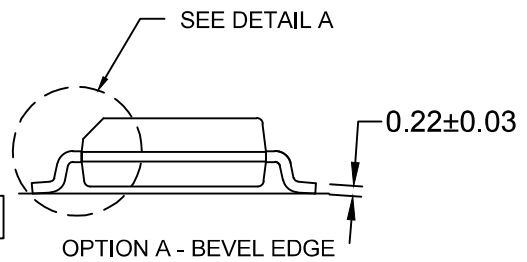
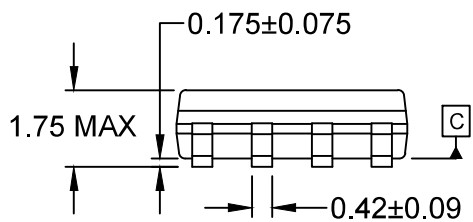
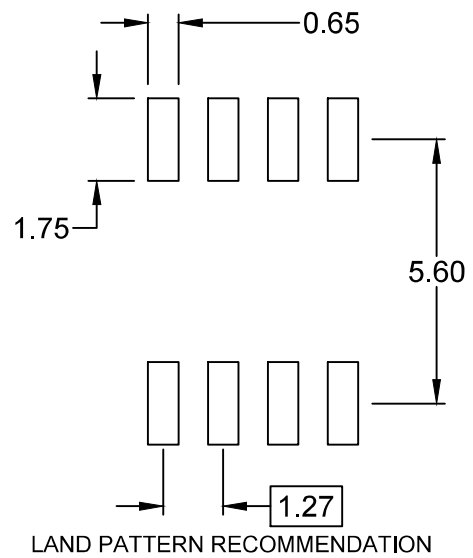
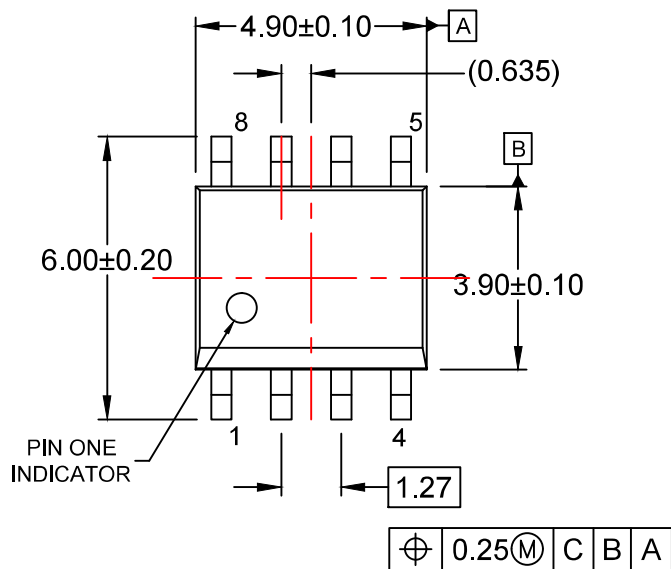

Figure 23. Voltage Sampled After 4 μ s (1.5 μ s for FAN6300H version) Blanking Time After Switch-Off Sequence

Short-Circuit and Open-Loop Protection

The FB voltage increases every time the output of the power supply is shorted or overloaded. If the FB voltage remains higher than a built-in threshold for longer than t_{D-OLP} , PWM output is turned off. As PWM output is turned-off, the supply voltage V_{DD} begins decreasing.

When V_{DD} goes below the PWM-off threshold of 10 V, V_{DD} decreases to 8 V, then the controller is totally shut down. V_{DD} is charged up to the turn-on threshold voltage of 16 V through the startup resistor until PWM output is restarted. This protection feature continues as long as the overloading condition persists. This prevents the power supply from overheating due to overloading.



NOTES:

- A) THIS PACKAGE CONFORMS TO JEDEC MS-012, VARIATION AA.
- B) ALL DIMENSIONS ARE IN MILLIMETERS.
- C) DIMENSIONS DO NOT INCLUDE MOLD FLASH OR BURRS.
- D) LANDPATTERN STANDARD: SOIC127P600X175-8M
- E) DRAWING FILENAME: M08Arev16





TRADEMARKS

The following includes registered and unregistered trademarks and service marks, owned by Fairchild Semiconductor and/or its global subsidiaries, and is not intended to be an exhaustive list of all such trademarks.

AccuPower™
AttitudeEngine™
Awinda®
AX-CAP®*
BitSiC™
Build it Now™
CorePLUS™
CorePOWER™
CROSSVOL™
CTL™
Current Transfer Logic™
DEUXPEED®
Dual Cool™
EcoSPARK®
EfficientMax™
ESBC™
F®
Fairchild®
Fairchild Semiconductor®
FACT Quiet Series™
FACT®
FastvCore™
FETBench™
FPS™

F-PFS™
FRFET®
Global Power Resource™
GreenBridge™
Green FPS™
Green FPS™ e-Series™
Gmax™
GTO™
IntelliMAX™
ISOPLANAR™
Making Small Speakers Sound Louder and Better™
MegaBuck™
MICROCOUPLER™
MicroFET™
MicroPak™
MicroPak2™
MillerDrive™
MotionMax™
MotionGrid®
MTi®
MTx®
MVN®
mWSaver®
OptoHiT™
OPTOLOGIC®

OPTOPLANAR®
Power Supply WebDesigner™
PowerTrench®
PowerXS™
Programmable Active Droop™
QFET®
QS™
Quiet Series™
RapidConfigure™
Saving our world, 1mW/W/kW at a time™
SignalWise™
SmartMax™
SMART START™
Solutions for Your Success™
SPM®
STEALTH™
SuperFET®
SuperSOT™-3
SuperSOT™-6
SuperSOT™-8
SupreMOS®
SyncFET™
Sync-Lock™

SYSTEM GENERAL®
TinyBoost®
TinyBuck®
TinyCalc™
TinyLogic®
TINYOPTO™
TinyPower™
TinyPWM™
TinyWire™
TranSiC™
TriFault Detect™
TRUECURRENT®*
µSerDes™
SerDes®
UHC®
Ultra FRFET™
UniFET™
VCX™
VisualMax™
VoltagePlus™
XS™
Xsens™
仙童®

* Trademarks of System General Corporation, used under license by Fairchild Semiconductor.

DISCLAIMER

FAIRCHILD SEMICONDUCTOR RESERVES THE RIGHT TO MAKE CHANGES WITHOUT FURTHER NOTICE TO ANY PRODUCTS HEREIN TO IMPROVE RELIABILITY, FUNCTION, OR DESIGN. TO OBTAIN THE LATEST, MOST UP-TO-DATE DATASHEET AND PRODUCT INFORMATION, VISIT OUR WEBSITE AT [HTTP://WWW.FAIRCHILDSEMI.COM](http://www.fairchildsemi.com). FAIRCHILD DOES NOT ASSUME ANY LIABILITY ARISING OUT OF THE APPLICATION OR USE OF ANY PRODUCT OR CIRCUIT DESCRIBED HEREIN; NEITHER DOES IT CONVEY ANY LICENSE UNDER ITS PATENT RIGHTS, NOR THE RIGHTS OF OTHERS. THESE SPECIFICATIONS DO NOT EXPAND THE TERMS OF FAIRCHILD'S WORLDWIDE TERMS AND CONDITIONS, SPECIFICALLY THE WARRANTY THEREIN, WHICH COVERS THESE PRODUCTS.

AUTHORIZED USE

Unless otherwise specified in this data sheet, this product is a standard commercial product and is not intended for use in applications that require extraordinary levels of quality and reliability. This product may not be used in the following applications, unless specifically approved in writing by a Fairchild officer: (1) automotive or other transportation, (2) military/aerospace, (3) any safety critical application – including life critical medical equipment – where the failure of the Fairchild product reasonably would be expected to result in personal injury, death or property damage. Customer's use of this product is subject to agreement of this Authorized Use policy. In the event of an unauthorized use of Fairchild's product, Fairchild accepts no liability in the event of product failure. In other respects, this product shall be subject to Fairchild's Worldwide Terms and Conditions of Sale, unless a separate agreement has been signed by both Parties.

ANTI-COUNTERFEITING POLICY

Fairchild Semiconductor Corporation's Anti-Counterfeiting Policy. Fairchild's Anti-Counterfeiting Policy is also stated on our external website, www.fairchildsemi.com, under Terms of Use

Counterfeiting of semiconductor parts is a growing problem in the industry. All manufacturers of semiconductor products are experiencing counterfeiting of their parts. Customers who inadvertently purchase counterfeit parts experience many problems such as loss of brand reputation, substandard performance, failed applications, and increased cost of production and manufacturing delays. Fairchild is taking strong measures to protect ourselves and our customers from the proliferation of counterfeit parts. Fairchild strongly encourages customers to purchase Fairchild parts either directly from Fairchild or from Authorized Fairchild Distributors who are listed by country on our web page cited above. Products customers buy either from Fairchild directly or from Authorized Fairchild Distributors are genuine parts, have full traceability, meet Fairchild's quality standards for handling and storage and provide access to Fairchild's full range of up-to-date technical and product information. Fairchild and our Authorized Distributors will stand behind all warranties and will appropriately address any warranty issues that may arise. Fairchild will not provide any warranty coverage or other assistance for parts bought from Unauthorized Sources. Fairchild is committed to combat this global problem and encourage our customers to do their part in stopping this practice by buying direct or from authorized distributors.

PRODUCT STATUS DEFINITIONS

Definition of Terms

Datasheet Identification	Product Status	Definition
Advance Information	Formative / In Design	Datasheet contains the design specifications for product development. Specifications may change in any manner without notice.
Preliminary	First Production	Datasheet contains preliminary data; supplementary data will be published at a later date. Fairchild Semiconductor reserves the right to make changes at any time without notice to improve design.
No Identification Needed	Full Production	Datasheet contains final specifications. Fairchild Semiconductor reserves the right to make changes at any time without notice to improve the design.
Obsolete	Not In Production	Datasheet contains specifications on a product that is discontinued by Fairchild Semiconductor. The datasheet is for reference information only.