

Analog Devices Welcomes Hittite Microwave Corporation

NO CONTENT ON THE ATTACHED DOCUMENT HAS CHANGED



HMC327* Product Page Quick Links

Last Content Update: 08/30/2016

[Comparable Parts](#)

View a parametric search of comparable parts

[Evaluation Kits](#)

- HMC327MS8G Evaluation Board

[Documentation](#)

Application Notes

- Broadband Biasing of Amplifiers General Application Note
- MMIC Amplifier Biasing Procedure Application Note
- Thermal Management for Surface Mount Components General Application Note

Data Sheet

- HMC327 Data Sheet

[Tools and Simulations](#)

- HMC327 S-Parameter

[Reference Materials](#)

Quality Documentation

- HMC Legacy PCN: MS##, MS##E and MS##G,MS##GE packages - Relocation of pre-existing production equipment to new building
- Package/Assembly Qualification Test Report: MS8G (QTR: 2014-00393)
- PCN: MS, QS, SOT, SOIC packages - Sn/Pb plating vendor change
- Semiconductor Qualification Test Report: GaAs HBT-B (QTR: 2013-00229)

[Design Resources](#)

- HMC327 Material Declaration
- PCN-PDN Information
- Quality And Reliability
- Symbols and Footprints

[Discussions](#)

View all HMC327 EngineerZone Discussions

[Sample and Buy](#)

Visit the product page to see pricing options

[Technical Support](#)

Submit a technical question or find your regional support number

THIS PAGE INTENTIONALLY LEFT BLANK



Typical Applications

The HMC327MS8G(E) is ideal for:

- Wireless Local Loop
- WiMAX & Fixed Wireless
- Access Points
- Subscriber Equipment

Features

- High Gain: 21 dB
- Saturated Power: +30 dBm @ 45% PAE
- Output P1dB: +27 dBm
- Single Supply: +5V
- Power Down Capability
- Low External Part Count
- Compact MSOP Package: 14.8 mm²

Functional Diagram

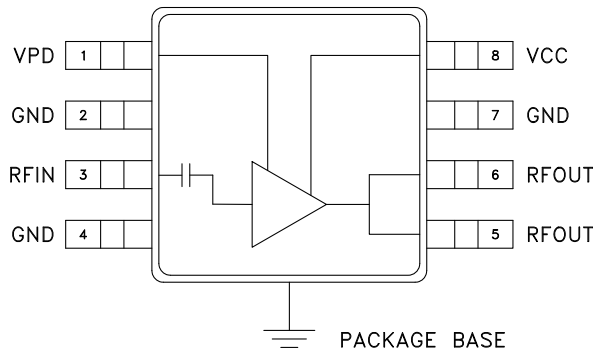

General Description

The HMC327MS8G(E) is a high efficiency GaAs InGaP Heterojunction Bipolar Transistor (HBT) MMIC power amplifier which operates between 3 and 4 GHz. The amplifier is packaged in a low cost, surface mount 8 leaded package with an exposed base for improved RF and thermal performance. With a minimum of external components, the amplifier provides 21 dB of gain, +30 dBm of saturated power at 45% PAE from a single +5V supply. Power down capability is available to conserve current consumption when the amplifier is not in use.

Electrical Specifications, $T_A = +25\text{ }^\circ\text{C}$, $V_s = 5V$, $V_{ctl} = 5V$

Parameter	Min.	Typ.	Max.	Units
Frequency Range	3 - 4			GHz
Gain	17	21	24	dB
Gain Variation Over Temperature		0.025	0.035	dB / °C
Input Return Loss		15		dB
Output Return Loss		8		dB
Output Power for 1dB Compression (P1dB)	24	27		dBm
Saturated Output Power (P _{sat})		30		dBm
Output Third Order Intercept (IP3)	36	40		dBm
Noise Figure		5		dB
Supply Current (I _{cq})	$V_{ctl}^* = 0V/5V$		0.002 / 250	mA
Control Current (I _{pd})	$V_{ctl}^* = 5V$		7	mA
Switching Speed	t _{ON} , t _{OFF}		40	ns

*See Application Circuit for proper biasing configuration.

For price, delivery, and to place orders, please contact Hittite Microwave Corporation:
 20 Alpha Road, Chelmsford, MA 01824 Phone: 978-250-3343 Fax: 978-250-3373
 Order On-line at www.hittite.com

Broadband Gain & Return Loss

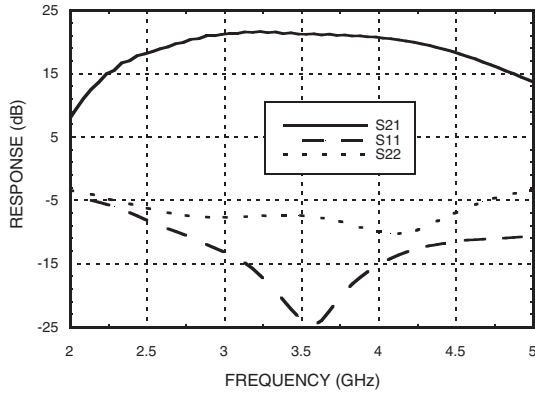

Gain vs. Temperature

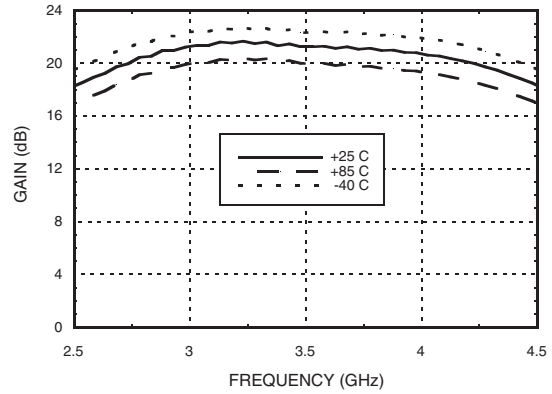

Input Return Loss vs. Temperature

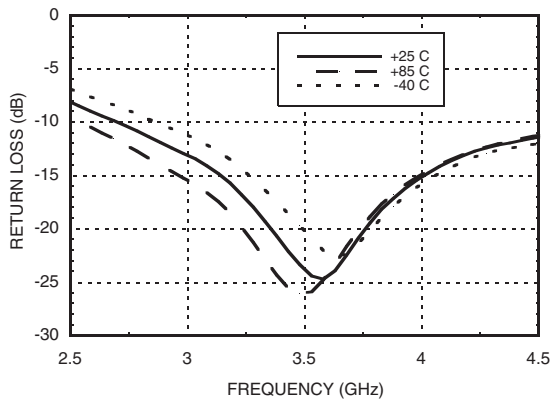

Output Return Loss vs. Temperature

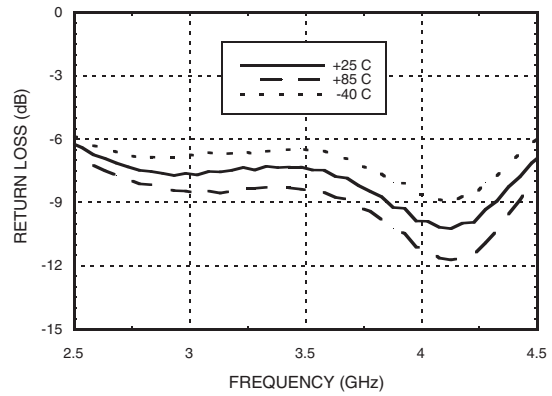

P1dB vs. Temperature

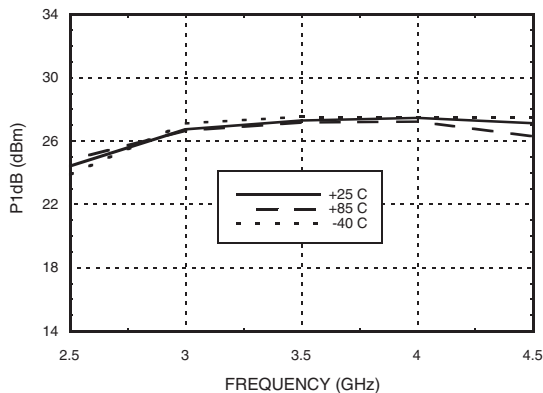

Psat vs. Temperature

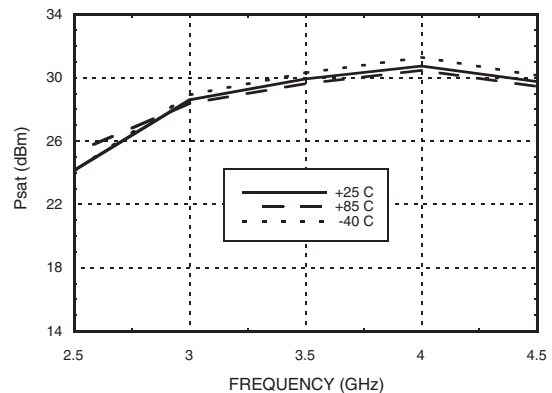

Power Compression @ 3.5 GHz

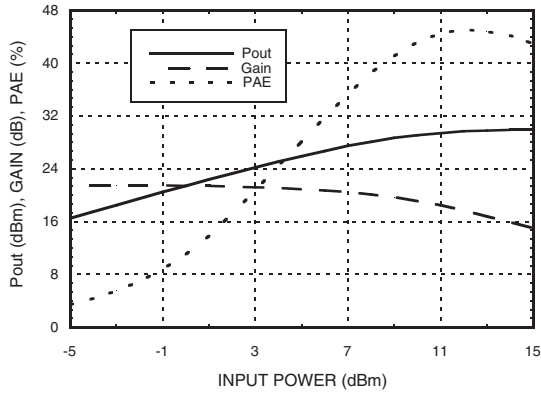

Output IP3 vs. Temperature

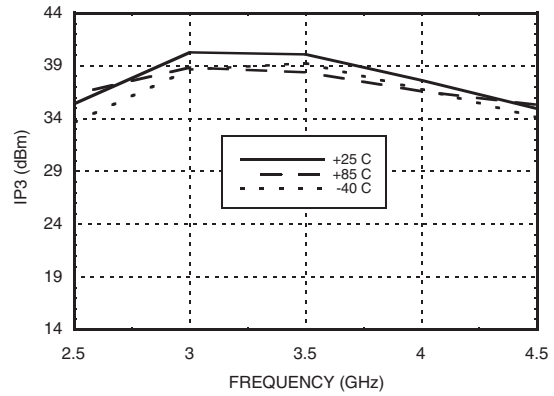

Noise Figure vs. Temperature

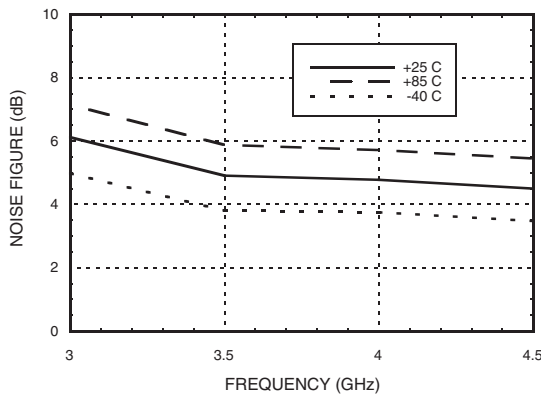

Gain & Power vs. Supply Voltage

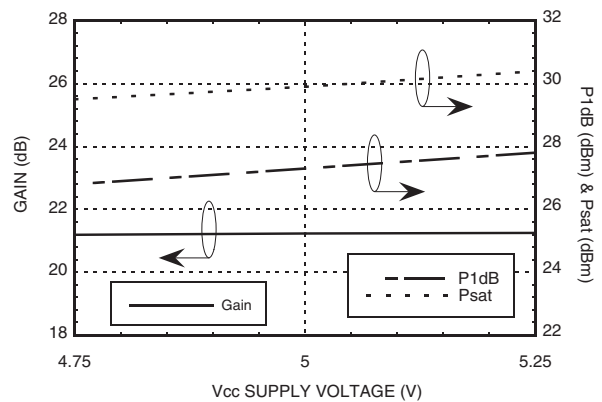

Reverse Isolation vs. Temperature

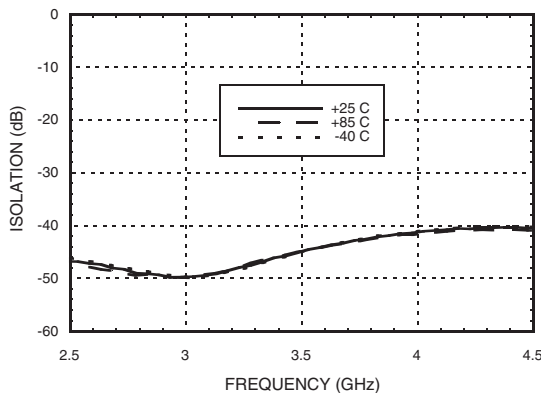

Power Down Isolation

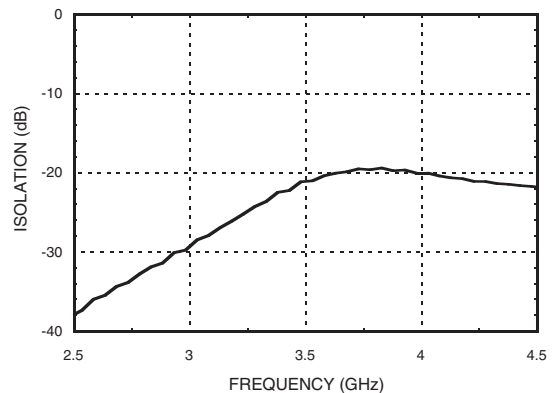

Gain, Power & Quiescent Supply Current vs. Vpd @ 3.5 GHz

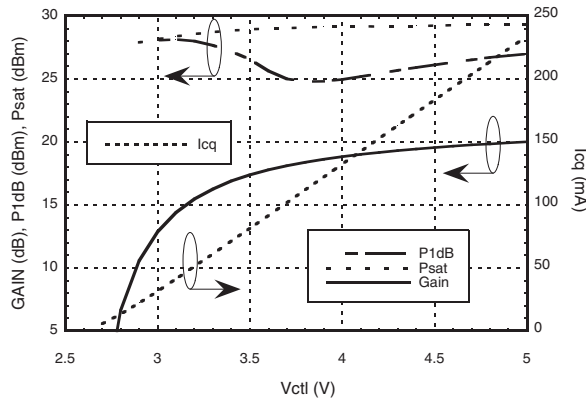

Absolute Maximum Ratings

Collector Bias Voltage (Vcc)	+5.5V
Control Voltage (Vpd)	+5.5V
RF Input Power (RFIN)(Vs = Vctl = +5V)	+16 dBm
Junction Temperature	150 °C
Continuous P _{diss} (T = 85 °C) (derate 29 mW/°C above 85 °C)	1.88 W
Thermal Resistance (junction to ground paddle)	34 °C/W
Storage Temperature	-65 to +150 °C
Operating Temperature	-40 to +85 °C



ELECTROSTATIC SENSITIVE DEVICE
OBSERVE HANDLING PRECAUTIONS

Outline Drawing

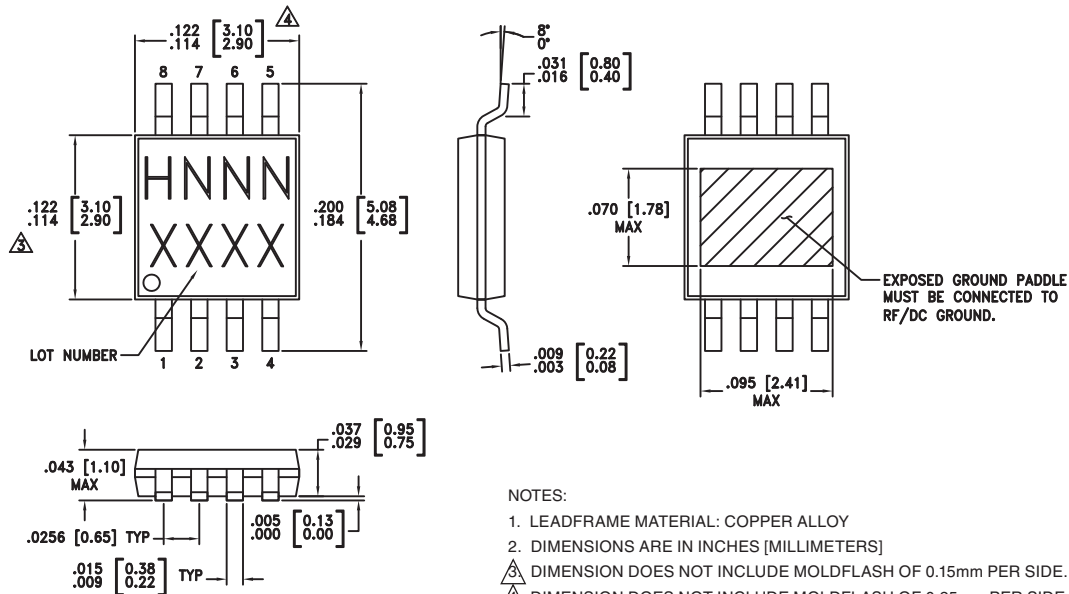

NOTES:

- LEADFRAME MATERIAL: COPPER ALLOY
- DIMENSIONS ARE IN INCHES [MILLIMETERS]
- DIMENSION DOES NOT INCLUDE MOLDFLASH OF 0.15mm PER SIDE.
- DIMENSION DOES NOT INCLUDE MOLDFLASH OF 0.25mm PER SIDE.
- ALL GROUND LEADS AND GROUND PADDLE MUST BE SOLDERED TO PCB RF GROUND.

Package Information

Part Number	Package Body Material	Lead Finish	MSL Rating	Package Marking ^[3]
HMC327MS8G	Low Stress Injection Molded Plastic	Sn/Pb Solder	MSL1 ^[1]	H327 XXXX
HMC327MS8GE	RoHS-compliant Low Stress Injection Molded Plastic	100% matte Sn	MSL1 ^[2]	H327 XXXX

[1] Max peak reflow temperature of 235 °C

[2] Max peak reflow temperature of 260 °C

[3] 4-Digit lot number XXXX

Pin Descriptions

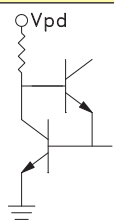
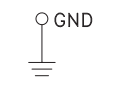
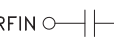
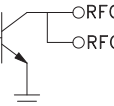
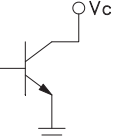
Pin Number	Function	Description	Interface Schematic
1	Vpd	Power Control Pin. For proper control bias, this pin should be connected to 5V through a series resistor of 130 Ohms. A higher voltage is not recommended. For lower idle current, this voltage can be reduced.	
2, 4, 7	GND	Ground: Backside of package has exposed metal ground paddle that must be connected to ground thru a short path. Vias under the device are required.	
3	RFIN	This pin is AC coupled and matched to 50 Ohms.	
5, 6	RFOUT	RF output and bias for the output stage. The power supply for the output device needs to be supplied to these pins.	
8	Vcc	Power supply voltage for the first amplifier stage. An external bypass capacitor of 330 pF is required. This capacitor should be placed as close to the device as possible.	

Application Circuit

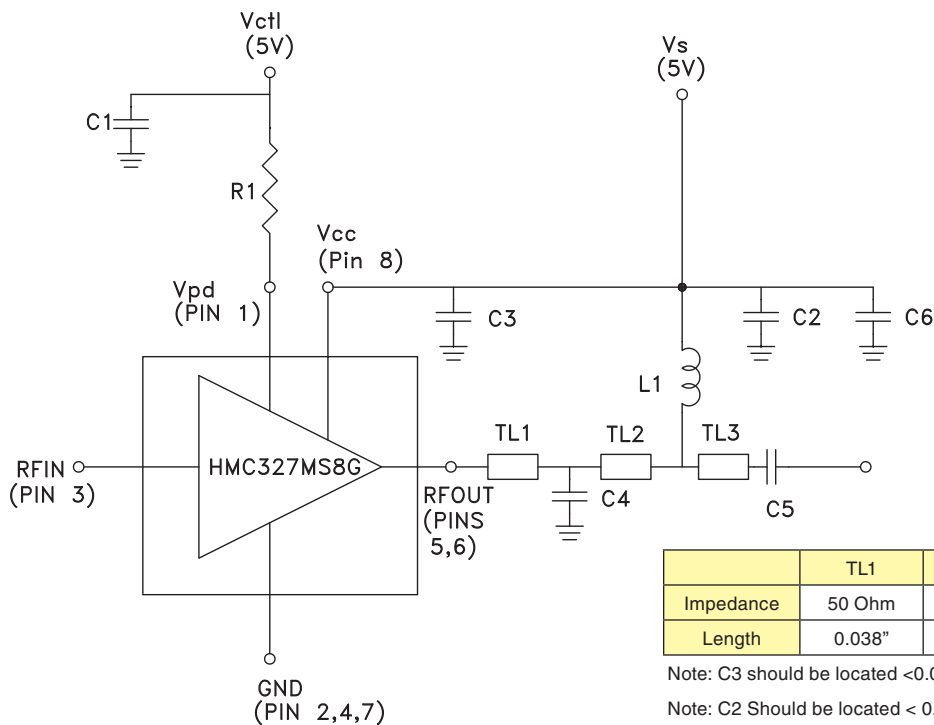

	TL1	TL2	TL3
Impedance	50 Ohm	50 Ohm	50 Ohm
Length	0.038"	0.231"	0.1"

Note: C3 should be located <0.020" from Pin 8 (Vcc)

Note: C2 Should be located < 0.020" from L1



Evaluation PCB

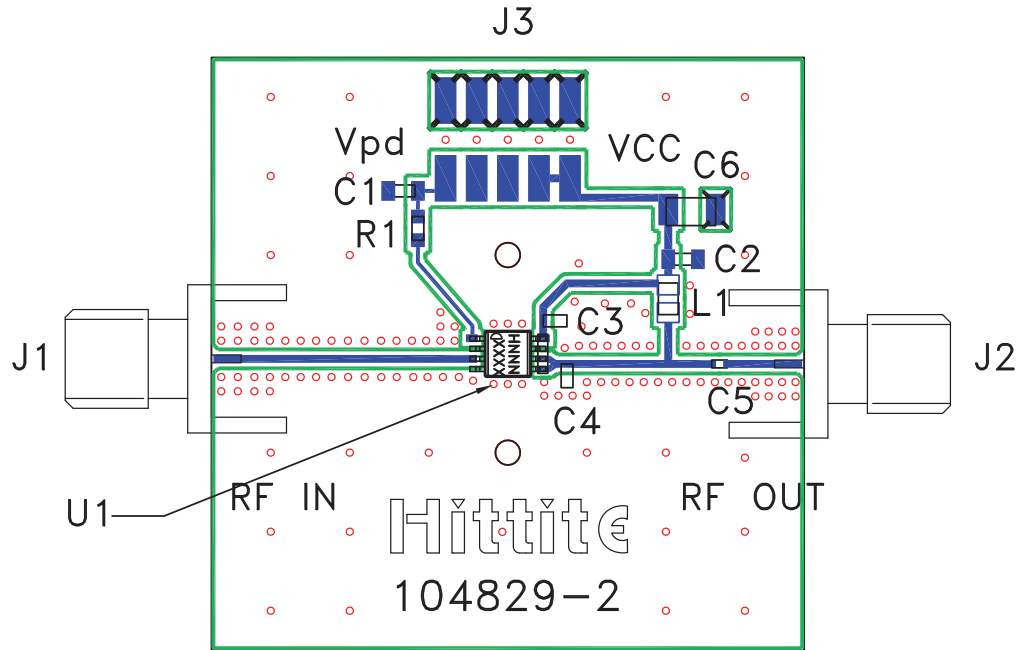

List of Materials for Evaluation PCB 104991 [1]

Item	Description
J1 - J2	PCB Mount SMA RF Connector
J3	2 mm DC Header
C1 - C3	330 pF Capacitor, 0603 Pkg.
C4	1.2 pF Capacitor, 0603 Pkg.
C5	2 pF Capacitor, 0402 Pkg.
C6	2.2 μ F Capacitor, Tantalum
L1	3 nH Inductor, 0805 Pkg.
R1	130 Ohm Resistor, 0603 Pkg.
U1	HMC327MS8G(E) Amplifier
PCB [2]	104829 Eval Board

[1] Reference this number when ordering complete evaluation PCB

[2] Circuit Board Material: Rogers 4350

The circuit board used in the application should use RF circuit design techniques. Signal lines should have 50 Ohm impedance while the package ground leads and exposed paddle should be connected directly to the ground plane similar to that shown. A sufficient number of via holes should be used to connect the top and bottom ground planes. The evaluation board should be mounted to an appropriate heat sink. The evaluation circuit board shown is available from Hittite upon request.