

# Analog Devices Welcomes Hittite Microwave Corporation

NO CONTENT ON THE ATTACHED DOCUMENT HAS CHANGED



# HMC415\* Product Page Quick Links

Last Content Update: 08/30/2016

---

## [Comparable Parts](#)

View a parametric search of comparable parts

## [Evaluation Kits](#)

- HMC415LP3 Evaluation Board

## [Documentation](#)

### **Application Notes**

- AN-1363: Meeting Biasing Requirements of Externally Biased RF/Microwave Amplifiers with Active Bias Controllers
- Broadband Biasing of Amplifiers General Application Note
- MMIC Amplifier Biasing Procedure Application Note
- Thermal Management for Surface Mount Components General Application Note

### **Data Sheet**

- HMC415 Data Sheet

## [Tools and Simulations](#)

- HMC415 S-Parameter

## [Reference Materials](#)

### **Quality Documentation**

- Package/Assembly Qualification Test Report: 16L 3x3mm QFN Package (QTR: 11003 REV: 02)
- Package/Assembly Qualification Test Report: LP2, LP2C, LP3, LP3B, LP3C, LP3D, LP3F, LP3G (QTR: 2014-0364)
- Package/Assembly Qualification Test Report: Plastic Encapsulated QFN (QTR: 05006 REV: 02)
- Semiconductor Qualification Test Report: GaAs HBT-B (QTR: 2013-00229)

## [Design Resources](#)

- HMC415 Material Declaration
- PCN-PDN Information
- Quality And Reliability
- Symbols and Footprints

## [Discussions](#)

View all HMC415 EngineerZone Discussions

## [Sample and Buy](#)

Visit the product page to see pricing options

## [Technical Support](#)

Submit a technical question or find your regional support number

---

**THIS PAGE INTENTIONALLY LEFT BLANK**



### Typical Applications

This amplifier is ideal for use as a power amplifier for 4.9 - 5.9 GHz applications:

- 802.11a WLAN
- HiperLAN WLAN
- Access Points
- UNII & ISM Radios

### Features

- Gain: 20 dB
- 34% PAE @ Psat = +26 dBm
- 3.7% EVM @ Pout = +15 dBm with 54 Mbps OFDM Signal
- Supply Voltage: +3V
- Power Down Capability
- Low External Part Count

### Functional Diagram

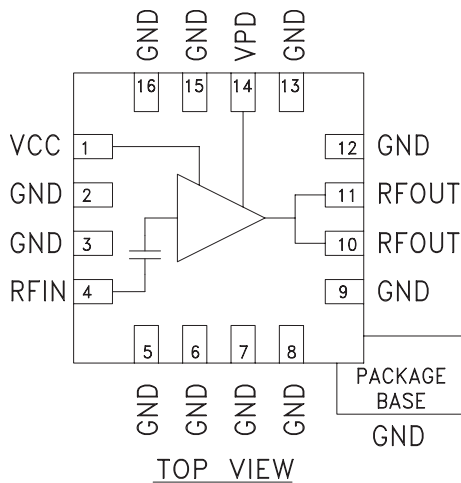

### General Description

The HMC415LP3 & HMC415LP3E are high efficiency GaAs InGaP Heterojunction Bipolar Transistor (HBT) MMIC Power amplifiers which operate between 4.9 and 5.9 GHz. The amplifier is packaged in a low cost, leadless surface mount package with an exposed base for improved RF and thermal performance. With a minimum of external components, the amplifier provides 20 dB of gain, +26 dBm of saturated power, and 34% PAE from a +3V supply voltage. Vpd can be used for full power down or RF output power/current control. For +15 dBm OFDM output power (64 QAM, 54 Mbps), the HMC415LP3 & HMC415LP3E achieve an error vector magnitude (EVM) of 3.7% meeting 802.11a linearity requirements.

### Electrical Specifications, $T_A = +25^\circ C$ , $V_s = 3V$ , $V_{pd} = 3V$

Parameter	Min.	Typ.	Max.	Min.	Typ.	Max.	Min.	Typ.	Max.	Units
Frequency Range	4.9 - 5.1			5.1 - 5.4			5.4 - 5.9			GHz
Gain	18	20		18.5	20.5		16	19		dB
Gain Variation Over Temperature		0.04	0.05		0.04	0.05		0.04	0.05	dB / °C
Input Return Loss		10			9			8		dB
Output Return Loss		10			12			8		dB
Output Power for 1dB Compression (P1dB)	Icq = 285 mA Icq = 200 mA	20	22.5 22.0	20.5	23.0 22.5		18	21.5 21.0		dBm
Saturated Output Power (Psat)		25.5			26			24		dBm
Output Third Order Intercept (IP3)		28	31	29	32		27	30		dBm
Error Vector Magnitude (54 Mbps OFDM Signal @ +15 dBm Pout)	Icq = 200 mA				3.7					%
Noise Figure		6			6			6		dB
Supply Current (Icq)	Vpd = 0V/3V		0.002 / 285		0.002 / 285			0.002 / 285		mA
Control Current (Ipd)	Vpd = 3V		7		7			7		mA
Switching Speed	tOn, tOff		45		45			45		ns

For price, delivery, and to place orders, please contact Hittite Microwave Corporation:  
20 Alpha Road, Chelmsford, MA 01824 Phone: 978-250-3343 Fax: 978-250-3373  
Order On-line at [www.hittite.com](http://www.hittite.com)



**Broadband Gain & Return Loss**

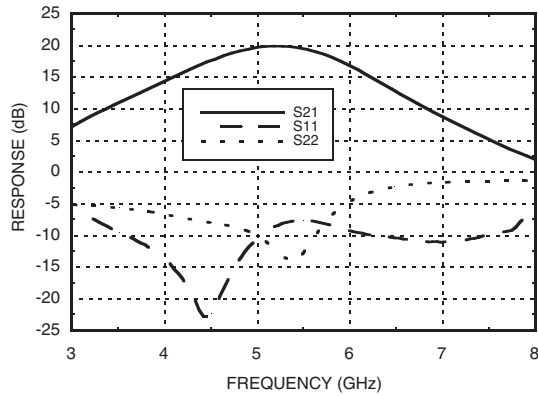

**Gain vs. Temperature**

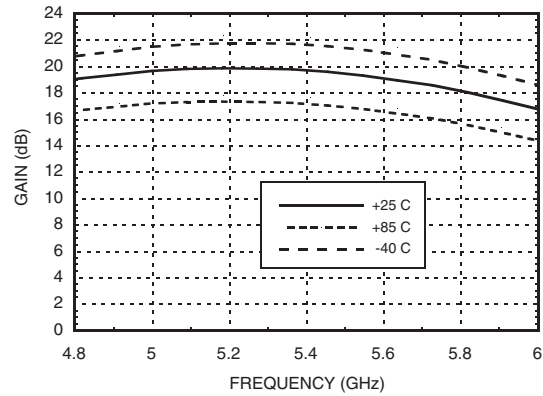

**Input Return Loss vs. Temperature**

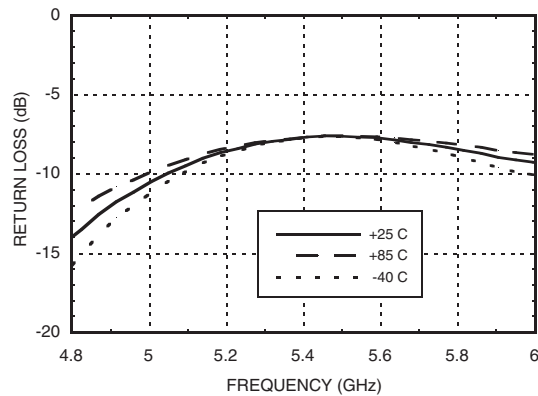

**Output Return Loss vs. Temperature**

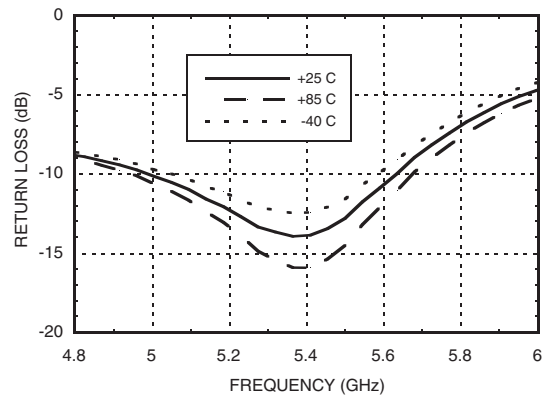

**P1dB vs. Temperature**

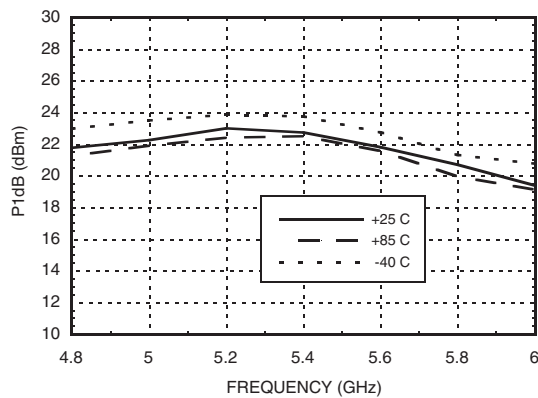

**Psat vs. Temperature**

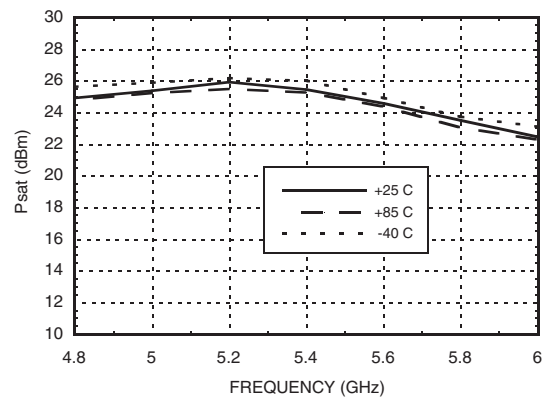

11

LINEAR & POWER AMPLIFIERS - SMT

**Power Compression @ 5.2 GHz**

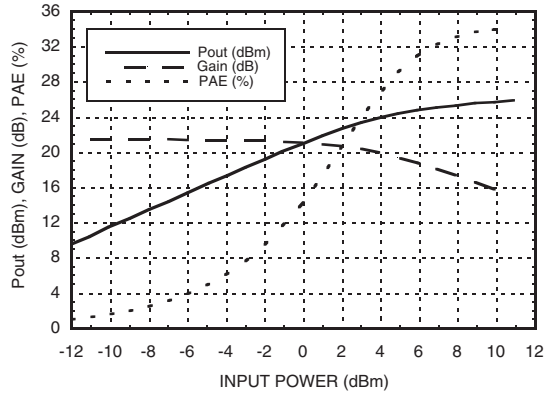

**Output IP3 vs. Temperature**

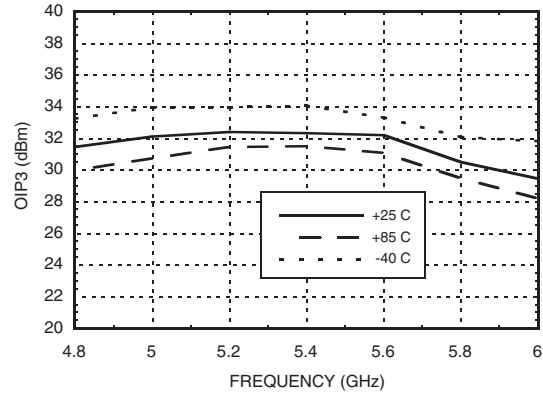

**Noise Figure vs. Temperature**

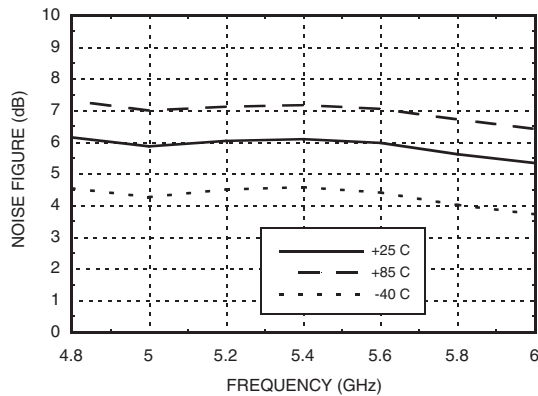

**Gain & Power vs. Supply Voltage**

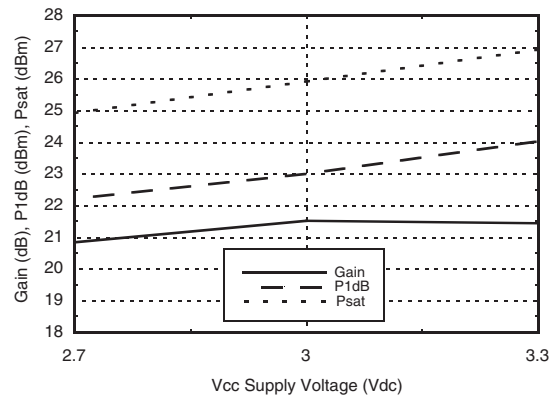

**Reverse Isolation vs. Temperature**

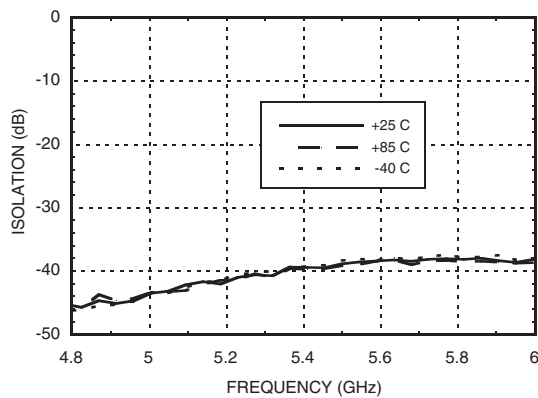

**Power Down Isolation vs. Temperature**

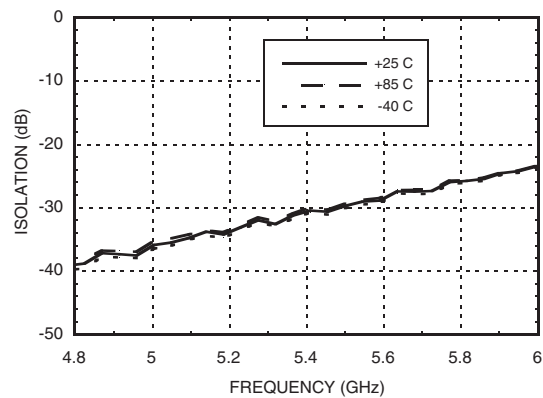



**EVM vs. Supply Current,  
F = 5.2 GHz**

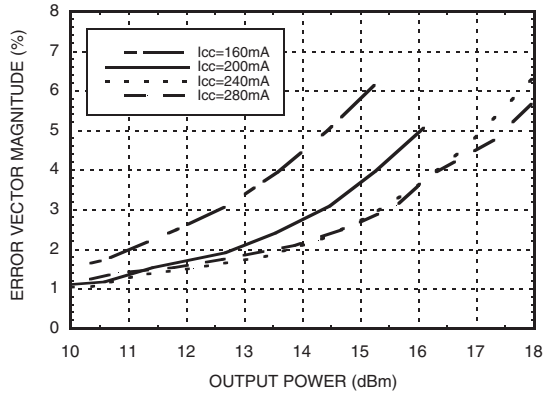

**EVM vs. Temperature,  
Icc = 240 mA, F = 5.2 GHz**

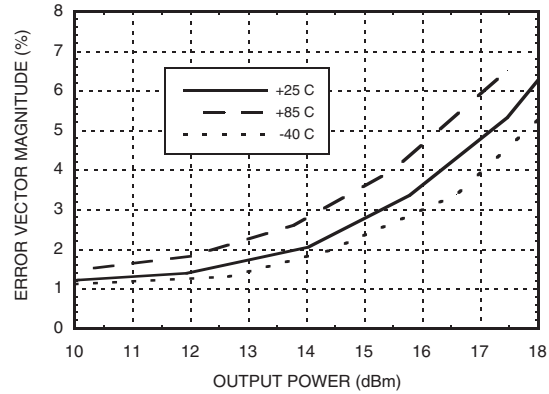

**Gain, Power & Quiescent  
Supply Current vs. Vpd @ 5.2 GHz**

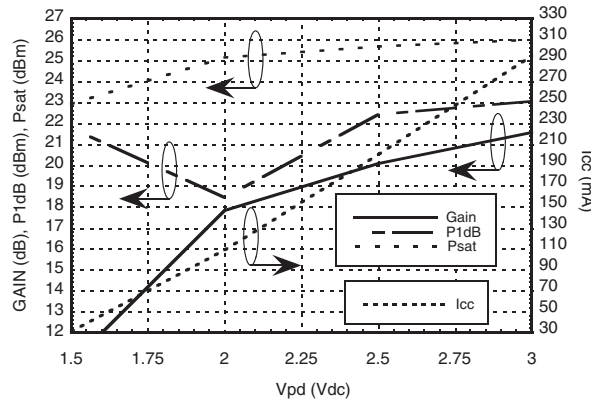

### Absolute Maximum Ratings

Collector Bias Voltage (Vcc)	+5Vdc
Control Voltage (Vpd)	+3.5 Vdc
RF Input Power (RFIN)(Vs = Vpd = +3.0 Vdc)	+13 dBm
Junction Temperature	150 °C
Continuous P <sub>diss</sub> (T = 85 °C) (derate 17 mW/°C above 85 °C)	1.105 W
Thermal Resistance (junction to ground paddle)	59 °C/W
Storage Temperature	-65 to +150 °C
Operating Temperature	-40 to +85 °C



ELECTROSTATIC SENSITIVE DEVICE  
OBSERVE HANDLING PRECAUTIONS

### Outline Drawing

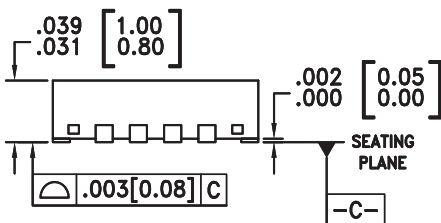
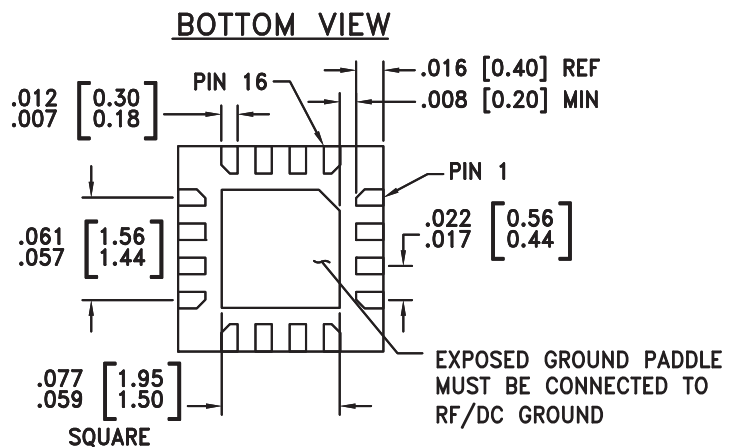
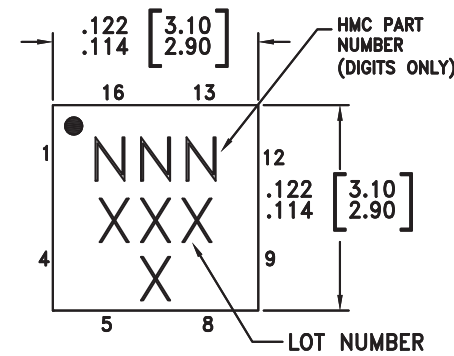

#### NOTES:

1. LEADFRAME MATERIAL: COPPER ALLOY
2. DIMENSIONS ARE IN INCHES [MILLIMETERS]
3. LEAD SPACING TOLERANCE IS NON-CUMULATIVE
4. PAD BURR LENGTH SHALL BE 0.15mm MAXIMUM.  
PAD BURR HEIGHT SHALL BE 0.05mm MAXIMUM.
5. PACKAGE WARP SHALL NOT EXCEED 0.05mm.
6. ALL GROUND LEADS AND GROUND PADDLE MUST BE SOLDERED TO PCB RF GROUND.
7. REFER TO HITTITE APPLICATION NOTE FOR SUGGESTED LAND PATTERN.

### Package Information

Part Number	Package Body Material	Lead Finish	MSL Rating	Package Marking <sup>[3]</sup>
HMC415LP3	Low Stress Injection Molded Plastic	Sn/Pb Solder	MSL1 <sup>[1]</sup>	415 XXXX
HMC415LP3E	RoHS-compliant Low Stress Injection Molded Plastic	100% matte Sn	MSL1 <sup>[2]</sup>	415 XXXX

[1] Max peak reflow temperature of 235 °C

[2] Max peak reflow temperature of 260 °C

[3] 4-Digit lot number XXXX

For price, delivery, and to place orders, please contact Hittite Microwave Corporation:  
20 Alpha Road, Chelmsford, MA 01824 Phone: 978-250-3343 Fax: 978-250-3373  
Order On-line at [www.hittite.com](http://www.hittite.com)

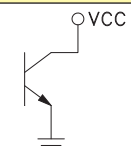
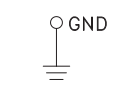
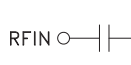
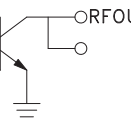
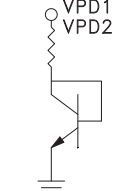

**Pin Descriptions**

Pin Number	Function	Description	Interface Schematic
1	Vcc	Power supply voltage for the first amplifier stage. An external bypass capacitor of 330 pF is required as shown in the application schematic.	
2, 3, 5, 6, 7, 8, 9, 12, 13, 15, 16	GND	Ground: Backside of package has exposed metal ground slug that must be connected to ground thru a short path. Vias under the device are required.	
4	RFIN	This pin is AC coupled and matched to 50 Ohms from 5.0 to 6.0 GHz.	
10, 11	RFOUT	RF output and DC bias for the output stage.	
14	Vpd	Power control pin. For maximum power, this pin should be connected to 3.0V. A higher voltage is not recommended. For lower idle current, this voltage can be reduced.	

**Evaluation PCB**

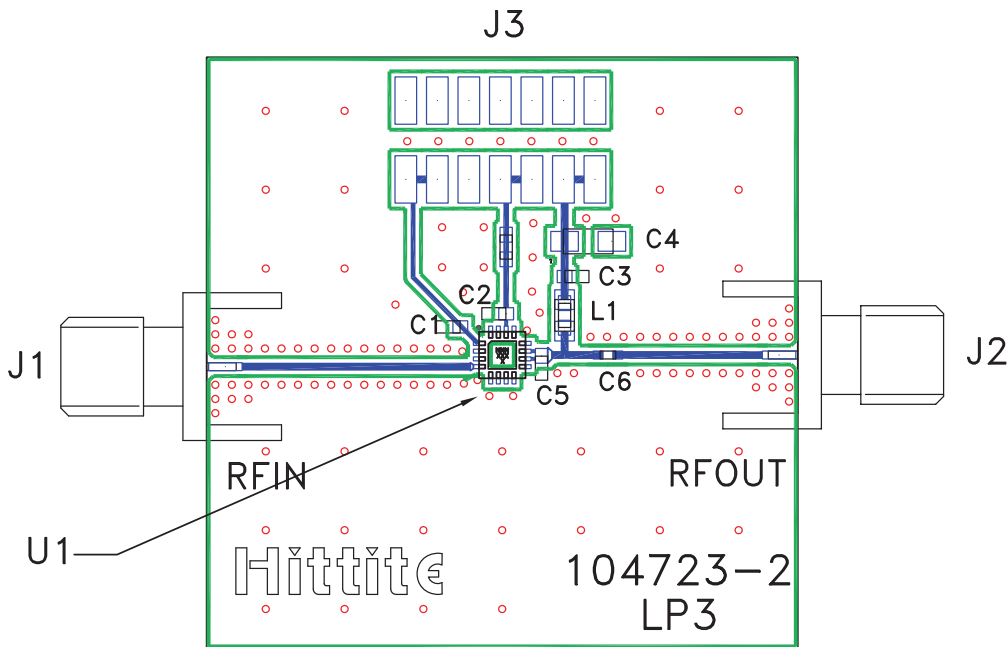

**List of Materials for Evaluation PCB 105173 [1]**

Item	Description
J1 - J2	PCB Mount SMA RF Connector
J3	2 mm DC Header
C1 - C3	330 pF Capacitor, 0603 Pkg.
C4	2.2 $\mu$ F Capacitor, Tantalum
C5	0.5 pF Capacitor, 0603 Pkg.
C6	7.0 pF Capacitor, 0402 Pkg.
L1	3.0 nH Inductor, 0805 Pkg.
U1	HMC415LP3 / HMC415LP3E Amplifier
PCB [2]	104723 Eval Board

[1] Reference this number when ordering complete evaluation PCB

[2] Circuit Board Material: Rogers 4350

The circuit board used in the final application should use RF circuit design techniques. Signal lines should have 50 ohm impedance while the package ground leads and exposed paddle should be connected directly to the ground plane similar to that shown. A sufficient number of via holes should be used to connect the top and bottom ground planes. The evaluation board should be mounted to an appropriate heat sink. The evaluation circuit board shown is available from Hittite upon request.

### Application Circuit

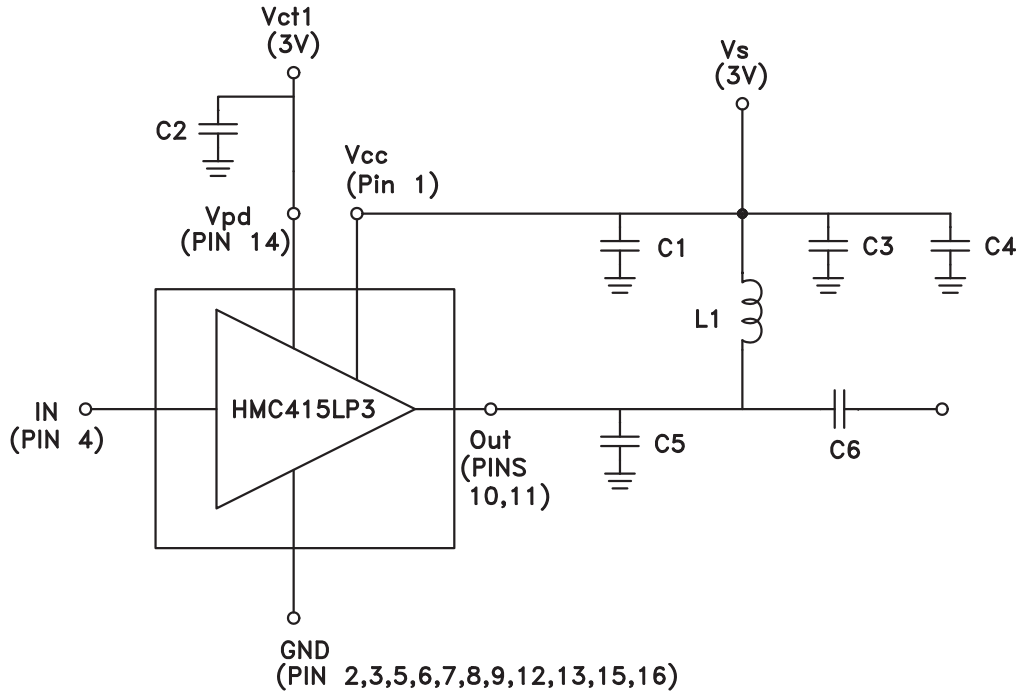

Recommended Component Values	
L1	3.0 nH
C1, C2, C3	330 pF
C4	2.2 $\mu$ F
C5	0.5 pF
C6	7.0 pF

Note 1: C1 should be located < 0.1" (2.54mm) from Pin 1 (Vcc)

Note 2: C3 should be located < 0.1" (2.54mm) from L1.