

Analog Devices Welcomes Hittite Microwave Corporation

NO CONTENT ON THE ATTACHED DOCUMENT HAS CHANGED



HMC510* Product Page Quick Links

Last Content Update: 08/30/2016

Comparable Parts

View a parametric search of comparable parts

Evaluation Kits

- HMC510LP5 Evaluation Board.

Documentation

Data Sheet

- HMC510 Data Sheet

Reference Materials

Quality Documentation

- Package/Assembly Qualification Test Report: 32L 5x5mm QFN Package (QTR: 10009 REV: 05)
- Package/Assembly Qualification Test Report: LP3, LP4, LP5 & LP5G (QTR: 2014-00145)
- Package/Assembly Qualification Test Report: Plastic Encapsulated QFN (QTR: 05006 REV: 02)
- Semiconductor Qualification Test Report: GaAs HBT-A (QTR: 2013-00228)

Technical Articles

- High Performance SiGe PLLs Pair with Low Phase Noise GaAs VCOs for Microwave Radio

Design Resources

- HMC510 Material Declaration
- PCN-PDN Information
- Quality And Reliability
- Symbols and Footprints

Discussions

View all HMC510 EngineerZone Discussions

Sample and Buy

Visit the product page to see pricing options

Technical Support

Submit a technical question or find your regional support number

* This page was dynamically generated by Analog Devices, Inc. and inserted into this data sheet. Note: Dynamic changes to the content on this page does not constitute a change to the revision number of the product data sheet. This content may be frequently modified.

THIS PAGE INTENTIONALLY LEFT BLANK



HMC510LP5/510LP5E

MMIC VCO WITH HALF FREQUENCY OUTPUT 8.45 - 9.55 GHz

Typical Applications

Low noise MMIC VCO w/Half Frequency, Divide-by-4 Outputs for:

- Point to Point/Multipoint Radio
- Test Equipment & Industrial Controls
- SATCOM
- Military End-Use

Features

- Dual Output: $F_o = 8.45 - 9.55$ GHz
 $F_o/2 = 4.225 - 4.775$ GHz
- Pout: +13 dBm
- Phase Noise: -116 dBc/Hz @100 kHz Typ.
- No External Resonator Needed
- 32 Lead 5x5mm SMT Package: 25mm²

Functional Diagram

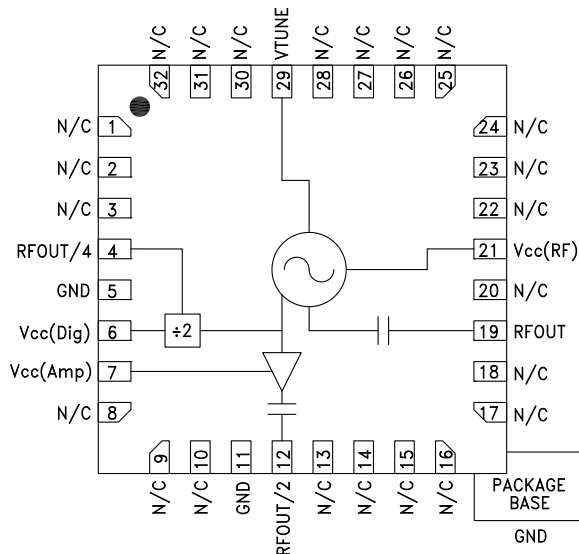

General Description

The HMC510LP5 & HMC510LP5E are GaAs InGaP Heterojunction Bipolar Transistor (HBT) MMIC VCOs. The HMC510LP5 & HMC510LP5E integrate resonators, negative resistance devices, varactor diodes and feature half frequency and divide-by-4 outputs. The VCO's phase noise performance is excellent over temperature, shock, and process due to the oscillator's monolithic structure. Power output is +13 dBm typical from a +5V supply voltage. The prescaler and RF/2 functions can be disabled to conserve current if not required. The voltage controlled oscillator is packaged in a leadless QFN 5x5 mm surface mount package, and requires no external matching components.

Electrical Specifications, $T_A = +25^\circ C$, $V_{cc} (Dig)$, $V_{cc} (Amp)$, $V_{cc} (RF) = +5V$

| Parameter | Min. | Typ. | Max. | Units | |
|---------------------------------------------------------|------------------------------------------|------------------------------|------------------|-------------------|----|
| Frequency Range | F_o $F_o/2$ | 8.45 - 9.55 4.225 - 4.775 | | GHz GHz | |
| Power Output | RFOUT RFOUT/2 RFOUT/4 | +10 +8 -8 | +15 +14 -4 | dBm dBm dBm | |
| SSB Phase Noise @ 100 kHz Offset, Vtune= +5V @ RFOUT | | -116 | | dBc/Hz | |
| Tune Voltage | Vtune | 2 | 13 | V | |
| Supply Current | $I_{cc}(Dig) + I_{cc}(Amp) + I_{cc}(RF)$ | 270 | 315 | 360 | mA |
| Tune Port Leakage Current (Vtune= 13V) | | | 10 | μA | |
| Output Return Loss | | 2 | | dB | |
| Harmonics/Subharmonics | 1/2 2nd 3rd | | 40 15 40 | dBc dBc dBc | |
| Pulling (into a 2.0:1 VSWR) | | 6 | | MHz pp | |
| Pushing @ Vtune= 5V | | 20 | | MHz/V | |
| Frequency Drift Rate | | 0.8 | | MHz/ $^\circ C$ | |

Frequency vs. Tuning Voltage, Vcc = +5V

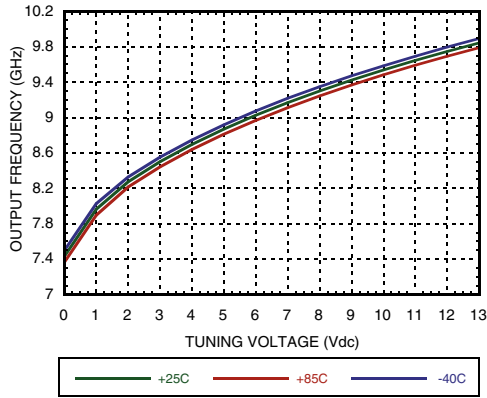

Frequency vs. Tuning Voltage, T = 25°C

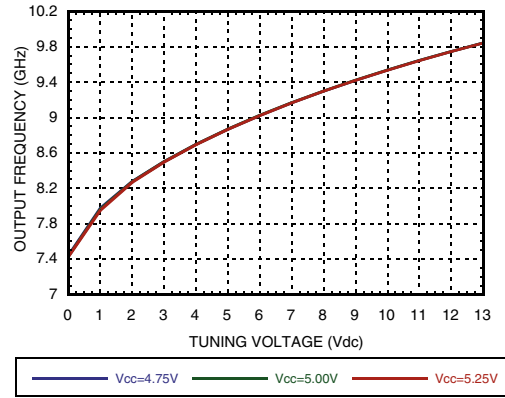

Sensitivity vs. Tuning Voltage, Vcc = +5V

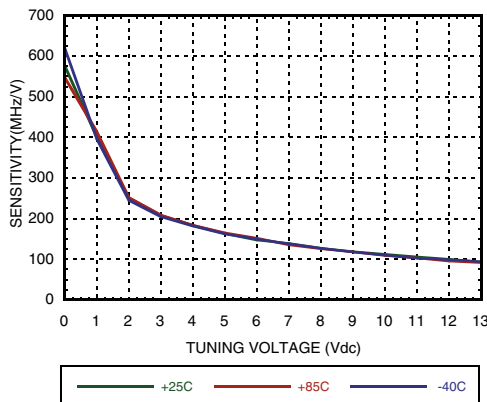

Output Power vs. Tuning Voltage, Vcc = +5V

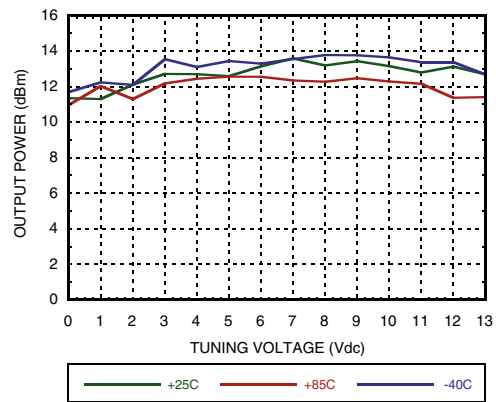

SSB Phase Noise vs. Tuning Voltage

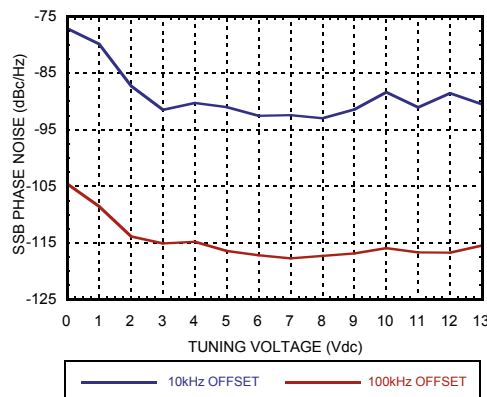

SSB Phase Noise @ Vtune = +5V

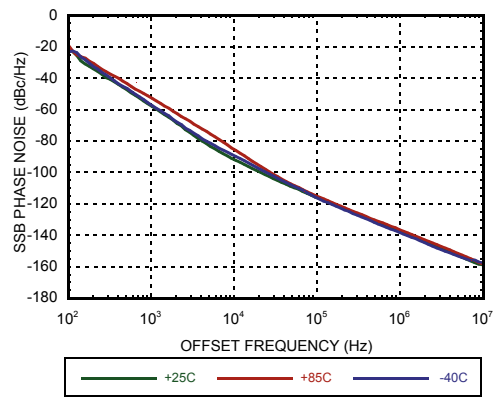



MMIC VCO WITH HALF FREQUENCY OUTPUT 8.45 - 9.55 GHz

RFOUT/2 Frequency vs. Tuning Voltage, Vcc = +5V

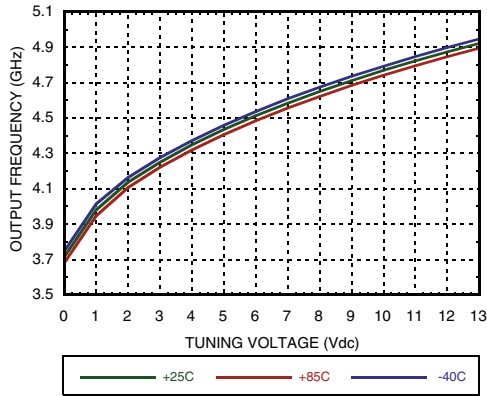

RFOUT/2 Output Power vs. Tuning Voltage, Vcc = +5V

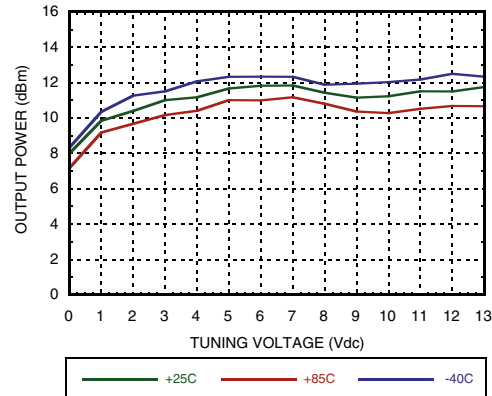

Divide-by-4 Frequency vs. Tuning Voltage, Vcc = +5V

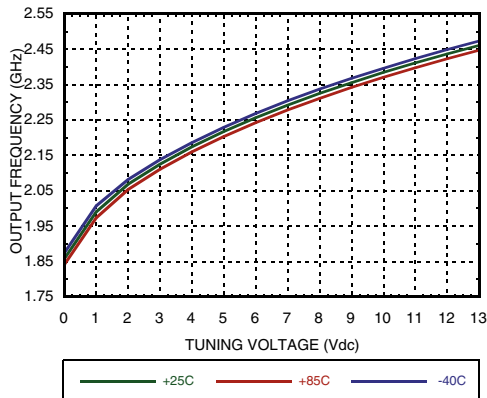

Divide-by-4 Output Power vs. Tuning Voltage, Vcc = +5V

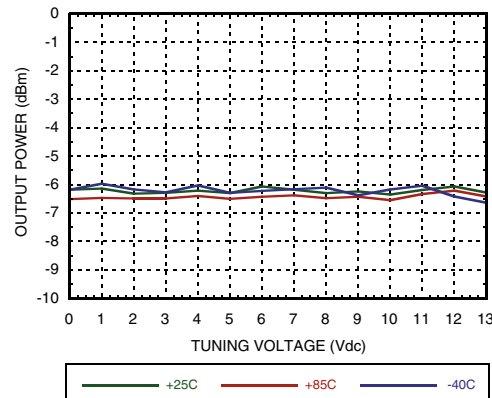

Absolute Maximum Ratings

| | |
|-----------------------------|----------------|
| Vcc(Dig), Vcc(Amp), Vcc(RF) | +5.5 Vdc |
| Vtune | 0 to +15V |
| Storage Temperature | -65 to +150 °C |
| ESD Sensitivity (HBM) | Class 1A |

Reliability Information

| | |
|------------------------------------------------------|---------------|
| Junction Temperature To Maintain 1 Million Hour MTTF | 135 °C |
| Nominal Junction Temperature (T=85 °C) | 121.2 °C |
| Thermal Resistance (junction to ground paddle) | 23 °C/W |
| Operating Temperature | -40 to +85 °C |



**ELECTROSTATIC SENSITIVE DEVICE
OBSERVE HANDLING PRECAUTIONS**

Typical Supply Current vs. Vcc

| Vcc (V) | Icc (mA) |
|---------|----------|
| 4.75 | 290 |
| 5.00 | 315 |
| 5.25 | 340 |

Note: VCO will operate over full voltage range shown above.

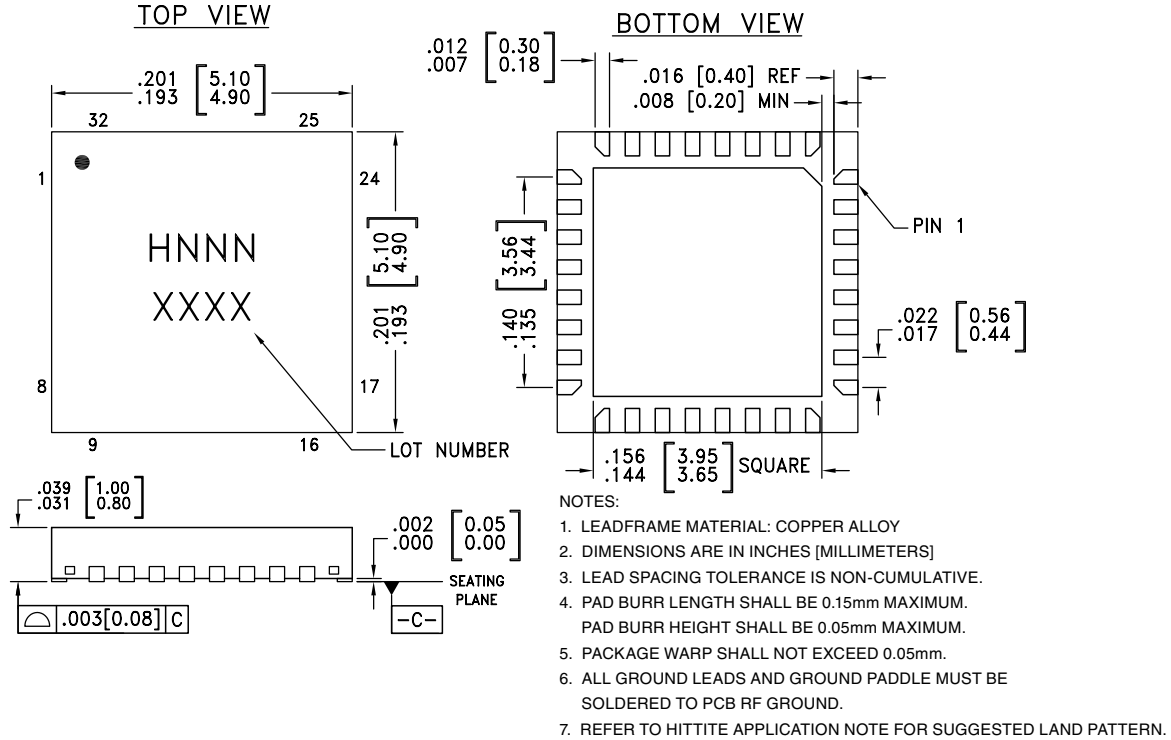
Outline Drawing

Package Information

| Part Number | Package Body Material | Lead Finish | MSL Rating | Package Marking ^[3] |
|-------------|----------------------------------------------------|---------------|---------------------|--------------------------------|
| HMC510LP5 | Low Stress Injection Molded Plastic | Sn/Pb Solder | MSL3 ^[1] | H510 XXXX |
| HMC510LP5E | RoHS-compliant Low Stress Injection Molded Plastic | 100% matte Sn | MSL3 ^[2] | H510 XXXX |

[1] Max peak reflow temperature of 235 °C

[2] Max peak reflow temperature of 260 °C

[3] 4-Digit lot number XXXX

Pin Descriptions

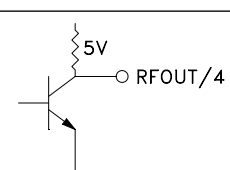
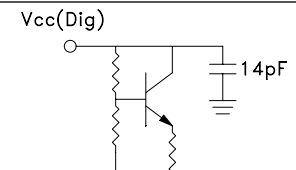
| Pin Number | Function | Description | Interface Schematic |
|------------------------------------------|-----------|-----------------------------------------------------------------------------------------------------------------------------------|---------------------------------------------------------------------------------------|
| 1-3, 8-10, 13-18, 20, 22-28, 30-32 | N/C | No Connection. These pins may be connected to RF/DC ground. Performance will not be affected. | |
| 4 | RFOUT/4 | Divide-by-4 output. DC block required. |  |
| 6 | Vcc (Dig) | Supply voltage for prescaler. If prescaler is not required, this pin may be left open to conserve approximately 65 mA of current. |  |



MMIC VCO WITH HALF FREQUENCY OUTPUT 8.45 - 9.55 GHz

Pin Descriptions

| Pin Number | Function | Description | Interface Schematic |
|---------------|-----------|---------------------------------------------------------------------------------------------------------------------------------------------------------------------------------------|---------------------|
| 7 | Vcc (Amp) | Supply voltage, for RFOUT/2 output. If RFOUT/2 is not required, this pin may be left open to conserve approximately 30 mA of current. | |
| 12 | RFOUT/2 | Half frequency output (AC coupled). | |
| 19 | RF OUT | RF output (AC coupled). | |
| 21 | Vcc (RF) | Supply Voltage, +5V | |
| 29 | VTUNE | Control voltage and modulation input. Modulation bandwidth dependent on drive source impedance. See "Determining the FM Bandwidth of a Wideband Varactor Tuned VCO" application note. | |
| 5, 11, Paddle | GND | Package bottom has an exposed metal paddle that must be connected to RF/DC ground. | |

Typical Application Circuit

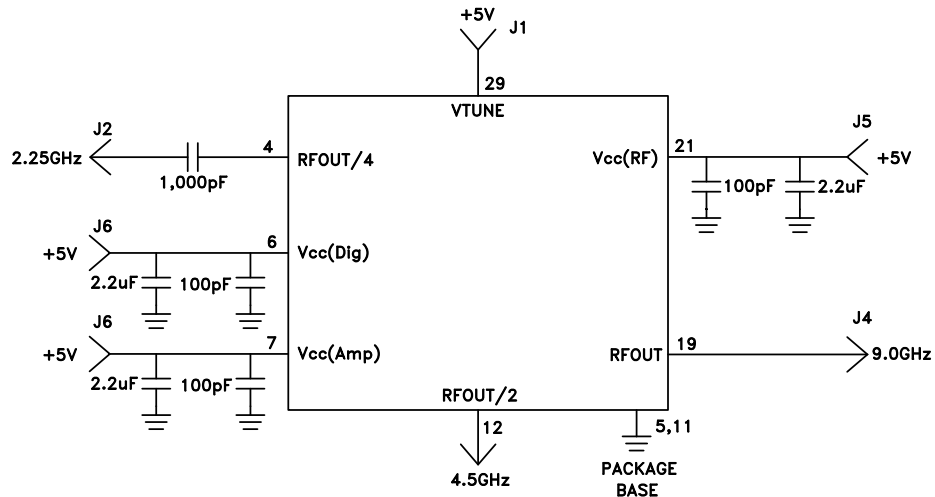

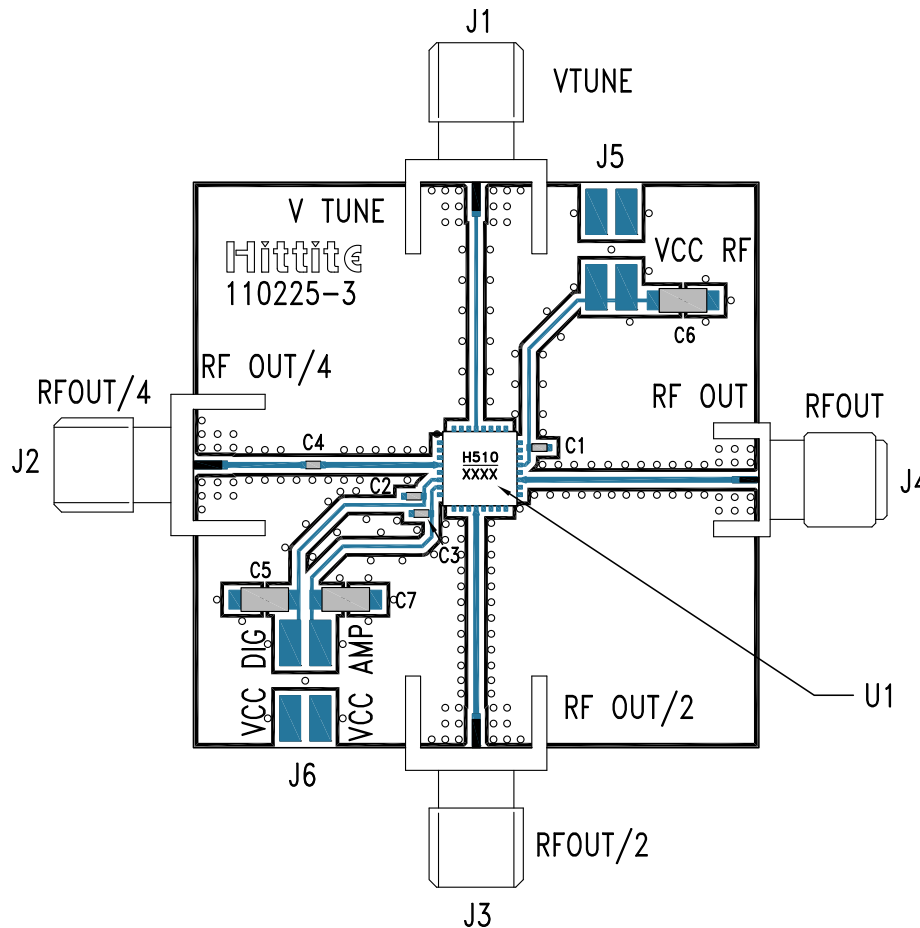
Evaluation PCB

List of Materials for Evaluation PCB 110227 [1]

| Item | Description |
|---------|--------------------------------|
| J1 - J4 | PCB Mount SMA RF Connector |
| J5 - J6 | 2 mm DC Header |
| C1 - C3 | 100 pF Capacitor, 0402 Pkg. |
| C4 | 1,000 pF Capacitor, 0402 Pkg. |
| C5 - C7 | 2.2 μ F Tantalum Capacitor |
| U1 | HMC510LP5 / HMC510LP5E VCO |
| PCB [2] | 110225 Eval Board |

[1] Reference this number when ordering complete evaluation PCB

[2] Circuit Board Material: Rogers 4350

The circuit board used in the application should use RF circuit design techniques. Signal lines should have 50 Ohm impedance while the package ground leads and backside ground paddle should be connected directly to the ground plane similar to that shown. A sufficient number of via holes should be used to connect the top and bottom ground planes. The evaluation circuit board shown is available from Hittite upon request.