

Specification	
Part Number:	MCT070Z0TW1W800480LML
Version:	1
Date:	26/05/2016
Revision	
0	16/05/26 First issue

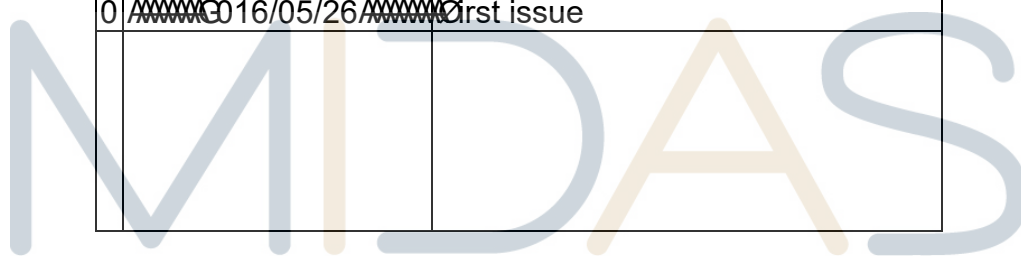

Display Size	7.0"
Resolution	800 x 480
VGA Size	WVGA
Orientation	Landscape
Appearance	RGB
Logic Voltage	3.3V
Interface	RGB
Brightness	250 cd/m ²
Touchscreen	Resistive
Module Size W x H x D	165.00 x 100.00 x 7.00 mm
Operating Temperature	-20°C ~ +70°C
Pin Out	40 – Way



Contents

1.Module Classification Information

2.Summary

3.General Specification

4.Interface

5.Contour Drawing

6.Block Diagram

7.Absolute Maximum Ratings

8.Electrical Characteristics

9.DC Characteristics

10.AC Characteristics

11.Optical Characteristics

12.Reliability

13.Touch Panel Information

14.Other

MIDAS

design • manufacture • supply



Midas Active Matrix Display Part Number System

MC T 057 A 6 * W 320240 L M L * *
1 2 3 4 5 6 7 8 9 10 11 12 13

- 1 = **MC:** Midas Components
- 2 = **T:** TFTA: Active Matrix OLED
- 3 = **Size**
- 4 = **Series**
- 5 = **Viewing Angle:** 6: 6 O'clock 12: 12 O'clock O: All Round Viewing Angle
- 6 = **Blank:** No Touch **T:** Resistive Touchscreen **C:** Capacitive Touchscreen
- 7 = **Operating Temp Range:** **S:** 0+50Deg C **B:** -20+60Deg C
W: -20+70Deg C **E:** -30+85Deg C
X: -30+80Deg C
- 8 = **No of Pixels**
- 9 = **Orientation:** **P:** Portrait **L:** Landscape
- 10 = **Mode:** **R:** Reflective **M:** Transmissive **T:** Transflective
S: Sunlight Readable (Transmissive) **W:** White on Black (Monochrome)
- 11 = **Backlight:** **Blank:** None **L:** LED **C:** CCFL
- 12 = **Blank:** No Module/board **C:** Controller board module (E-Tech)
- 13 = **Blank:** None **OB:** Optically Bonded **IPS:** In-plane switching



2.Summary

This technical specification applies to 7.0' color TFT-LCD panel. The 7.0' color TFT-LCD panel is designed for camcorder, digital camera application and other electronic products which require high quality flat panel displays. This module follows RoHS.



3. General Specifications

- Size: 7.0 inch
- Dot Matrix: 800 x RGBx480(TFT)
- Module dimension: 165.0(W) x 100(H) x 7.0(D) mm
- Active area: 154.08 x 85.92 mm
- Dot pitch: 0.0642 x 0.179 mm
- LCD type: TFT, Normally White, Transmissive
- View Direction: 12 o'clock
- Gray Scale Inversion Direction: 6 o'clock
- Backlight Type: LED, Normally White
- With /Without TP: With RTP
- Surface: Anti-Glare

*Color tone slight changed by temperature and driving voltage.

MIDAS
design • manufacture • supply



4.Interface

4.1. LCM PIN Definition

Pin	Symbol	Function	Remark
1	VLED-	Backlight ground	
2	VLED+	Power supply for backlight	
3	GND	Power ground	
4	VCC	Power for Digital Circuit	
5	R0	Red data(LSB)	Note 1
6	R1	Red data	Note 1
7	R2	Red data	
8	R3	Red data	
9	R4	Red data	
10	R5	Red data	
11	R6	Red data	
12	R7	Red data(MSB)	
13	G0	Green data(LSB)	Note 1
14	G1	Green data	Note 1
15	G2	Green data	
16	G3	Green data	
17	G4	Green data	
18	G5	Green data	
19	G6	Green data	
20	G7	Green data(MSB)	
21	B0	Blue data(LSB)	Note 1
22	B1	Blue data	Note 1
23	B2	Blue data	
24	B3	Blue data	
25	B4	Blue data	
26	B5	Blue data	
27	B6	Blue data	
28	B7	Blue data(MSB)	
29	GND	Power Ground	
30	CLK	Sample clock	Note 2
31	R/L	Right /Left selection	Note 3,4
32	Hsync	Horizontal Sync Input	
33	Vsync	Vertical Sync Input	
34	NC	No connection	
35	U/D	Up/down selection	Note 3,4
36	RESET	Global reset pin.	
37	NC	No connection	
38	NC	No connection	
39	NC	No connection	
40	NC	No connection	

Note 1: When input 18 bits RGB data, the two low bits of R,G and B data must be grounded.

Note 2: Data shall be latched at the falling edge of CLK.

Note 3: Selection of scanning mode

Setting of scan control		Scanning direction
U/D	R/L	
GND	VCC	Up to down, left to right
VCC	GND	Down to up, right to left
GND	GND	Up to down, right to left
VCC	VCC	Down to up, left to right

Note 4: Definition of scanning direction.

Refer to the figure as below:

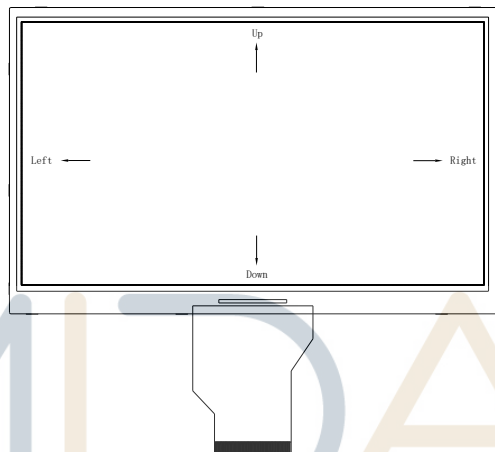

Note 5: Global reset pin. Active low to enter reset state . Suggest to connect with an RC reset circuit for stability. Normally pull high.

Note 6: Dithering function enable control, normally pull high.

When DITHB="1", Disable internal dithering function,

When DITHB="0", Enable internal dithering function,

design • manufacture • supply



5. Contour Drawing

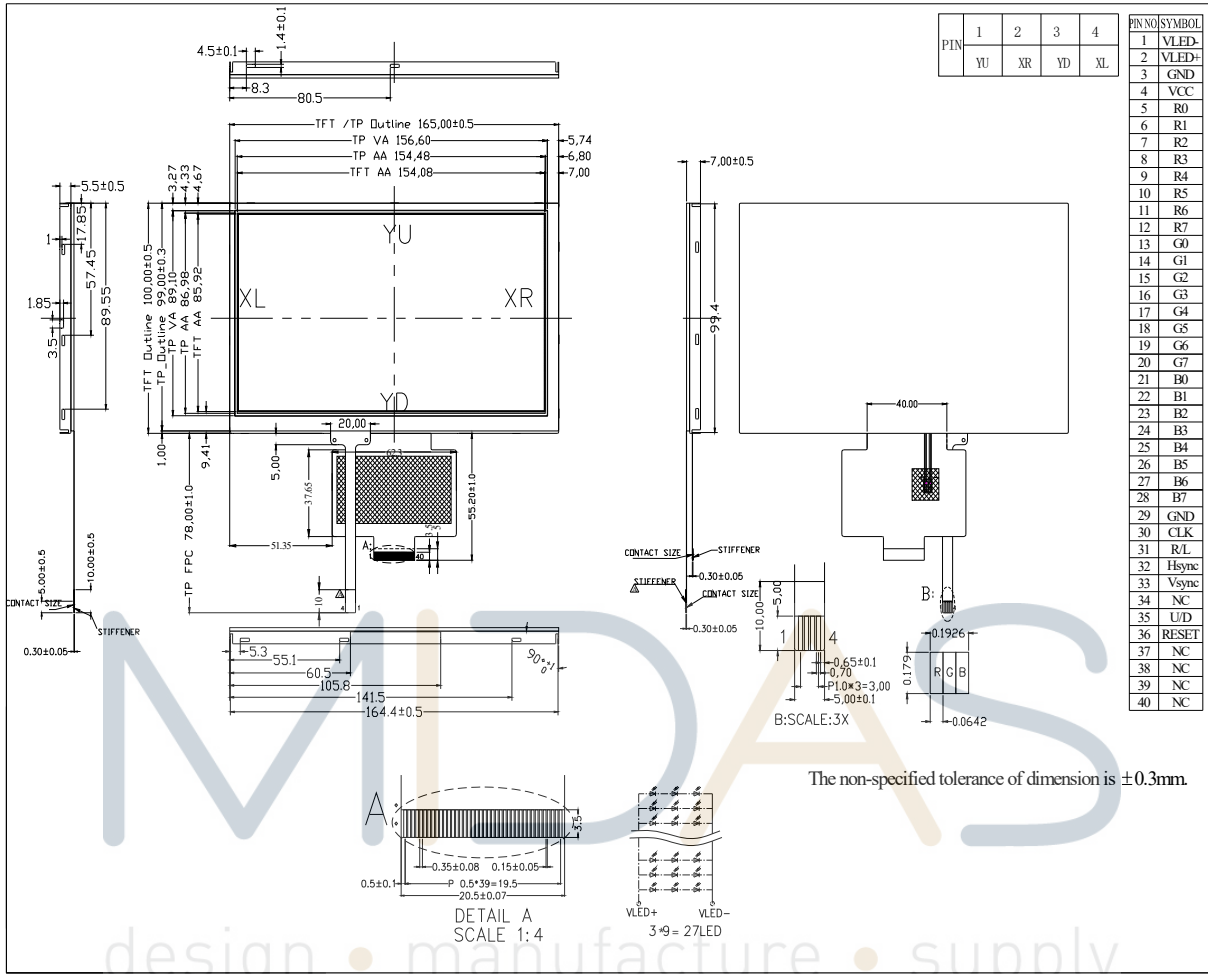

PIN	1	2	3	4
	YU	XR	YD	XL

PIN NO.	SYMBOL
1	VLED-
2	VLED+
3	GND
4	VCC
5	R0
6	R1
7	R2
8	R3
9	R4
10	R5
11	R6
12	R7
13	G0
14	G1
15	G2
16	G3
17	G4
18	G5
19	G6
20	G7
21	B0
22	B1
23	B2
24	B3
25	B4
26	B5
27	B6
28	B7
29	GND
30	CLK
31	R/L
32	Hsync
33	Vsync
34	NC
35	U/D
36	RESET
37	NC
38	NC
39	NC
40	NC

The non-specified tolerance of dimension is ±0.3mm.

DETAIL A
SCALE 1: 4

VLED+
VLED-
3*9 = 27LED

6. Block Diagram

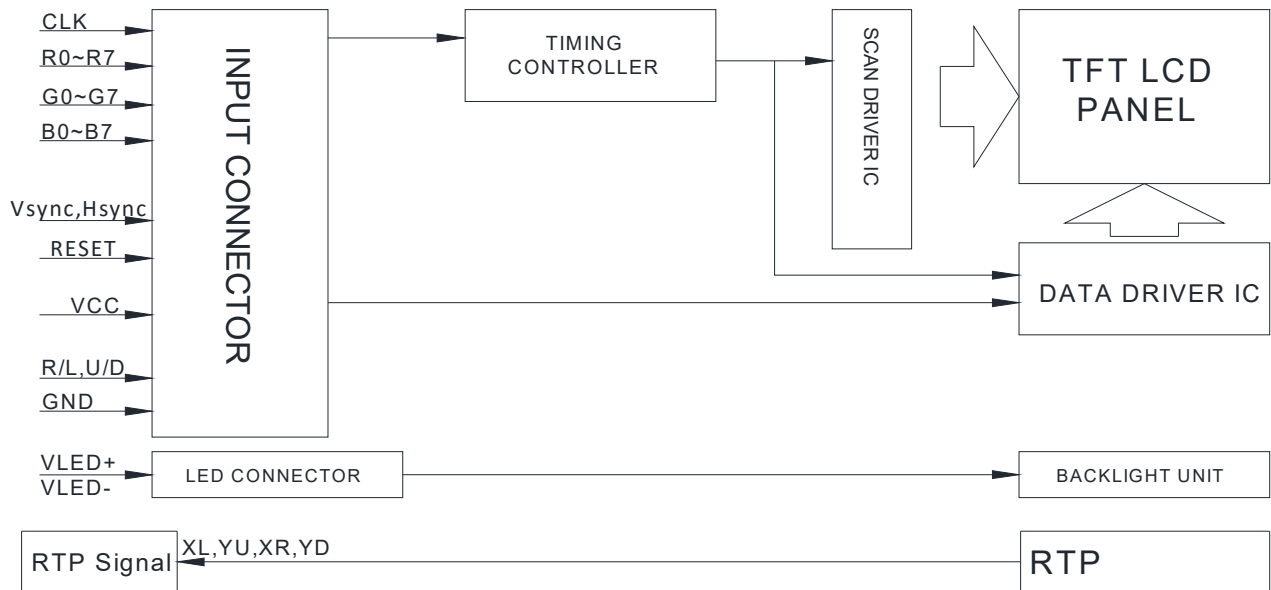

MIDAS

design • manufacture • supply



7. Absolute Maximum Ratings

Item	Symbol	Min	Typ	Max	Unit
Operating Temperature	TOP	-20	-	+70	°C
Storage Temperature	TST	-30	-	+80	°C

Note: Device is subject to be damaged permanently if stresses beyond those absolute maximum ratings listed above

- Temp. $\leq 60^{\circ}\text{C}$, 90% RH MAX. Temp. $> 60^{\circ}\text{C}$, Absolute humidity shall be less than 90% RH at 60°C

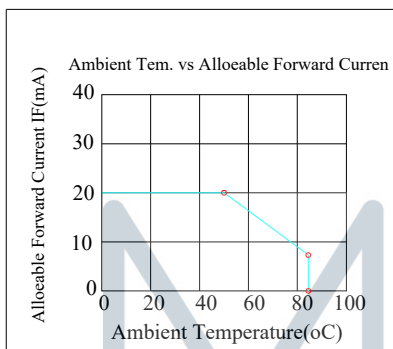

MIDAS

design • manufacture • supply



8. Electrical Characteristics

8.1. Operating conditions:

Item	Symbol	Min	Typ	Max	Unit	Remark
Supply Voltage For Logic	VCC	3.0	3.3	3.6	V	Note 1
Power Supply For Current	VCC =3.3V		110	165	mA	

Note 1 : This value is test for Vcc=3.3V , Ta=25°C only

8.2. LED driving conditions

Parameter	Symbol	Min.	Typ.	Max.	Unit	Remark
LED current	-	-	180	-	mA	-
Power Consumption	-	1620	-	1890	mW	-
LED voltage	A~K	9.0	-	10.5	V	Note 1
LED Life Time	-	-	50,000	-	Hr	Note 2,3,4

Note 1 : There are 1 Groups LED

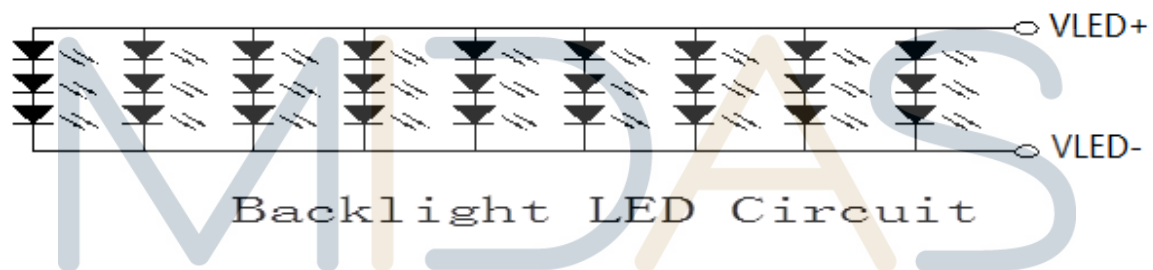

Note 2 : Ta = 25 °C

Note 3 : Brightness to be decreased to 50% of the initial value

Note 4 : The single LED lamp case

design • manufacture • supply



9.DC CHARATERISTICS

Parameter	Symbol	Rating			Unit	Condition
		Min	Typ	Max		
Low level input voltage	V_{IL}	0	-	0.3VCC	V	
High level input voltage	V_{IH}	0.7VCC	-	VCC	V	

MIDAS

design • manufacture • supply



10.AC CHARATERISTICS

10.1. AC Electrical Characteristics

Signal	Symbol	Min	Typ	Max	Unit
HS setup time	Thst	8	-	-	ns
HS hold time	Thhd	8	-	-	ns
VS setup time	Tvst	8	-	-	ns
VS hold time	Tvhd	8	-	-	ns
Data setup time	Tdsu	8	-	-	ns
Data hole time	Tdhd	8	-	-	ns
VCC Power On Slew rate	TPOR	-	-	20	ms
RESET pulse width	TRst	1	-	-	ms
DCLK cycle time	Tcoh	20	-	-	ns
DCLK pulse duty	Tcwh	40	50	60	%

10.2. Input Clock and Data Timing Diagram

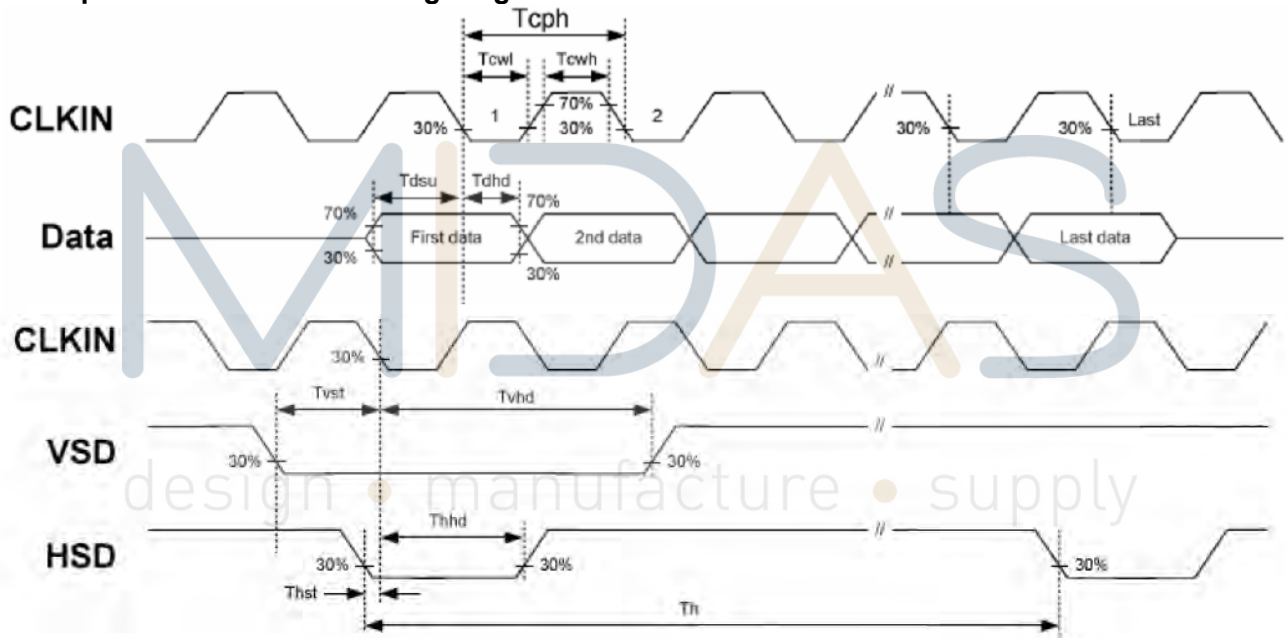

10.3. Timing

Item	Symbol	Values			Unit	Remark
		Min.	Typ.	Max.		
CLK Frequency (DCLK)	fclk	26.4	33.3	46.8	MHz	
Horizontal Display Area	thd	-	800	-	CLK	
One Horizontal Line	th	862	1056	1200	CLK	
HS pulse width	thpw	1	-	40	CLK	
HS Blanking	thb	46	46	46	CLK	
HS Front Porch	thfp	16	210	354	CLK	
Vertical Display Area	tvd	-	480	-	TH	
VS period time	tv	510	525	650	TH	
VS pulse width	tvpw	1	-	20	TH	
VS Blanking	tvb	23	23	23	TH	
VS Front Porch	tvfp	7	22	147	TH	

10.4. Data Input Format

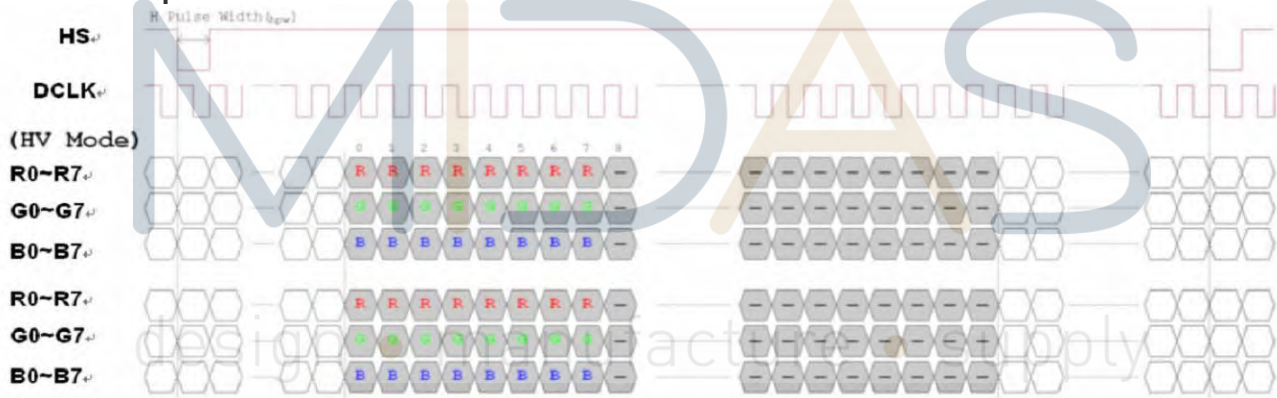

Fig. Horizontal input timing diagram

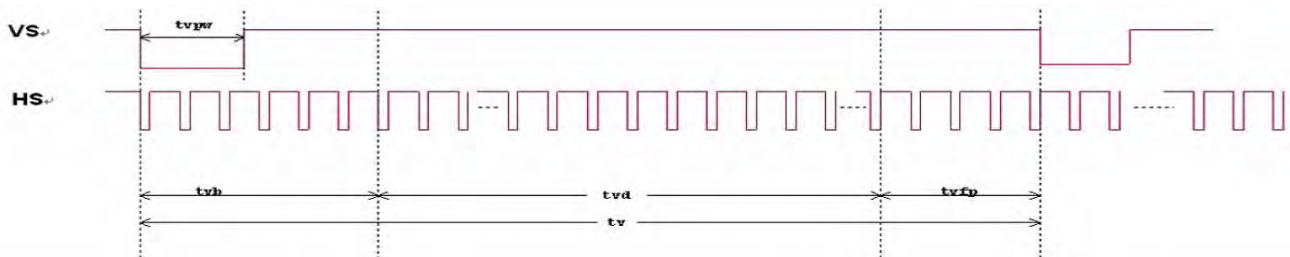

Fig. Vertical input timing diagram

11. Optical Characteristics

Item	Symbol	Condition.	Min	Typ.	Max.	Unit	Remark	
Response time	Tr	$\theta=0^\circ, \phi=0^\circ$	-	10	20	.ms	Note 3	
	Tf		-	15	30	.ms		
Contrast ratio	CR	At optimized viewing angle	400	500	-	-	Note 4	
Color Chromaticity	White	Wx	$\theta=0^\circ, \phi=0^\circ$	0.26	0.31	0.36	-	Note 2,5,6
		Wy		0.28	0.33	0.38	-	
Viewing angle (Gray Scale Inversion Direction)	Hor.	Θ_R	CR \square 10	-	75	-	Deg.	Note 1
		Θ_L		-	75	-		
	Ver.	Φ_T		-	75	-		
		Φ_B		-	75	-		
Brightness	-	-	150	250	-	cd/m ²	Center of display	

Ta=25±2□, IL=180mA

Note 1: Definition of viewing angle range

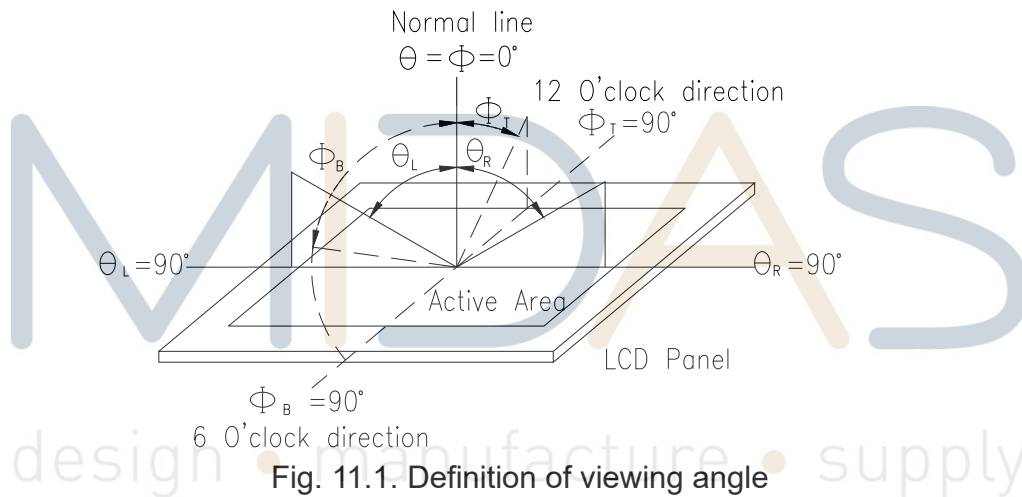

Fig. 11.1. Definition of viewing angle

Note 2: Test equipment setup:

After stabilizing and leaving the panel alone at a driven temperature for 10 minutes, the measurement should be executed. Measurement should be executed in a stable, windless, and dark room. Optical specifications are measured by Topcon BM-7orBM-5 luminance meter 1.0° field of view at a distance of 50cm and normal direction.

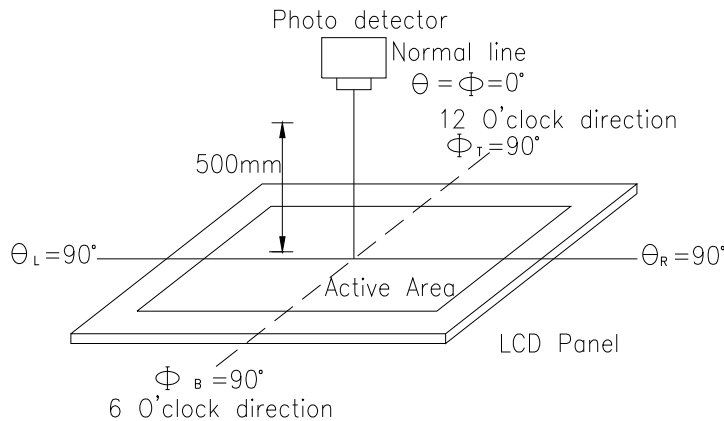
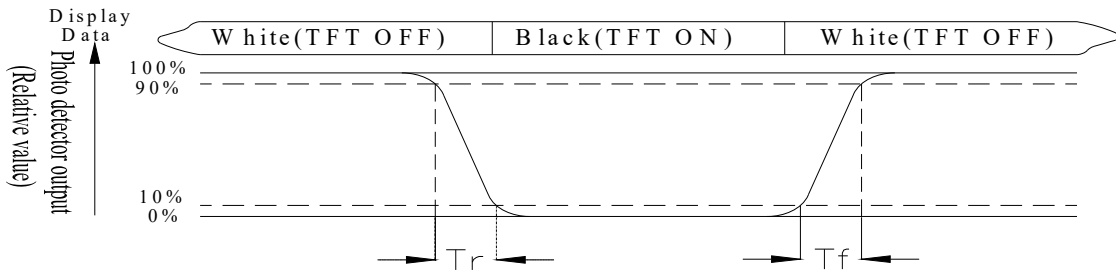

Fig. 11.2. Optical measurement system setup

Note 3: Definition of Response time:

The response time is defined as the LCD optical switching time interval between "White" state and "Black" state. Rise time, T_r , is the time between photo detector output intensity changed from 90% to 10%. And fall time, T_f , is the time between photo detector output intensity changed from 10% to 90%



Note 4: Definition of contrast ratio:

The contrast ratio is defined as the following expression.

$$\text{Contrast ratio (CR)} = \frac{\text{Luminance measured when LCD on the "White" state}}{\text{Luminance measured when LCD on the "Black" state}}$$

Note 5: White $V_i = V_{i50} \pm 1.5V$

Black $V_i = V_{i50} \pm 2.0V$

"±" means that the analog input signal swings in phase with VCOM signal.

"±" means that the analog input signal swings out of phase with VCOM signal.

The 100% transmission is defined as the transmission of LCD panel when all the input terminals of module are electrically opened.

Note 6: Definition of color chromaticity (CIE 1931)

Color coordinates measured at the center point of LCD

Note 7: Measured at the center area of the panel when all the input terminals of LCD panel are electrically opened.

12. Reliability

Content of Reliability Test (Wide temperature, -20°C~70°C)

Environmental Test			
Test Item	Content of Test	Test Condition	Note
High Temperature storage	Endurance test applying the high storage temperature for a long time.	80°C 200hrs	2
Low Temperature storage	Endurance test applying the low storage temperature for a long time.	-30°C 200hrs	1,2
High Temperature Operation	Endurance test applying the electric stress (Voltage & Current) and the thermal stress to the element for a long time.	70°C 200hrs	—
Low Temperature Operation	Endurance test applying the electric stress under low temperature for a long time.	-20°C 200hrs	1
High Temperature/ Humidity Operation	The module should be allowed to stand at 60°C, 90%RH max	60°C, 90%RH 96hrs	1,2
Thermal shock resistance	The sample should be allowed stand the following 10 cycles of operation <div style="text-align: center;"> <p style="margin: 0;">-20°C 25°C 70°C</p> <p style="margin: 0;">30min 5min 30min</p> <p style="margin: 0;">1 cycle</p> </div>	-20°C/70°C 10 cycles	—
Vibration test	Endurance test applying the vibration during transportation and using.	Total fixed amplitude : 3 15mm Vibration Frequency : 10~55Hz One cycle 60 seconds to 3 directions of X, Y, Z for Each 15 minutes	3
Static electricity test	Endurance test applying the electric stress to the terminal.	VS=±600V(contact) , ±800v(air), RS=330Ω CS=150pF 10 times	—

Note1: No dew condensation to be observed.

Note2: The function test shall be conducted after 4 hours storage at the normal Temperature and humidity after remove from the test chamber.

Note3: The packing have to including into the vibration testing.

13.Touch Panel Information

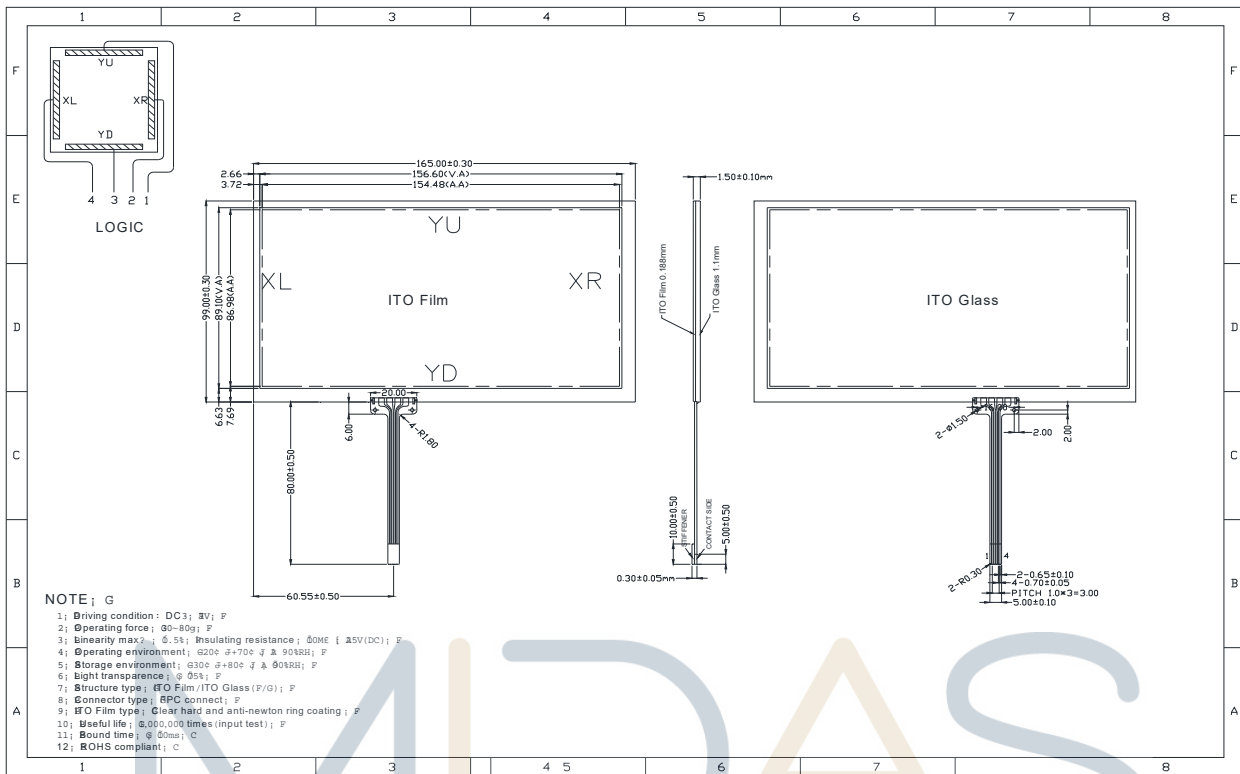

13.1. Resistance Touch Panel General Specifications

Item	Description
Driving condition	DC3~7V
Operating force	30~80g
Linearity max	≤±1.5%
Insulating resistance	> 10MΩ , 25V(DC)
Light transparence	70%
Structure type	ITO Film/ITO Glass(F/G)
Surface Hardness	3H typ
Pen Hitting Durability (with the silicon rubber)	> 1000,000 times
X Axis resistance	430~910Ω
Y Axis resistance	150~530Ω