

## FEATURES

Low drift 2.5 V on-chip reference: 2 ppm/°C typical  
Tiny package: 3 mm × 3 mm, 16-lead LFCSP

Total unadjusted error (TUE): ±0.1% of FSR maximum  
Offset error: ±1.5 mV maximum  
Gain error: ±0.1% of FSR maximum  
High drive capability: 20 mA, 0.5 V from supply rails  
User-selectable gain of 1 or 2 (GAIN pin)  
Reset to zero scale or midscale (RSTSEL pin)  
1.8 V logic compatibility  
400 kHz I<sup>2</sup>C-compatible serial interface  
4 I<sup>2</sup>C addresses available  
Low glitch: 0.5 nV-sec  
Robust 3.5 kV HBM and 1.5 kV FICDM ESD rating  
Low power: 3.3 mW at 3 V  
2.7 V to 5.5 V power supply  
−40°C to +105°C temperature range

## APPLICATIONS

Digital gain and offset adjustment  
Programmable attenuators  
Industrial automation  
Data acquisition systems

## GENERAL DESCRIPTION

The AD5316R, a member of the *nano*DAC® family, is a low power, quad, 10-bit buffered voltage output DAC. The device includes a 2.5 V, 2 ppm/°C internal reference (enabled by default) and a gain select pin giving a full-scale output of 2.5 V (gain = 1) or 5 V (gain = 2). The device operates from a single 2.7 V to 5.5 V supply, is guaranteed monotonic by design, and exhibits less than 0.1% FSR gain error and 1.5 mV offset error performance. The device is available in a 3 mm × 3 mm LFCSP package and in a TSSOP package.

The AD5316R also incorporates a power-on reset circuit and a RSTSEL pin; the RSTSEL pin ensures that the DAC outputs power up to zero scale or midscale and remain at that level until a valid write takes place. The part contains a per-channel power-down feature that reduces the current consumption of the device in power-down mode to 4 μA at 3 V.

The AD5316R uses a versatile 2-wire serial interface that operates at clock rates up to 400 kHz and includes a V<sub>LOGIC</sub> pin intended for 1.8 V/3 V/5 V logic.

## FUNCTIONAL BLOCK DIAGRAM

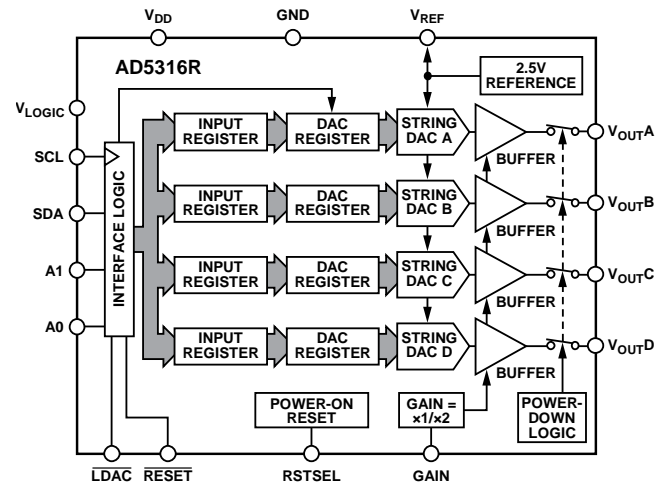

Figure 1.

Table 1. Related Devices

Interface	Reference	12-Bit	10-Bit
SPI	Internal	AD5684R	AD5317R
	External	AD5684	AD5317
I <sup>2</sup> C	Internal	AD5694R	
	External	AD5694	AD5316 <sup>1</sup>

<sup>1</sup> The AD5316R and the AD5316 are not pin-to-pin or software compatible.

## PRODUCT HIGHLIGHTS

- Precision DC Performance.
  - Total unadjusted error: ±0.1% of FSR maximum
  - Offset error: ±1.5 mV maximum
  - Gain error: ±0.1% of FSR maximum
- Low Drift 2.5 V On-Chip Reference.
  - 2 ppm/°C typical temperature coefficient
  - 5 ppm/°C maximum temperature coefficient
- Two Package Options.
  - 3 mm × 3 mm, 16-lead LFCSP
  - 16-lead TSSOP

Rev. B

[Document Feedback](#)

Information furnished by Analog Devices is believed to be accurate and reliable. However, no responsibility is assumed by Analog Devices for its use, nor for any infringements of patents or other rights of third parties that may result from its use. Specifications subject to change without notice. No license is granted by implication or otherwise under any patent or patent rights of Analog Devices. Trademarks and registered trademarks are the property of their respective owners.

# AD5316R\* Product Page Quick Links

Last Content Update: 08/30/2016

---

## [Comparable Parts](#)

View a parametric search of comparable parts

## [Documentation](#)

### **Data Sheet**

- AD5316R: Quad, 10-Bit nanoDAC with 2 ppm/°C Reference, I2C Interface Data Sheet

## [Reference Materials](#)

### **Press**

- Analog Devices Expands Its Industry Leading D/A Converter Portfolio

## [Design Resources](#)

- AD5316R Material Declaration
- PCN-PDN Information
- Quality And Reliability
- Symbols and Footprints

## [Discussions](#)

View all AD5316R EngineerZone Discussions

## [Sample and Buy](#)

Visit the product page to see pricing options

## [Technical Support](#)

Submit a technical question or find your regional support number

---

## TABLE OF CONTENTS

Features .....	1	I <sup>2</sup> C Slave Address.....	18
Applications.....	1	Serial Operation .....	18
Functional Block Diagram .....	1	Write Operation.....	18
General Description .....	1	Read Operation.....	19
Product Highlights .....	1	Multiple DAC Readback Sequence .....	19
Revision History .....	2	Power-Down Operation .....	20
Specifications.....	3	Load DAC (Hardware $\overline{\text{LDAC}}$ Pin).....	20
AC Characteristics.....	4	$\overline{\text{LDAC}}$ Mask Register .....	21
Timing Characteristics .....	5	Hardware Reset Pin ( $\overline{\text{RESET}}$ ) .....	21
Absolute Maximum Ratings.....	6	Reset Select Pin (RSTSEL) .....	21
Thermal Resistance .....	6	Internal Reference Setup .....	22
ESD Caution.....	6	Solder Heat Reflow.....	22
Pin Configurations and Function Descriptions .....	7	Thermal Hysteresis .....	22
Typical Performance Characteristics .....	8	Applications Information .....	23
Terminology .....	14	Microprocessor Interfacing.....	23
Theory of Operation .....	16	AD5316R to ADSP-BF531 Interface.....	23
Digital-to-Analog Converter .....	16	Layout Guidelines.....	23
Transfer Function .....	16	Galvanically Isolated Interface .....	23
DAC Architecture.....	16	Outline Dimensions .....	24
Serial Interface .....	17	Ordering Guide .....	24
Write and Update Commands.....	17		

## REVISION HISTORY

### 2/14—Rev. A to Rev. B

Change to Table 2 .....	3
Change to Table 7 .....	9
Deleted Figure 7, Renumbered Sequentially.....	8
Deleted Long-Term Temperature Drift Section and Figure 48 .....	22

### 7/12—Rev. 0 to Rev. A

Change to Features Section.....	1
Change to Relative Accuracy Parameter in Table 2 .....	3
Change to Differential Nonlinearity Parameter in Table 2.....	3
Changes to Ordering Guide .....	24

### 7/12—Revision 0: Initial Version

## SPECIFICATIONS

$V_{DD} = 2.7\text{ V to }5.5\text{ V}$ ;  $V_{REF} = 2.5\text{ V}$ ;  $1.8\text{ V} \leq V_{LOGIC} \leq 5.5\text{ V}$ ;  $R_L = 2\text{ k}\Omega$ ;  $C_L = 200\text{ pF}$ ; all specifications  $T_{MIN}$  to  $T_{MAX}$ , unless otherwise noted.

Table 2.

Parameter	Min	Typ	Max	Unit	Test Conditions/Comments <sup>1, 2</sup>
<b>STATIC PERFORMANCE<sup>3</sup></b>					
Resolution	10			Bits	
Relative Accuracy		$\pm 0.12$	$\pm 0.5$	LSB	
Differential Nonlinearity			$\pm 0.5$	LSB	Guaranteed monotonic by design
Zero-Code Error		0.4	1.5	mV	All 0s loaded to DAC register
Offset Error		+0.1	$\pm 1.5$	mV	
Full-Scale Error		+0.01	$\pm 0.1$	% of FSR	All 1s loaded to DAC register
Gain Error		$\pm 0.02$	$\pm 0.1$	% of FSR	
Total Unadjusted Error		$\pm 0.01$	$\pm 0.1$	% of FSR	External reference, gain = 2, TSSOP
			$\pm 0.2$	% of FSR	Internal reference, gain = 1, TSSOP
Offset Error Drift <sup>4</sup>		$\pm 1$		$\mu\text{V}/^\circ\text{C}$	
Gain Temperature Coefficient <sup>4</sup>		$\pm 1$		ppm	Of FSR/ $^\circ\text{C}$
DC Power Supply Rejection Ratio <sup>4</sup>		0.15		mV/V	DAC code = midscale; $V_{DD} = 5\text{ V} \pm 10\%$
DC Crosstalk <sup>4</sup>		$\pm 2$		$\mu\text{V}$	Due to single channel, full-scale output change
		$\pm 3$		$\mu\text{V}/\text{mA}$	Due to load current change
		$\pm 2$		$\mu\text{V}$	Due to power-down (per channel)
<b>OUTPUT CHARACTERISTICS<sup>4</sup></b>					
Output Voltage Range	0		$V_{REF}$	V	Gain = 1
	0		$2 \times V_{REF}$	V	Gain = 2 (see Figure 25)
Capacitive Load Stability		2		nF	$R_L = \infty$
		10		nF	$R_L = 1\text{ k}\Omega$
Resistive Load <sup>5</sup>	1			k $\Omega$	
Load Regulation					DAC code = midscale
		80		$\mu\text{V}/\text{mA}$	$5\text{ V} \pm 10\%$ ; $-30\text{ mA} \leq I_{OUT} \leq +30\text{ mA}$
		80		$\mu\text{V}/\text{mA}$	$3\text{ V} \pm 10\%$ ; $-20\text{ mA} \leq I_{OUT} \leq +20\text{ mA}$
Short-Circuit Current <sup>6</sup>		40		mA	
Load Impedance at Rails <sup>7</sup>		25		$\Omega$	See Figure 25
Power-Up Time		2.5		$\mu\text{s}$	Coming out of power-down mode; $V_{DD} = 5\text{ V}$
<b>REFERENCE OUTPUT</b>					
Output Voltage <sup>8</sup>	2.4975		2.5025	V	At $T_A$
Reference TC <sup>9</sup>		2	5	ppm/ $^\circ\text{C}$	See the Terminology section
Output Impedance <sup>4</sup>		0.04		$\Omega$	
Output Voltage Noise <sup>4</sup>		12		$\mu\text{V p-p}$	0.1 Hz to 10 Hz
Output Voltage Noise Density <sup>4</sup>		240		nV/ $\sqrt{\text{Hz}}$	At $T_A$ , $f = 10\text{ kHz}$ , $C_L = 10\text{ nF}$
Load Regulation, Sourcing <sup>4</sup>		20		$\mu\text{V}/\text{mA}$	At $T_A$
Load Regulation, Sinking <sup>4</sup>		40		$\mu\text{V}/\text{mA}$	At $T_A$
Output Current Load Capability <sup>4</sup>		$\pm 5$		mA	$V_{DD} \geq 3\text{ V}$
Line Regulation <sup>4</sup>		100		$\mu\text{V}/\text{V}$	At $T_A$
Thermal Hysteresis <sup>4</sup>		125		ppm	First cycle
		25		ppm	Additional cycles
<b>LOGIC INPUTS<sup>4</sup></b>					
Input Current			$\pm 2$	$\mu\text{A}$	Per pin
Input Low Voltage, $V_{INL}$			$0.3 \times V_{LOGIC}$	V	
Input High Voltage, $V_{INH}$	$0.7 \times V_{LOGIC}$			V	
Pin Capacitance		2		pF	

Parameter	Min	Typ	Max	Unit	Test Conditions/Comments <sup>1, 2</sup>
LOGIC OUTPUTS (SDA) <sup>4</sup>					
Output Low Voltage, $V_{OL}$			0.4	V	$I_{SINK} = 3 \text{ mA}$
Floating State Output Capacitance		4		pF	
POWER REQUIREMENTS					
$V_{LOGIC}$	1.8		5.5	V	Gain = 1 Gain = 2 $V_{IH} = V_{DD}$ , $V_{IL} = \text{GND}$ , $V_{DD} = 2.7 \text{ V to } 5.5 \text{ V}$
$I_{LOGIC}$			3	$\mu\text{A}$	
$V_{DD}$	2.7		5.5	V	
$V_{DD}$	$V_{REF} + 1.5$		5.5	V	
$I_{DD}$					Internal reference off Internal reference on, at full scale
Normal Mode <sup>10</sup>		0.59	0.7	mA	
		1.1	1.3	mA	
All Power-Down Modes <sup>11</sup>		1	4	$\mu\text{A}$	-40°C to +85°C
			6	$\mu\text{A}$	

<sup>1</sup> Temperature range is -40°C to +105°C.

<sup>2</sup> The AD5316R and the AD5316 are not pin-to-pin or software compatible.

<sup>3</sup> DC specifications are tested with the outputs unloaded, unless otherwise noted. Upper dead band (10 mV) exists only when  $V_{REF} = V_{DD}$  with gain = 1 or when  $V_{REF}/2 = V_{DD}$  with gain = 2. Linearity calculated using a reduced code range of 4 to 1020.

<sup>4</sup> Guaranteed by design and characterization; not production tested.

<sup>5</sup> Channel A and Channel B can have a combined output current of up to 30 mA. Similarly, Channel C and Channel D can have a combined output current of up to 30 mA up to a junction temperature of 110°C.

<sup>6</sup>  $V_{DD} = 5 \text{ V}$ . The device includes current limiting that is intended to protect the device during temporary overload conditions. Junction temperature can be exceeded during current limit. Operation above the specified maximum junction temperature may impair device reliability.

<sup>7</sup> When drawing a load current at either rail, the output voltage headroom with respect to that rail is limited by the 25  $\Omega$  typical channel resistance of the output devices. For example, when sinking 1 mA, the minimum output voltage =  $25 \Omega \times 1 \text{ mA} = 25 \text{ mV}$  (see Figure 25).

<sup>8</sup> Initial accuracy presolder reflow is  $\pm 750 \mu\text{V}$ ; output voltage includes the effects of preconditioning drift. See the Solder Heat Reflow section.

<sup>9</sup> Reference is trimmed and tested at two temperatures and is characterized from -40°C to +105°C. Reference temperature coefficient is calculated as per the box method. See the Terminology section for more information.

<sup>10</sup> Interface inactive. All DACs active. DAC outputs unloaded.

<sup>11</sup> All DACs powered down.

## AC CHARACTERISTICS

$V_{DD} = 2.7 \text{ V to } 5.5 \text{ V}$ ;  $V_{REF} = 2.5 \text{ V}$ ;  $1.8 \text{ V} \leq V_{LOGIC} \leq 5.5 \text{ V}$ ;  $R_L = 2 \text{ k}\Omega$ ;  $C_L = 200 \text{ pF}$ ; all specifications  $T_{MIN}$  to  $T_{MAX}$ , unless otherwise noted.

Table 3.

Parameter <sup>1, 2</sup>	Min	Typ	Max	Unit	Test Conditions/Comments <sup>3</sup>
Output Voltage Settling Time		5	7	$\mu\text{s}$	$\frac{1}{4}$ to $\frac{3}{4}$ scale settling to $\pm 1 \text{ LSB}$
Slew Rate		0.8		V/ $\mu\text{s}$	
Digital-to-Analog Glitch Impulse		0.5		nV-sec	1 LSB change around major carry transition
Digital Feedthrough		0.13		nV-sec	
Digital Crosstalk		0.1		nV-sec	
Analog Crosstalk		0.2		nV-sec	
DAC-to-DAC Crosstalk		0.3		nV-sec	At $T_A$ , $BW = 20 \text{ kHz}$ , $V_{DD} = 5 \text{ V}$ , $f_{OUT} = 1 \text{ kHz}$
Total Harmonic Distortion <sup>4</sup>		-80		dB	
Output Noise Spectral Density		300		nV/ $\sqrt{\text{Hz}}$	
Output Noise		6		$\mu\text{V p-p}$	0.1 Hz to 10 Hz

<sup>1</sup> Guaranteed by design and characterization; not production tested.

<sup>2</sup> See the Terminology section.

<sup>3</sup> Temperature range is -40°C to +105°C; typical at 25°C.

<sup>4</sup> Digitally generated sine wave at 1 kHz.

**TIMING CHARACTERISTICS**

$V_{DD} = 2.7\text{ V to } 5.5\text{ V}$ ;  $1.8\text{ V} \leq V_{LOGIC} \leq 5.5\text{ V}$ ; all specifications  $T_{MIN}$  to  $T_{MAX}$ , unless otherwise noted.

Table 4.

Parameter <sup>1,2</sup>	Min	Max	Unit	Description
$t_1$	2.5		$\mu\text{s}$	SCL cycle time
$t_2$	0.6		$\mu\text{s}$	$t_{HIGH}$ , SCL high time
$t_3$	1.3		$\mu\text{s}$	$t_{LOW}$ , SCL low time
$t_4$	0.6		$\mu\text{s}$	$t_{HD,STA}$ , start/repeated start hold time
$t_5$	100		ns	$t_{SU,DAT}$ , data setup time
$t_6^3$	0	0.9	$\mu\text{s}$	$t_{HD,DAT}$ , data hold time
$t_7$	0.6		$\mu\text{s}$	$t_{SU,STA}$ , repeated start setup time
$t_8$	0.6		$\mu\text{s}$	$t_{SU,STO}$ , stop condition setup time
$t_9$	1.3		$\mu\text{s}$	$t_{BUF}$ , bus free time between a stop condition and a start condition
$t_{10}^4$	0	300	ns	$t_R$ , rise time of SCL and SDA when receiving
$t_{11}^{4,5}$	$20 + 0.1C_B$	300	ns	$t_F$ , fall time of SCL and SDA when transmitting/receiving
$t_{12}$	20		ns	$\overline{LDAC}$ pulse width
$t_{13}$	400		ns	SCL rising edge to $\overline{LDAC}$ rising edge
$t_{SP}^6$	0	50	ns	Pulse width of suppressed spike
$C_B^5$		400	pF	Capacitive load for each bus line

<sup>1</sup> See Figure 2.

<sup>2</sup> Guaranteed by design and characterization; not production tested.

<sup>3</sup> A master device must provide a hold time of at least 300 ns for the SDA signal (referred to the  $V_{IH}$  min of the SCL signal) to bridge the undefined region of the SCL falling edge.

<sup>4</sup>  $t_R$  and  $t_F$  are measured from  $0.3 \times V_{DD}$  to  $0.7 \times V_{DD}$ .

<sup>5</sup>  $C_B$  is the total capacitance of one bus line in pF.

<sup>6</sup> Input filtering on the SCL and SDA inputs suppresses noise spikes that are less than 50 ns.

**Timing Diagram**

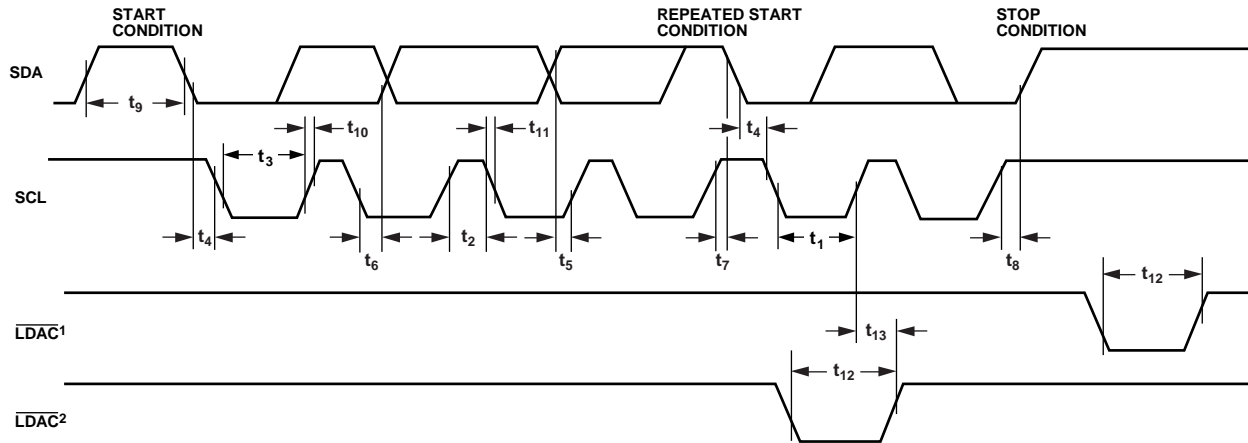

NOTES

<sup>1</sup>ASYNCHRONOUS  $\overline{LDAC}$  UPDATE MODE.

<sup>2</sup>SYNCHRONOUS  $\overline{LDAC}$  UPDATE MODE.

Figure 2. 2-Wire Serial Interface Timing Diagram

10819-002

## ABSOLUTE MAXIMUM RATINGS

$T_A = 25^\circ\text{C}$ , unless otherwise noted.

Table 5.

Parameter	Rating
$V_{DD}$ to GND	-0.3 V to +7 V
$V_{LOGIC}$ to GND	-0.3 V to +7 V
$V_{OUT}$ to GND	-0.3 V to $V_{DD} + 0.3$ V
$V_{REF}$ to GND	-0.3 V to $V_{DD} + 0.3$ V
Digital Input Voltage to GND <sup>1</sup>	-0.3 V to $V_{LOGIC} + 0.3$ V
SDA and SCL to GND	-0.3 V to +7 V
Operating Temperature Range	-40°C to +105°C
Storage Temperature Range	-65°C to +150°C
Junction Temperature	125°C
Reflow Soldering Peak Temperature, Pb Free (J-STD-020)	260°C
ESD	
Human Body Model (HBM)	3.5 kV
Field-Induced Charged Device Model (FICDM)	1.5 kV

<sup>1</sup> Excluding SDA and SCL.

Stresses above those listed under Absolute Maximum Ratings may cause permanent damage to the device. This is a stress rating only; functional operation of the device at these or any other conditions above those indicated in the operational section of this specification is not implied. Exposure to absolute maximum rating conditions for extended periods may affect device reliability.

## THERMAL RESISTANCE

$\theta_{JA}$  is specified for the worst-case conditions, that is, a device soldered in a circuit board for surface-mount packages. This value was measured using a JEDEC standard 4-layer board with zero airflow. For the LFCSP package, the exposed pad must be tied to GND.

Table 6. Thermal Resistance

Package Type	$\theta_{JA}$	Unit
16-Lead LFCSP	70	°C/W
16-Lead TSSOP	112.6	°C/W

## ESD CAUTION



**ESD (electrostatic discharge) sensitive device.** Charged devices and circuit boards can discharge without detection. Although this product features patented or proprietary protection circuitry, damage may occur on devices subjected to high energy ESD. Therefore, proper ESD precautions should be taken to avoid performance degradation or loss of functionality.

# PIN CONFIGURATIONS AND FUNCTION DESCRIPTIONS

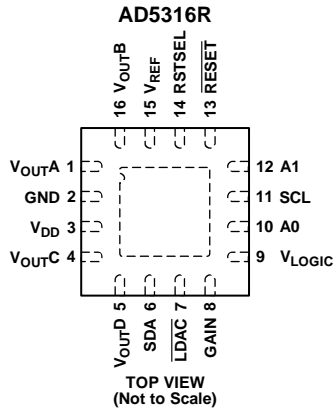

NOTES  
1. THE EXPOSED PAD MUST BE TIED TO GND.

Figure 3. 16-Lead LFCSP Pin Configuration

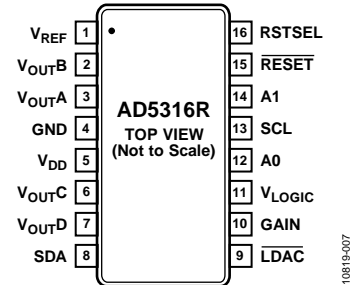

Figure 4. 16-Lead TSSOP Pin Configuration

Table 7. Pin Function Descriptions

Pin No.		Mnemonic	Description
LFCSP	TSSOP		
1	3	V <sub>OUTA</sub>	Analog Output Voltage from DAC A. The output amplifier has rail-to-rail operation.
2	4	GND	Ground Reference Point for All Circuitry on the Part.
3	5	V <sub>DD</sub>	Power Supply Input. The part can be operated from 2.7V to 5.5V. The supply should be decoupled with a 10 μF capacitor in parallel with a 0.1 μF capacitor to GND.
4	6	V <sub>OUTC</sub>	Analog Output Voltage from DAC C. The output amplifier has rail-to-rail operation.
5	7	V <sub>OUTD</sub>	Analog Output Voltage from DAC D. The output amplifier has rail-to-rail operation.
6	8	SDA	Serial Data Input. This pin is used in conjunction with the SCL line to clock data into or out of the 24-bit input shift register. SDA is a bidirectional, open-drain data line that should be pulled to the supply with an external pull-up resistor.
7	9	LDAC	LDAC can be operated in two modes, asynchronous update mode and synchronous update mode. Pulsing this pin low allows any or all DAC registers to be updated if the input registers have new data; all DAC outputs are simultaneously updated. This pin can also be tied permanently low.
8	10	GAIN	Gain Select Pin. When this pin is tied to GND, all four DAC outputs have a span of 0V to V <sub>REF</sub> . When this pin is tied to V <sub>LOGIC</sub> , all four DAC outputs have a span of 0V to 2 × V <sub>REF</sub> .
9	11	V <sub>LOGIC</sub>	Digital Power Supply. Voltage ranges from 1.8V to 5.5V.
10	12	A0	Address Input. Sets the first LSB of the 7-bit slave address.
11	13	SCL	Serial Clock Line. This pin is used in conjunction with the SDA line to clock data into or out of the 24-bit input shift register.
12	14	A1	Address Input. Sets the second LSB of the 7-bit slave address.
13	15	RESET	Asynchronous Reset Input. The RESET input is falling edge sensitive. When RESET is activated (low), the input register and the DAC register are updated with zero scale or midscale, depending on the state of the RSTSEL pin. When RESET is low, all LDAC pulses are ignored. If the pin is not used, tie it permanently to V <sub>LOGIC</sub> .
14	16	RSTSEL	Power-On Reset Pin. When this pin is tied to GND, all four DACs are powered up to zero scale. When this pin is tied to V <sub>LOGIC</sub> , all four DACs are powered up to midscale.
15	1	V <sub>REF</sub>	Reference Voltage. The AD5316R has an internal reference. When the internal reference is used, V <sub>REF</sub> is the reference output pin. When an external reference is used, V <sub>REF</sub> is the reference input pin. By default, the internal reference is used, and this pin is a reference output.
16	2	V <sub>OUTB</sub>	Analog Output Voltage from DAC B. The output amplifier has rail-to-rail operation.
17	N/A	EPAD	Exposed Pad. The exposed pad must be tied to GND.



TYPICAL PERFORMANCE CHARACTERISTICS

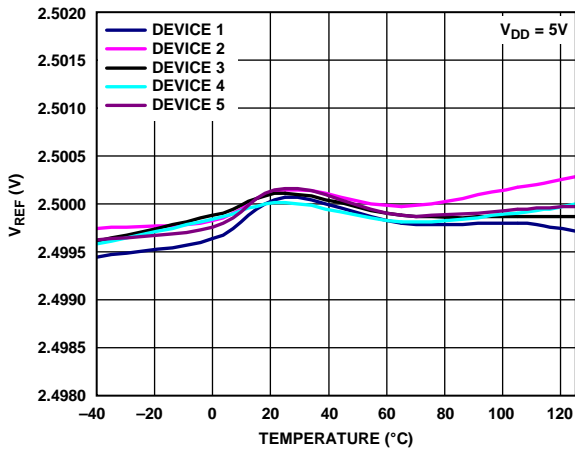

Figure 5. Internal Reference Voltage vs. Temperature

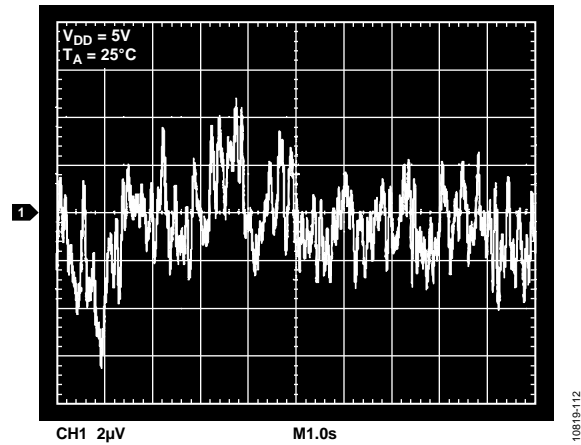

Figure 8. Internal Reference Noise, 0.1 Hz to 10 Hz

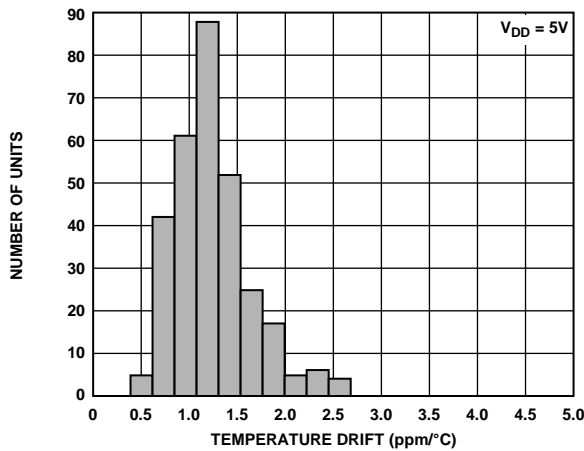

Figure 6. Reference Output Temperature Drift Histogram

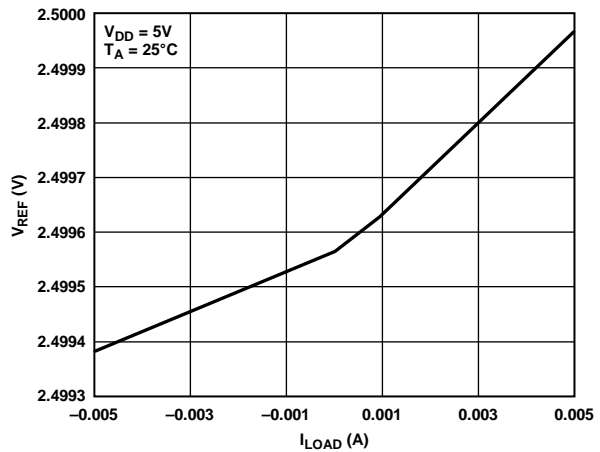

Figure 9. Internal Reference Voltage vs. Load Current

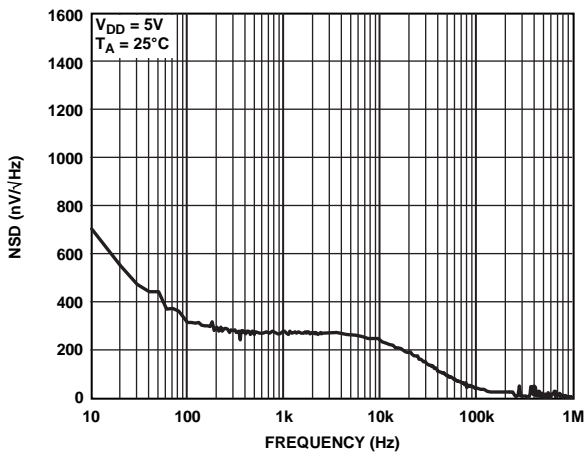

Figure 7. Internal Reference Noise Spectral Density vs. Frequency

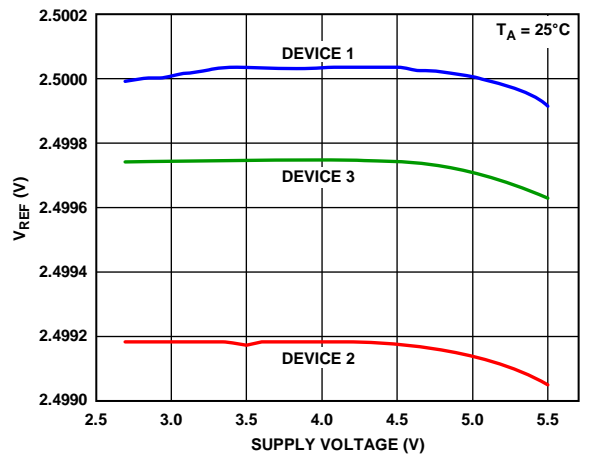

Figure 10. Internal Reference Voltage vs. Supply Voltage

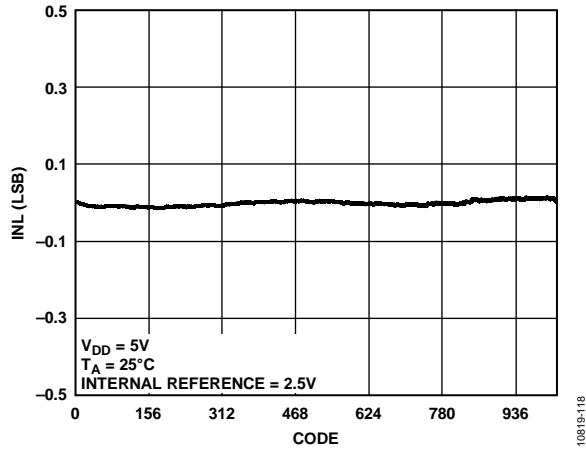

Figure 11. INL

10819-118

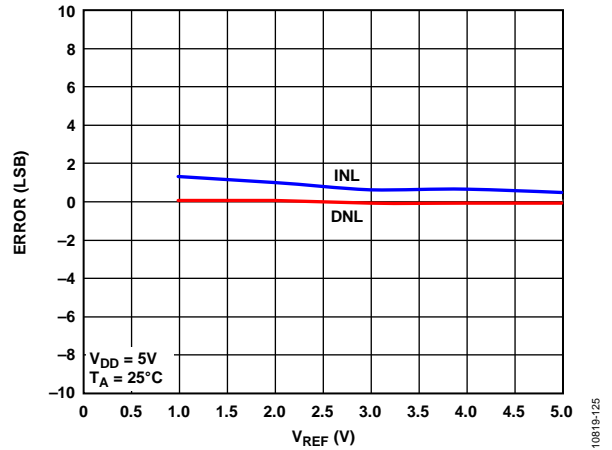

Figure 14. INL Error and DNL Error vs.  $V_{REF}$

10819-125

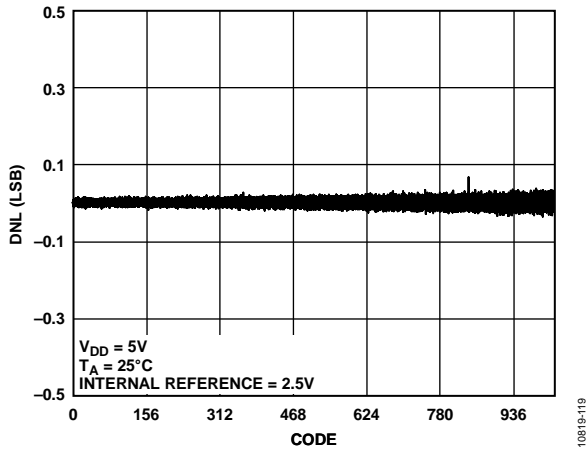

Figure 12. DNL

10819-119

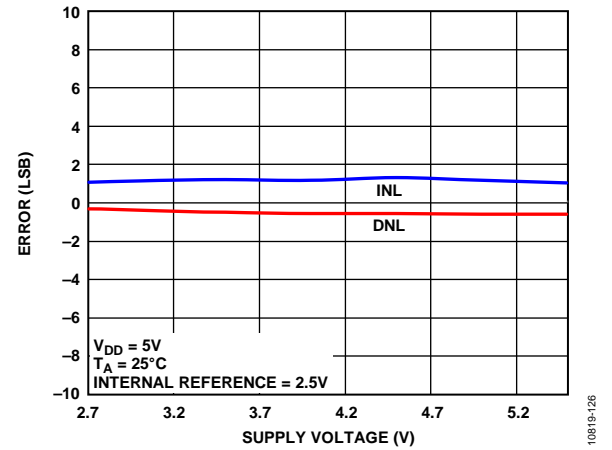

Figure 15. INL Error and DNL Error vs. Supply Voltage

10819-126

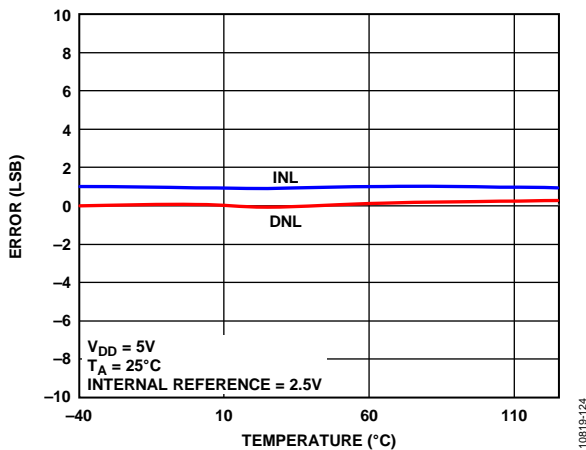

Figure 13. INL Error and DNL Error vs. Temperature

10819-124

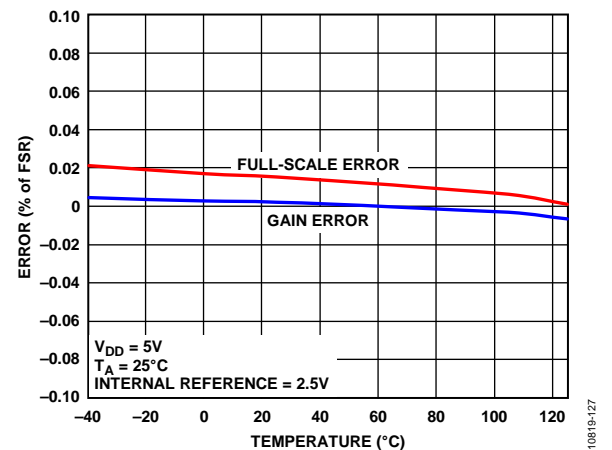

Figure 16. Gain Error and Full-Scale Error vs. Temperature

10819-127

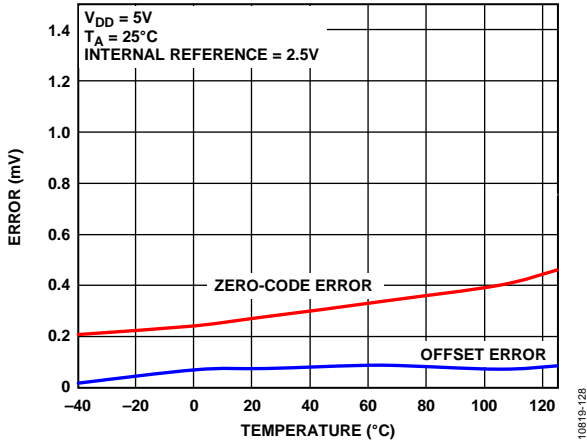

Figure 17. Zero-Code Error and Offset Error vs. Temperature

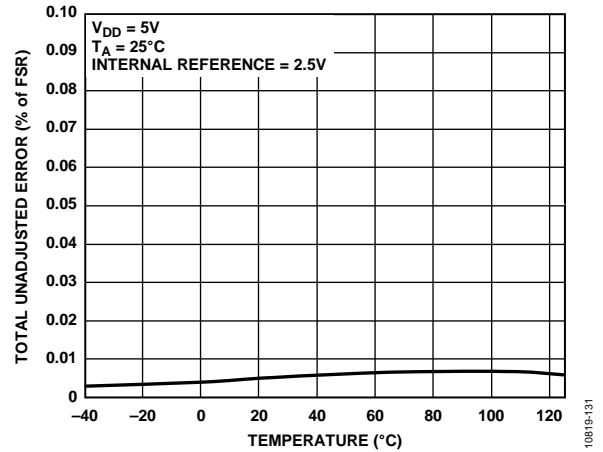

Figure 20. TUE vs. Temperature

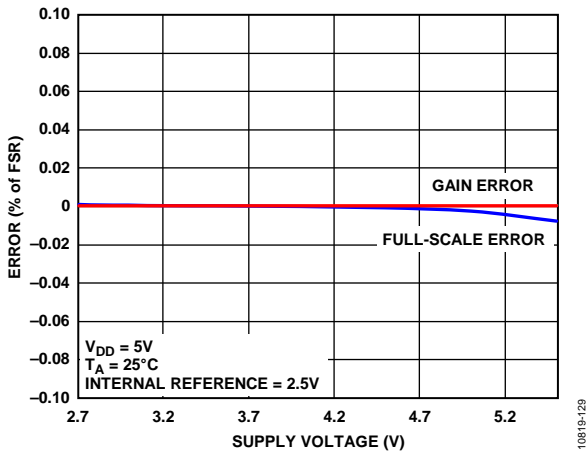

Figure 18. Gain Error and Full-Scale Error vs. Supply Voltage

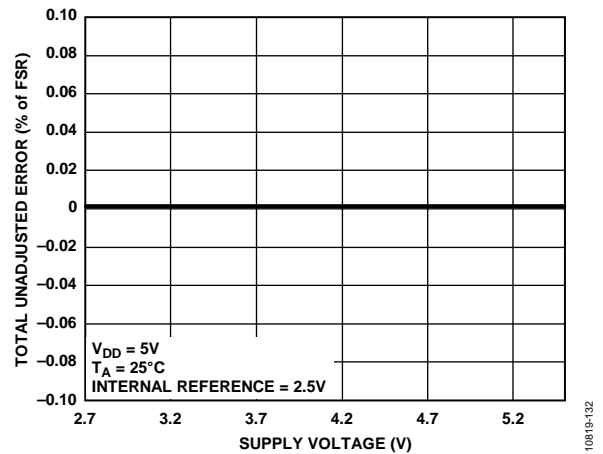

Figure 21. TUE vs. Supply Voltage, Gain = 1

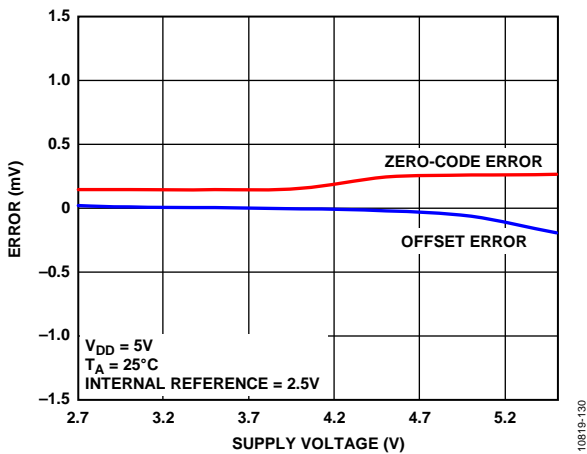

Figure 19. Zero-Code Error and Offset Error vs. Supply Voltage

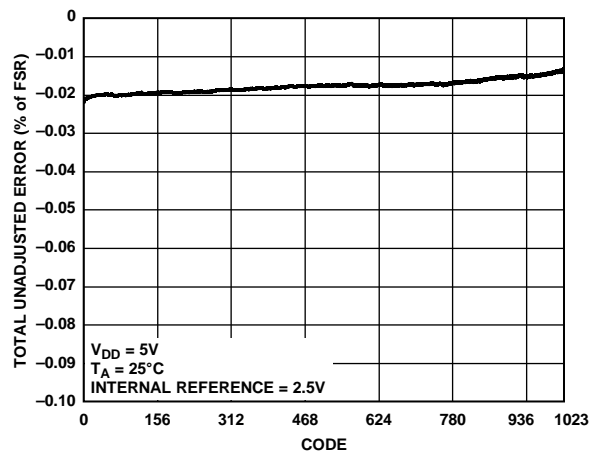

Figure 22. TUE vs. Code

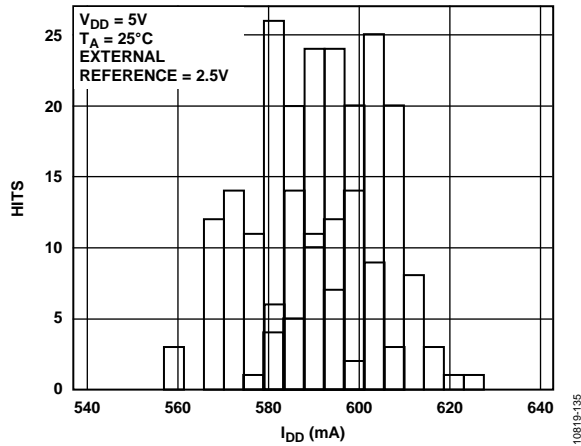

Figure 23.  $I_{DD}$  Histogram with External Reference, 5 V

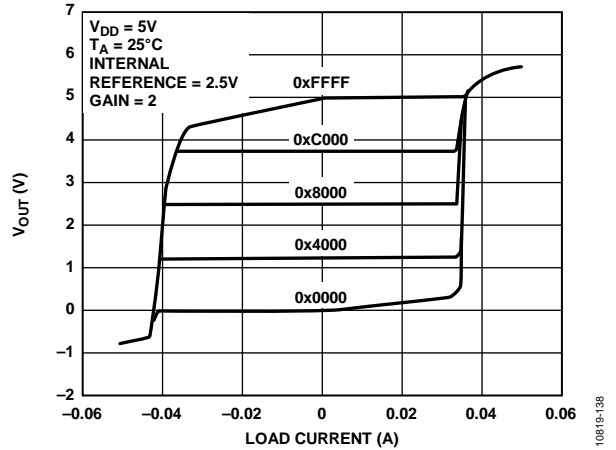

Figure 26. Source and Sink Capability at 5 V

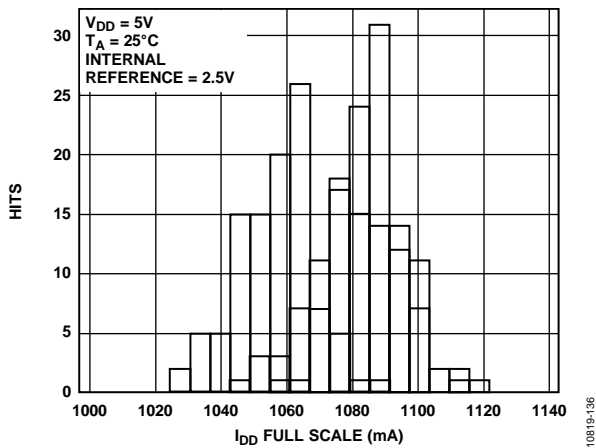

Figure 24.  $I_{DD}$  Histogram with Internal Reference,  $V_{REF} = 2.5$  V, Gain = 2

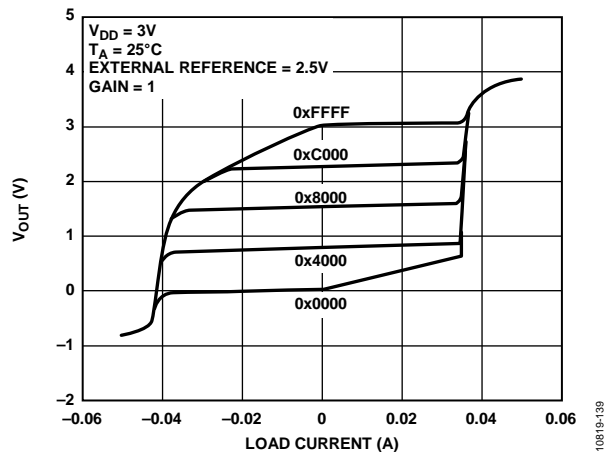

Figure 27. Source and Sink Capability at 3 V

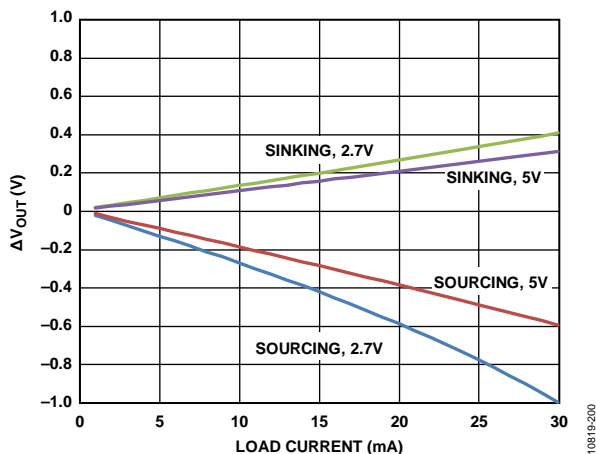

Figure 25. Headroom/Footroom vs. Load Current

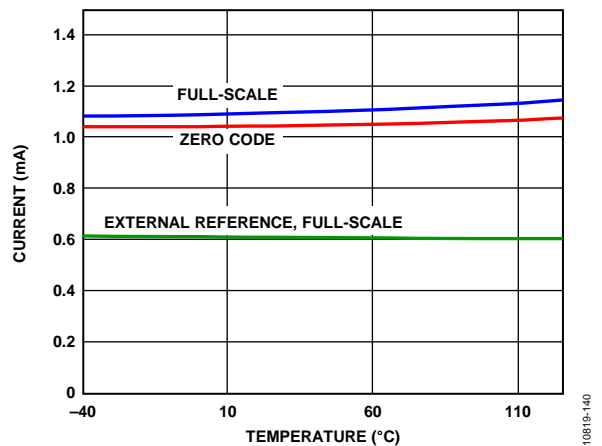

Figure 28. Supply Current vs. Temperature

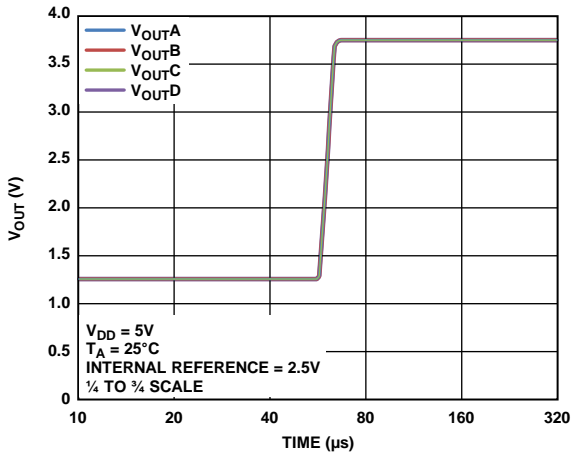

Figure 29. Settling Time

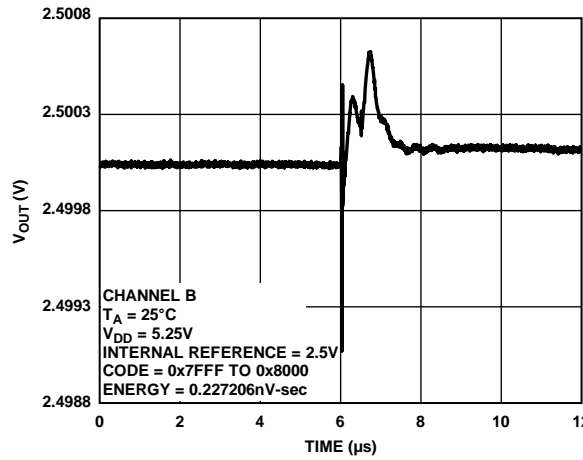

Figure 32. Digital-to-Analog Glitch Impulse

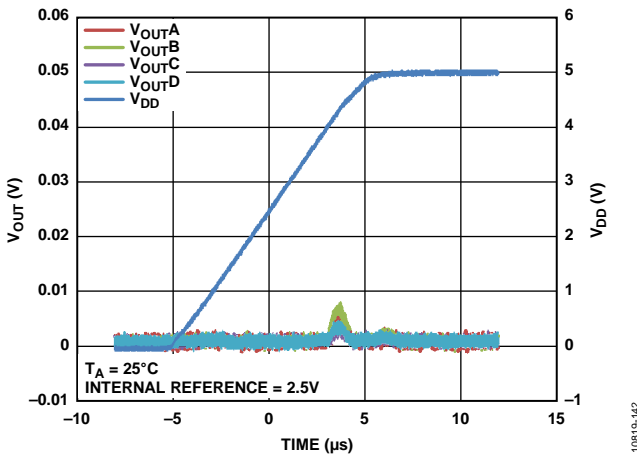

Figure 30. Power-On Reset to 0V

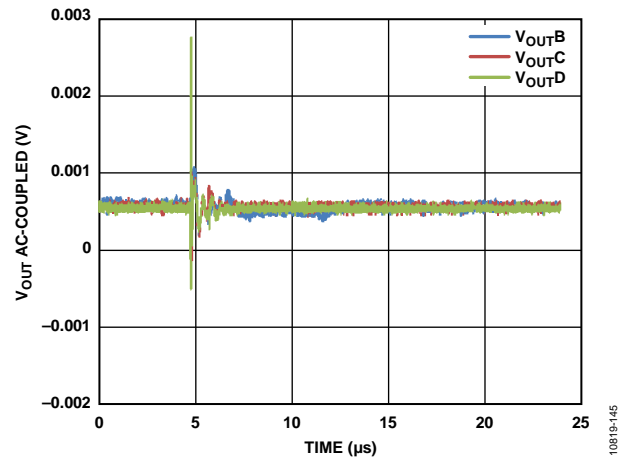

Figure 33. Analog Crosstalk,  $V_{outA}$

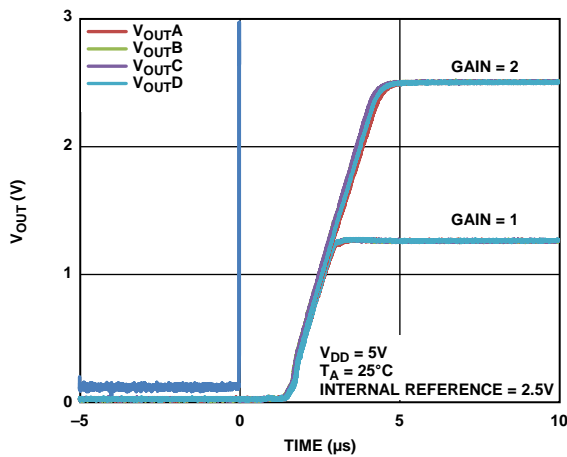

Figure 31. Exiting Power-Down to Midscale

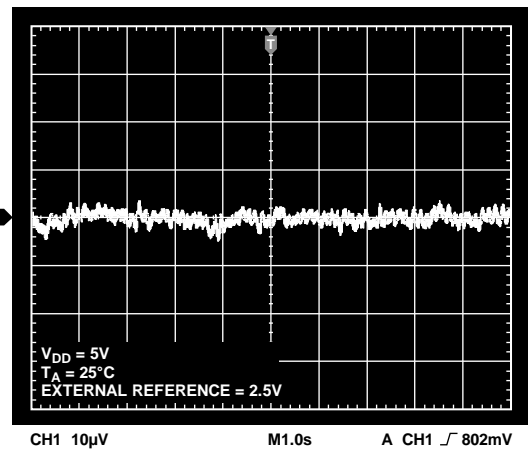

Figure 34. 0.1 Hz to 10 Hz Output Noise Plot, 2.5 V External Reference

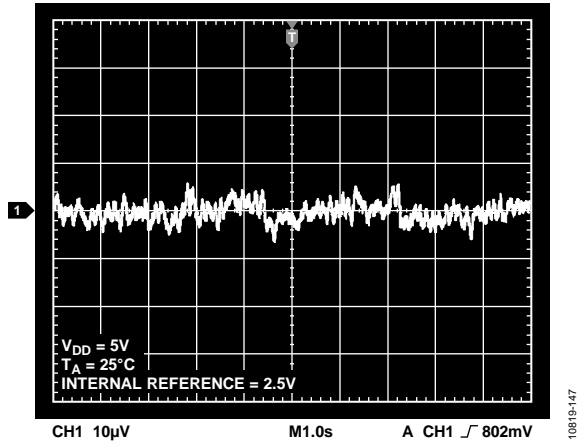

Figure 35. 0.1 Hz to 10 Hz Output Noise Plot, 2.5 V Internal Reference

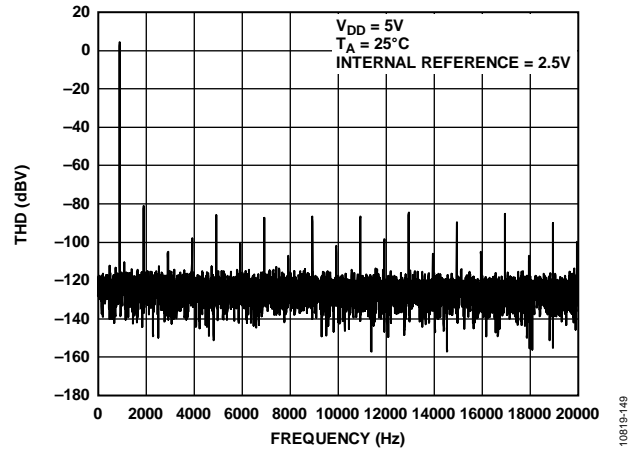

Figure 37. Total Harmonic Distortion at 1 kHz

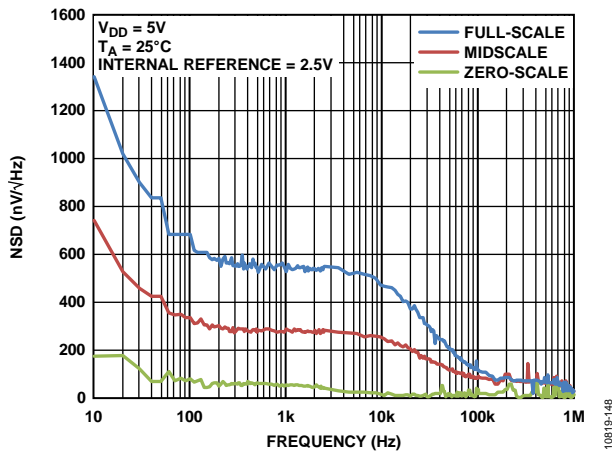

Figure 36. Noise Spectral Density

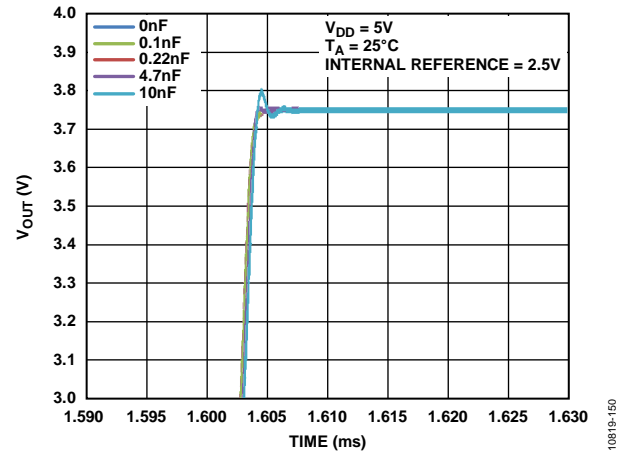

Figure 38. Settling Time vs. Capacitive Load

## TERMINOLOGY

### Relative Accuracy or Integral Nonlinearity (INL)

Relative accuracy or integral nonlinearity is a measurement of the maximum deviation, in LSBs, from a straight line passing through the endpoints of the DAC transfer function. Figure 11 shows a typical INL vs. code plot.

### Differential Nonlinearity (DNL)

Differential nonlinearity is the difference between the measured change and the ideal 1 LSB change between any two adjacent codes. A specified differential nonlinearity of  $\pm 1$  LSB maximum ensures monotonicity. The AD5316R is guaranteed monotonic by design. Figure 12 shows a typical DNL vs. code plot.

### Zero-Code Error

Zero-code error is a measurement of the output error when zero code (0x0000) is loaded to the DAC register. Ideally, the output should be 0 V. The zero-code error is always positive in the AD5316R because the output of the DAC cannot go below 0 V due to a combination of the offset errors in the DAC and the output amplifier. Zero-code error is expressed in mV. Figure 17 shows a plot of zero-code error vs. temperature.

### Full-Scale Error

Full-scale error is a measurement of the output error when full-scale code (0xFFFF) is loaded to the DAC register. Ideally, the output should be  $V_{DD} - 1$  LSB. Full-scale error is expressed as a percentage of the full-scale range (% of FSR). Figure 16 shows a plot of full-scale error vs. temperature.

### Gain Error

Gain error is a measurement of the span error of the DAC. It is the deviation in slope of the DAC transfer characteristic from the ideal expressed in % of FSR.

### Gain Temperature Coefficient

Gain temperature coefficient is a measurement of the change in gain error with changes in temperature. It is expressed in ppm of FSR/ $^{\circ}$ C.

### Offset Error

Offset error is a measurement of the difference between  $V_{OUT}$  (actual) and  $V_{OUT}$  (ideal) expressed in mV in the linear region of the transfer function. It can be negative or positive.

### Offset Error Drift

Offset error drift is a measurement of the change in offset error with changes in temperature. It is expressed in  $\mu$ V/ $^{\circ}$ C.

### DC Power Supply Rejection Ratio (PSRR)

DC PSRR indicates how the output of the DAC is affected by changes in the supply voltage. PSRR is the ratio of the change in  $V_{OUT}$  to a change in  $V_{DD}$  for midscale output of the DAC. It is measured in mV/V.  $V_{REF}$  is held at 2.5 V, and  $V_{DD}$  is varied by  $\pm 10\%$ .

### Output Voltage Settling Time

The output voltage settling time is the amount of time it takes for the output of a DAC to settle to a specified level for a  $\frac{1}{4}$  to  $\frac{3}{4}$  full-scale input change.

### Digital-to-Analog Glitch Impulse

Digital-to-analog glitch impulse is the impulse injected into the analog output when the input code in the DAC register changes state. It is normally specified as the area of the glitch in nV-sec, and is measured when the digital input code is changed by 1 LSB at the major carry transition (0x7FFF to 0x8000) (see Figure 32).

### Digital Feedthrough

Digital feedthrough is a measurement of the impulse injected into the analog output of the DAC from the digital inputs of the DAC, but is measured when the DAC output is not updated. It is specified in nV-sec and measured with a full-scale code change on the data bus, that is, from all 0s to all 1s and vice versa.

### Noise Spectral Density (NSD)

Noise spectral density is a measurement of the internally generated random noise. Random noise is characterized as a spectral density (nV/ $\sqrt{\text{Hz}}$ ) and is measured by loading the DAC to mid-scale and measuring noise at the output. It is measured in nV/ $\sqrt{\text{Hz}}$ . Figure 36 shows a plot of noise spectral density.

### DC Crosstalk

DC crosstalk is the dc change in the output level of one DAC in response to a change in the output of another DAC. It is measured with a full-scale output change on one DAC (or soft power-down and power-up) while monitoring another DAC kept at midscale. It is expressed in  $\mu$ V.

DC crosstalk due to load current change is a measurement of the impact that a change in load current on one DAC has on another DAC kept at midscale. It is expressed in  $\mu$ V/mA.

### Digital Crosstalk

Digital crosstalk is the glitch impulse transferred to the output of one DAC at midscale in response to a full-scale code change (all 0s to all 1s and vice versa) in the input register of another DAC. It is expressed in nV-sec.

### Analog Crosstalk

Analog crosstalk is the glitch impulse transferred to the output of one DAC in response to a change in the output of another DAC. To measure analog crosstalk, load one of the input registers with a full-scale code change (all 0s to all 1s and vice versa), and then execute a software LDAC and monitor the output of the DAC whose digital code was not changed. The area of the glitch is expressed in nV-sec.

**DAC-to-DAC Crosstalk**

DAC-to-DAC crosstalk is the glitch impulse transferred to the output of one DAC in response to a digital code change and subsequent analog output change of another DAC. It is measured by loading one channel with a full-scale code change (all 0s to all 1s and vice versa) using the write to and update commands while monitoring the output of another channel that is at mid-scale. The energy of the glitch is expressed in nV-sec.

**Total Harmonic Distortion (THD)**

THD is the difference between an ideal sine wave and its attenuated version using the DAC. The sine wave is used as the reference for the DAC; THD is a measurement of the harmonics present on the DAC output. It is measured in dB.

**Voltage Reference Temperature Coefficient (TC)**

Voltage reference TC is a measurement of the change in the reference output voltage with a change in temperature. The reference TC is calculated using the box method, which defines the TC as the maximum change in the reference output over a given temperature range expressed in ppm/°C, as follows:

$$TC = \left[ \frac{V_{REFmax} - V_{REFmin}}{V_{REFnom} \times TempRange} \right] \times 10^6$$

where:

$V_{REFmax}$  is the maximum reference output measured over the total temperature range.

$V_{REFmin}$  is the minimum reference output measured over the total temperature range.

$V_{REFnom}$  is the nominal reference output voltage, 2.5 V.

$TempRange$  is the specified temperature range of  $-40^{\circ}\text{C}$  to  $+105^{\circ}\text{C}$ .



## THEORY OF OPERATION

### DIGITAL-TO-ANALOG CONVERTER

The AD5316R is a quad, 10-bit, serial input, voltage output DAC with an internal reference. The part operates from supply voltages of 2.7 V to 5.5 V. Data is written to the AD5316R in a 24-bit word format via a 2-wire serial interface. The AD5316R incorporates a power-on reset circuit to ensure that the DAC output powers up to a known output state. The device also has a software power-down mode that reduces the typical current consumption to 1  $\mu$ A.

### TRANSFER FUNCTION

The internal reference is on by default. Because the input coding to the DAC is straight binary, the ideal output voltage when using an external reference is given by

$$V_{OUT} = V_{REF} \times Gain \left[ \frac{D}{2^N} \right]$$

where:

$V_{REF}$  is the value of the external reference.

*Gain* is the gain of the output amplifier and is set to 1 by default. The gain can be set to 1 or 2 using the gain select pin. When the GAIN pin is tied to GND, all four DAC outputs have a span of 0 V to  $V_{REF}$ . When this pin is tied to  $V_{DD}$ , all four DAC outputs have a span of 0 V to  $2 \times V_{REF}$ .

$D$  is the decimal equivalent of the binary code that is loaded to the DAC register (0 to 1023).

$N$  is the DAC resolution (10 bits).

### DAC ARCHITECTURE

The DAC architecture consists of a string DAC followed by an output amplifier. Figure 39 shows a block diagram of the DAC architecture.

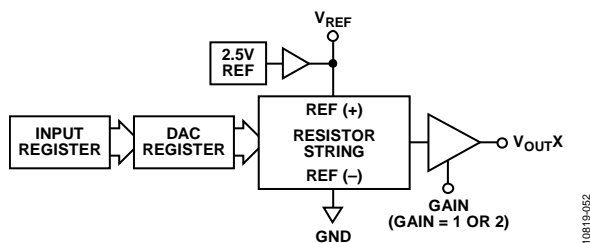

Figure 39. Single DAC Channel Architecture Block Diagram

The resistor string structure is shown in Figure 40. Each resistor in the string has a value  $R$ . The code loaded to the DAC register determines the node on the string from which the voltage is tapped off and fed into the output amplifier. The voltage is tapped off by closing one of the switches that connect the string to the amplifier. Because the AD5316R is a string of resistors, it is guaranteed monotonic.

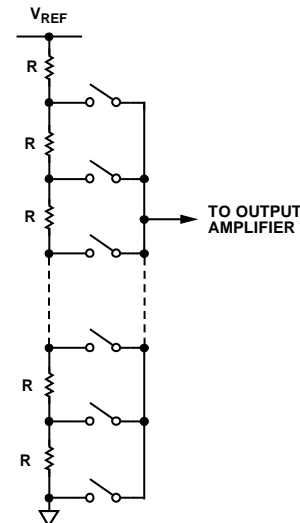

Figure 40. Resistor String Structure

### Internal Reference

The AD5316R on-chip reference is on at power-up but can be disabled via a write to a control register. For more information, see the Internal Reference Setup section.

The 2.5 V, 2 ppm/ $^{\circ}$ C internal reference provides a full-scale output of 2.5 V or 5 V, depending on the state of the GAIN pin. The internal reference is available at the  $V_{REF}$  pin. This buffered reference is capable of driving external loads of up to 10 mA.

### Output Amplifiers

The output buffer amplifier can generate rail-to-rail voltages on its output for an output range of 0 V to  $V_{DD}$ . The actual range depends on the value of  $V_{REF}$ , the GAIN pin, the offset error, and the gain error. The GAIN pin selects the gain of the output.

- When this pin is tied to GND, all four outputs have a gain of 1, and the output range is from 0 V to  $V_{REF}$ .
- When this pin is tied to  $V_{DD}$ , all four outputs have a gain of 2, and the output range is from 0 V to  $2 \times V_{REF}$ .

The output amplifiers are capable of driving a load of 1 k $\Omega$  in parallel with 2 nF to GND. The slew rate is 0.8 V/ $\mu$ s with a  $\frac{1}{4}$  to  $\frac{3}{4}$  scale settling time of 5  $\mu$ s.

**SERIAL INTERFACE**

The AD5316R has a 2-wire, I<sup>2</sup>C-compatible serial interface (see the *I<sup>2</sup>C-Bus Specification*, Version 2.1, January 2000, available from Philips Semiconductor). See Figure 2 for a timing diagram of a typical write sequence. The AD5316R can be connected to an I<sup>2</sup>C bus as a slave device, under the control of a master device. The AD5316R supports standard (100 kHz) and fast (400 kHz) data transfer modes. Support is not provided for 10-bit addressing or general call addressing.

**Input Shift Register**

The input shift register of the AD5316R is 24 bits wide. Data is loaded into the device, MSB first, as a 24-bit word under the control of the serial clock input, SCL. The input shift register consists of an 8-bit command byte and a 16-bit data-word (see Figure 41). The first eight MSBs make up the command byte.

- The first four bits of the command byte are the command bits (C3, C2, C1, and C0), which control the mode of operation of the device (see Table 8).
- The last four bits of the command byte are the address bits (DAC D, DAC C, DAC B, and DAC A), which select the DAC that is operated on by the command (see Table 9).

**Table 8. Command Definitions**

Command Bits				Command
C3	C2	C1	C0	
0	0	0	0	No operation
0	0	0	1	Write to Input Register n (dependent on LDAC)
0	0	1	0	Update DAC Register n with contents of Input Register n
0	0	1	1	Write to and update DAC Channel n
0	1	0	0	Power down/power up DAC
0	1	0	1	Hardware LDAC mask register
0	1	1	0	Software reset (power-on reset)
0	1	1	1	Internal reference setup register
1	X <sup>1</sup>	X <sup>1</sup>	X <sup>1</sup>	Reserved

<sup>1</sup>X = don't care.

**Table 9. Address Bits and Selected DACs**

Address Bits				Selected DAC Channels <sup>1</sup>
DAC D	DAC C	DAC B	DAC A	
0	0	0	1	DAC A
0	0	1	0	DAC B
0	0	1	1	DAC A and DAC B
0	1	0	0	DAC C
0	1	0	1	DAC A and DAC C
0	1	1	0	DAC B and DAC C
0	1	1	1	DAC A, DAC B, and DAC C
1	0	0	0	DAC D
1	0	0	1	DAC A and DAC D
...	...	...	...	...
1	1	1	1	All DACs

<sup>1</sup> Any combination of DAC channels can be selected using the address bits.

The 8-bit command byte is followed by two data bytes, which contain the data-word. The data-word comprises the 10-bit input code, followed by six don't care bits (see Figure 41). The data bits are transferred to the input register on the 24 falling edges of SCL.

Commands can be executed on one DAC channel, any two or three DAC channels, or on all four DAC channels, depending on the address bits selected (see Table 9).

**WRITE AND UPDATE COMMANDS**

For more information about the LDAC function, see the Load DAC (Hardware LDAC Pin) section.

**Write to Input Register n (Dependent on LDAC)**

Command 0001 allows the user to write to each DAC's dedicated input register individually. When LDAC is low, the input register is transparent (if not controlled by the LDAC mask register).

**Update DAC Register n with Contents of Input Register n**

Command 0010 loads the DAC registers/outputs with the contents of the input registers selected by the address bits (see Table 9) and updates the DAC outputs directly.

**Write to and Update DAC Channel n (Independent of LDAC)**

Command 0011 allows the user to write to the DAC registers and update the DAC outputs directly, independent of the state of the LDAC pin.

DB23	DB22	DB21	DB20	DB19	DB18	DB17	DB16	DB15	DB14	DB13	DB12	DB11	DB10	DB9	DB8	DB7	DB6	DB5	DB4	DB3	DB2	DB1	DB0
C3	C2	C1	C0	DAC D	DAC C	DAC B	DAC A	D9	D8	D7	D6	D5	D4	D3	D2	D1	D0	X	X	X	X	X	X
COMMAND				DAC ADDRESS				DAC DATA								DAC DATA							
COMMAND BYTE				DATA HIGH BYTE								DATA LOW BYTE											

Figure 41. Input Shift Register Contents

10816-300

## I<sup>2</sup>C SLAVE ADDRESS

The AD5316R has a 7-bit I<sup>2</sup>C slave address. The five MSBs are 00011 and the two LSBs (A1 and A0) are set by the state of the A1 and A0 address pins. The ability to make hardwired changes to A1 and A0 allows the user to incorporate up to four AD5316R devices on one bus (see Table 10).

**Table 10. Device Address Selection**

A1 Pin Connection	A0 Pin Connection	A1 Bit	A0 Bit
GND	GND	0	0
GND	V <sub>LOGIC</sub>	0	1
V <sub>LOGIC</sub>	GND	1	0
V <sub>LOGIC</sub>	V <sub>LOGIC</sub>	1	1

## SERIAL OPERATION

The 2-wire I<sup>2</sup>C serial bus protocol operates as follows:

1. The master initiates a data transfer by establishing a start condition when a high-to-low transition on the SDA line occurs while SCL is high. The following byte is the address byte, which consists of the 7-bit slave address.
2. The slave device with the transmitted address responds by pulling SDA low during the 9<sup>th</sup> clock pulse (this is called the acknowledge bit). At this stage, all other devices on the bus remain idle while the selected device waits for data to be written to, or read from, its input shift register.

3. Data is transmitted over the serial bus in sequences of nine clock pulses (eight data bits followed by an acknowledge bit). Transitions on the SDA line must occur during the low period of SCL; SDA must remain stable during the high period of SCL.
4. After all data bits are read or written, a stop condition is established. In write mode, the master pulls the SDA line high during the 10<sup>th</sup> clock pulse to establish a stop condition. In read mode, the master issues a no acknowledge for the 9<sup>th</sup> clock pulse (that is, the SDA line remains high). The master then brings the SDA line low before the 10<sup>th</sup> clock pulse and then high again during the 10<sup>th</sup> clock pulse to establish a stop condition.

## WRITE OPERATION

When writing to the AD5316R, the user must begin with a start command followed by an address byte ( $R/\overline{W} = 0$ ), after which the DAC acknowledges that it is prepared to receive data by pulling SDA low. The AD5316R requires two bytes of data for the DAC and a command byte that controls various DAC functions. Three bytes of data must, therefore, be written to the DAC with the command byte followed by the most significant data byte and the least significant data byte, as shown in Figure 42. All these data bytes are acknowledged by the AD5316R. A stop condition follows.

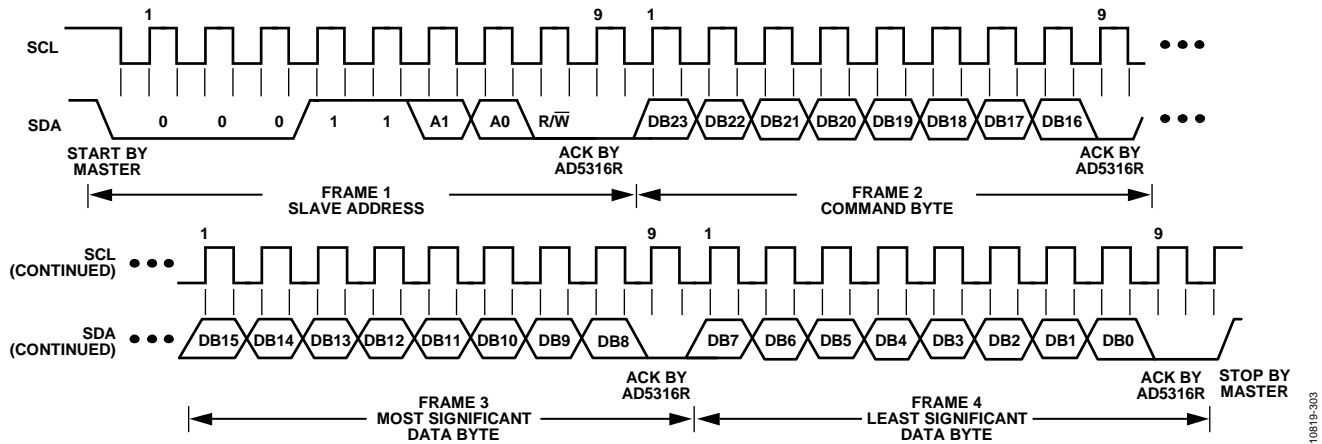

**READ OPERATION**

When reading data back from the AD5316R, the user must begin with a start command followed by an address byte ( $R/\overline{W} = 0$ ), after which the DAC acknowledges that it is prepared to receive data by pulling SDA low. The address byte must be followed by the command byte, which determines both the read command that is to follow and the pointer address to read from; the command byte is also acknowledged by the DAC. The user configures the channel to read back the contents of one or more DAC registers and sets the readback command to active using the command byte. Following this, the master establishes a repeated start condition, and the address is reset with  $R/\overline{W} = 1$ . This byte is acknowledged by the DAC, indicating that it is prepared to transmit data. Two bytes of data are then read from the DAC, as shown in Figure 43. A NACK condition from the master, followed by a stop condition, completes the read sequence. If more than one DAC is selected, Channel A is read back by default.

Following this, the master establishes a repeated start condition, and the address is reset with  $R/\overline{W} = 1$ . This byte is acknowledged by the DAC, indicating that it is prepared to transmit data. Two bytes of data are then read from the DAC, as shown in Figure 43. A NACK condition from the master, followed by a stop condition, completes the read sequence. If more than one DAC is selected, Channel A is read back by default.

**MULTIPLE DAC READBACK SEQUENCE**

When reading data back from multiple AD5316R DACs, the user begins with an address byte ( $R/\overline{W} = 0$ ), after which the DAC acknowledges that it is prepared to receive data by pulling SDA low. The address byte must be followed by the command byte, which is also acknowledged by the DAC. The user selects the first channel to read back using the command byte. Following this, the master establishes a repeated start condition, and the address is reset with  $R/\overline{W} = 1$ . This byte is acknowledged by the DAC, indicating that it is prepared to transmit data. The first two bytes of data are then read from DAC Input Register n (selected using the command byte), most significant byte first, as shown in Figure 43. The next two bytes read back are the contents of DAC Input Register n + 1, and the next bytes read back are the contents of DAC Input Register n + 2. Data is read from the DAC input registers in this auto-incremented fashion until a NACK followed by a stop condition follows. If the contents of DAC Input Register D are read out, the next two bytes of data that are read are the contents of DAC Input Register A.

Following this, the master establishes a repeated start condition, and the address is reset with  $R/\overline{W} = 1$ . This byte is acknowledged by the DAC, indicating that it is prepared to transmit data. The first two bytes of data are then read from DAC Input Register n (selected using the command byte), most significant byte first, as shown in Figure 43. The next two bytes read back are the contents of DAC Input Register n + 1, and the next bytes read back are the contents of DAC Input Register n + 2. Data is read from the DAC input registers in this auto-incremented fashion until a NACK followed by a stop condition follows. If the contents of DAC Input Register D are read out, the next two bytes of data that are read are the contents of DAC Input Register A.

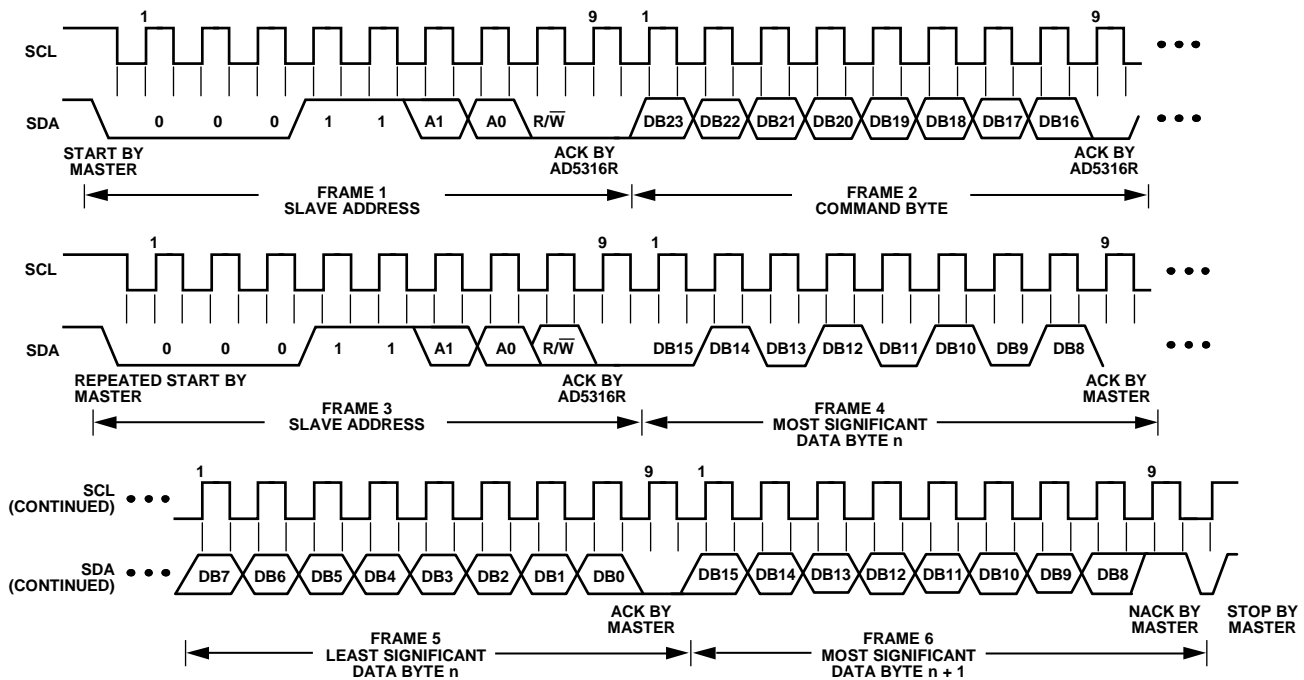

Figure 43. I<sup>2</sup>C Read Operation

10819-304

**POWER-DOWN OPERATION**

Command 0100 is designated for the power-down function. The AD5316R provides three separate power-down modes (see Table 11). These power-down modes are software programmable by setting Bit DB7 to Bit DB0 in the input shift register (see Table 12). Two bits are associated with each DAC channel. Table 11 shows how the state of these two bits corresponds to the mode of operation of the device.

**Table 11. Modes of Operation**

Operating Mode	PDx1	PDx0
Normal Operation	0	0
Power-Down Modes		
1 kΩ to GND	0	1
100 kΩ to GND	1	0
Three-State	1	1

Any or all DACs (DAC A to DAC D) can be powered down to the selected mode by setting the corresponding bits in the input shift register. See Table 12 for the contents of the input shift register during the power-down/power-up operation.

When both Bit PDx1 and Bit PDx0 (where x is the DAC selected) in the input shift register are set to 0, the part works normally with its normal power consumption of 1.1 mA at 5 V. When Bit PDx1, Bit PDx0, or both Bit PDx1 and Bit PDx0 are set to 1, the part is in power-down mode. In power-down mode, the supply current falls to 4 μA at 5 V.

In power-down mode, the output stage is internally switched from the output of the amplifier to a resistor network of known values. In this way, the output impedance of the part is known when the part is in power-down mode.

Table 11 lists the three power-down options. The output is connected internally to GND through either a 1 kΩ or a 100 kΩ resistor, or it is left open-circuited (three-state). The output stage is illustrated in Figure 44.

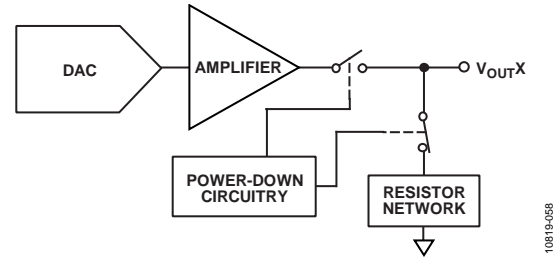

Figure 44. Output Stage During Power-Down

The bias generator, output amplifier, resistor string, and other associated linear circuitry are shut down when power-down mode is activated. However, the contents of the DAC registers are unaffected in power-down mode, and the DAC registers can be updated while the device is in power-down mode. The time required to exit power-down is typically 2.5 μs for V<sub>DD</sub> = 5 V.

To reduce the current consumption further, the on-chip reference can be powered off (see the Internal Reference Setup section).

**LOAD DAC (HARDWARE LDAC PIN)**

The AD5316R DAC has double buffered interfaces consisting of two banks of registers: input registers and DAC registers. The user can write to any combination of the input registers (see Table 9). Updates to the DAC registers are controlled by the LDAC pin.

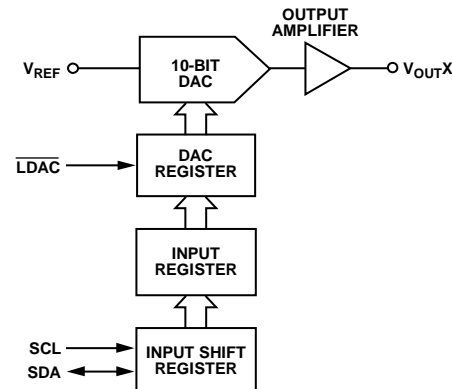

Figure 45. Simplified Diagram of Input Loading Circuitry for a Single DAC

**Table 12. 24-Bit Input Shift Register Contents for Power-Down/Power-Up Operation<sup>1</sup>**

DB23 (MSB)	DB22	DB21	DB20	DB19 to DB16	DB15 to DB8	DB7	DB6	DB5	DB4	DB3	DB2	DB1	DB0 (LSB)
0	1	0	0	X	X	PDD1	PDD0	PDC1	PDC0	PDB1	PDB0	PDA1	PDA0
Command bits (C3 to C0)				Address bits (don't care)	Don't care	Power-down select, DAC D		Power-down select, DAC C		Power-down select, DAC B		Power-down select, DAC A	

<sup>1</sup> X = don't care.

**Instantaneous DAC Updating ( $\overline{\text{LDAC}}$  Held Low)**

For instantaneous updating of the DACs,  $\overline{\text{LDAC}}$  is held low while data is clocked into the input register using Command 0001. Both the addressed input register and the DAC register are updated on the 24<sup>th</sup> clock, and the output begins to change (see Table 14).

**Deferred DAC Updating ( $\overline{\text{LDAC}}$  Pulsed Low)**

For deferred updating of the DACs,  $\overline{\text{LDAC}}$  is held high while data is clocked into the input register using Command 0001. All DAC outputs are asynchronously updated by pulling  $\overline{\text{LDAC}}$  low after the 24<sup>th</sup> clock. The update occurs on the falling edge of  $\overline{\text{LDAC}}$ .

**LDAC MASK REGISTER**

Command 0101 is reserved for the software  $\overline{\text{LDAC}}$  function. When this command is executed, the address bits are ignored. When writing to the DAC using Command 0101, the 4-bit  $\overline{\text{LDAC}}$  mask register (DB3 to DB0) is loaded. Bit DB3 of the  $\overline{\text{LDAC}}$  mask register corresponds to DAC D; Bit DB2 corresponds to DAC C; Bit DB1 corresponds to DAC B; and Bit DB0 corresponds to DAC A.

The default value of these bits is 0; that is, the  $\overline{\text{LDAC}}$  pin works normally. Setting any of these bits to 1 forces the selected DAC channel to ignore transitions on the  $\overline{\text{LDAC}}$  pin, regardless of the state of the hardware  $\overline{\text{LDAC}}$  pin. This flexibility is useful in applications where the user wishes to select which channels respond to the  $\overline{\text{LDAC}}$  pin.

The  $\overline{\text{LDAC}}$  mask register allows the user extra flexibility and control over the hardware  $\overline{\text{LDAC}}$  pin (see Table 13). Setting the  $\overline{\text{LDAC}}$  bit (DB3 to DB0) to 0 for a DAC channel allows the hardware  $\overline{\text{LDAC}}$  pin to control the updating of that channel.

**Table 13.  $\overline{\text{LDAC}}$  Overwrite Definition**

Load $\overline{\text{LDAC}}$ Register		$\overline{\text{LDAC}}$ Operation
$\overline{\text{LDAC}}$ Bit (DB3 to DB0)	$\overline{\text{LDAC}}$ Pin	
0	1 or 0	Determined by the $\overline{\text{LDAC}}$ pin.
1	X <sup>1</sup>	DAC channels are updated. (DAC channels see $\overline{\text{LDAC}}$ pin as 1.)

<sup>1</sup> X = don't care.

**HARDWARE RESET PIN ( $\overline{\text{RESET}}$ )**

$\overline{\text{RESET}}$  is an active low reset that allows the outputs to be cleared to either zero scale or midscale. The clear code value is user selectable via the reset select pin (RSTSEL). It is necessary to keep  $\overline{\text{RESET}}$  low for a minimum of 30 ns to complete the operation.

When the  $\overline{\text{RESET}}$  signal is returned high, the output remains at the cleared value until a new value is programmed. The outputs cannot be updated with a new value while the  $\overline{\text{RESET}}$  pin is low.

There is also a software executable reset function that resets the DAC to the power-on reset code. Command 0110 is designated for this software reset function (see Table 8). Any events on  $\overline{\text{LDAC}}$  or  $\overline{\text{RESET}}$  during power-on reset are ignored.

**RESET SELECT PIN (RSTSEL)**

The AD5316R contains a power-on reset circuit that controls the output voltage during power-up. When the RSTSEL pin is tied to GND, the outputs power up to zero scale (note that this is outside the linear region of the DAC). When the RSTSEL pin is tied to  $V_{DD}$ , the outputs power up to midscale. The outputs remain powered up at the level set by the RSTSEL pin until a valid write sequence is made to the DAC.

**Table 14. Write Commands and  $\overline{\text{LDAC}}$  Pin Truth Table<sup>1</sup>**

Command	Description	Hardware $\overline{\text{LDAC}}$ Pin State	Input Register Contents	DAC Register Contents
0001	Write to Input Register n (dependent on $\overline{\text{LDAC}}$ )	$V_{\text{LOGIC}}$	Data update	No change (no update)
		GND <sup>2</sup>	Data update	Data update
0010	Update DAC Register n with contents of Input Register n	$V_{\text{LOGIC}}$	No change	Updated with input register contents
		GND	No change	Updated with input register contents
0011	Write to and update DAC Channel n	$V_{\text{LOGIC}}$	Data update	Data update
		GND	Data update	Data update

<sup>1</sup> A high to low transition on the hardware  $\overline{\text{LDAC}}$  pin always updates the contents of the DAC register with the contents of the input register on channels that are not masked (blocked) by the  $\overline{\text{LDAC}}$  mask register.

<sup>2</sup> When the  $\overline{\text{LDAC}}$  pin is permanently tied low, the  $\overline{\text{LDAC}}$  mask bits are ignored.

**INTERNAL REFERENCE SETUP**

By default, the internal reference is on at power-up. To reduce the supply current, the on-chip reference can be turned off. Command 0111 is reserved for setting up the internal reference. To turn off the internal reference, set the software programmable bit, DB0, in the input shift register using Command 0111, as shown in Table 16. Table 15 shows how the state of the DB0 bit corresponds to the mode of operation.

**Table 15. Internal Reference Setup Register**

Internal Reference Setup Register (Bit DB0)	Action
0	Reference on (default)
1	Reference off

**SOLDER HEAT REFLOW**

As with all IC reference voltage circuits, the reference value experiences a shift induced by the soldering process. Analog Devices, Inc., performs a reliability test called precondition to mimic the effect of soldering a device to a board. The output voltage specification in Table 2 includes the effect of this reliability test.

Figure 46 shows the effect of solder heat reflow (SHR) as measured through the reliability test (precondition).

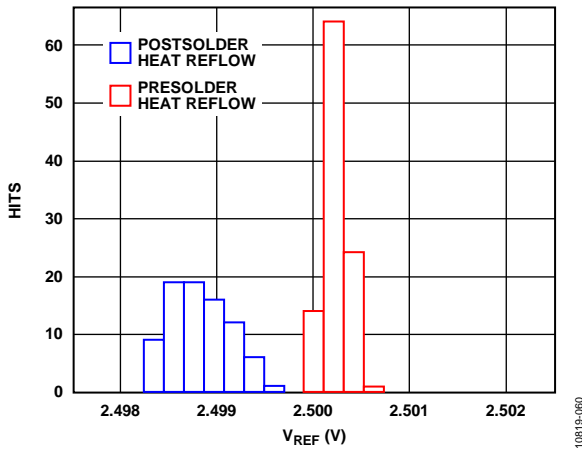

Figure 46. SHR Reference Voltage Shift

**THERMAL HYSTERESIS**

Thermal hysteresis is the voltage difference induced on the reference voltage by sweeping the temperature from ambient to cold, then to hot, and then back to ambient.

Thermal hysteresis data is shown in Figure 47. It is measured by sweeping the temperature from ambient to  $-40^{\circ}\text{C}$ , then to  $+105^{\circ}\text{C}$ , and then back to ambient. The  $V_{\text{REF}}$  delta is then measured between the two ambient measurements (shown in blue in Figure 47). The same temperature sweep and measurements were immediately repeated, and the results are shown in red in Figure 47.

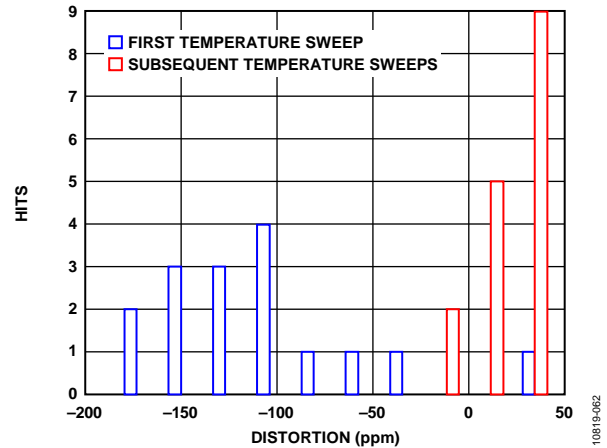

Figure 47. Thermal Hysteresis

**Table 16. 24-Bit Input Shift Register Contents for Internal Reference Setup Command<sup>1</sup>**

DB23 (MSB)	DB22	DB21	DB20	DB19 to DB16	DB15 to DB1	DB0 (LSB)
0	1	1	1	X	X	1 or 0
Command bits (C3 to C0)				Address bits (don't care)		Reference setup register

<sup>1</sup>X = don't care.

## APPLICATIONS INFORMATION

### MICROPROCESSOR INTERFACING

Microprocessor interfacing to the AD5316R is via a serial bus that uses a standard protocol that is compatible with DSP processors and microcontrollers. The communications channel requires a 2-wire interface consisting of a clock signal and a data signal.

### AD5316R TO ADSP-BF531 INTERFACE

The I<sup>2</sup>C interface of the AD5316R is designed for easy connection to industry-standard DSPs and microcontrollers. Figure 48 shows the AD5316R connected to the Analog Devices Blackfin<sup>®</sup> processor. The Blackfin processor has an integrated I<sup>2</sup>C port that can be connected directly to the I<sup>2</sup>C pins of the AD5316R.

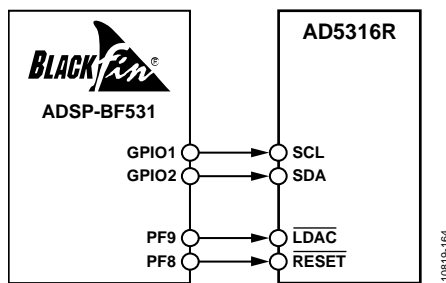

Figure 48. AD5316R to ADSP-BF531 Interface

### LAYOUT GUIDELINES

In any circuit where accuracy is important, careful consideration of the power supply and ground return layout helps to ensure the rated performance. The PCB on which the AD5316R is mounted should be designed so that the AD5316R lies on the analog plane.

The AD5316R should have ample supply bypassing of 10  $\mu$ F in parallel with 0.1  $\mu$ F on each supply, located as close to the package as possible, ideally right up against the device. The 10  $\mu$ F capacitor is the tantalum bead type. The 0.1  $\mu$ F capacitor should have low effective series resistance (ESR) and low effective series inductance (ESL), such as the common ceramic types; these capacitors provide a low impedance path to ground at high frequencies to handle transient currents due to internal logic switching.

In systems where many devices are on one board, it is often useful to provide some heat sinking capability to allow the power to dissipate easily.

The AD5316R LFCSP models have an exposed pad beneath the device. Connect this pad to the GND supply for the part. For optimum performance, use special considerations to design the motherboard and to mount the package.

For enhanced thermal, electrical, and board level performance, solder the exposed pad on the bottom of the LFCSP package to the corresponding thermal land paddle on the PCB. Design thermal vias into the PCB land paddle area to further improve heat dissipation.

The GND plane on the device can be increased (as shown in Figure 49) to provide a natural heat sinking effect.

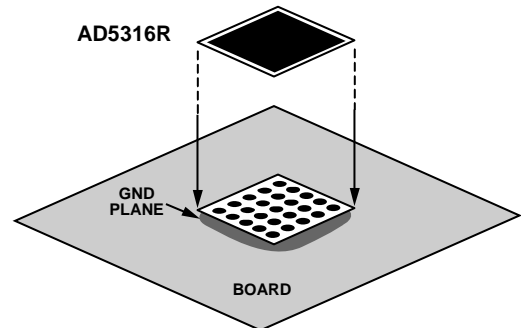

Figure 49. Paddle Connection to Board

### GALVANICALLY ISOLATED INTERFACE

In many process control applications, it is necessary to provide an isolation barrier between the controller and the unit being controlled to protect and isolate the controlling circuitry from any hazardous common-mode voltages that may occur.

The Analog Devices iCoupler<sup>®</sup> products provide voltage isolation in excess of 2.5 kV. The serial loading structure of the AD5316R makes the part ideal for isolated interfaces because the number of interface lines is kept to a minimum. Figure 50 shows a 4-channel isolated interface to the AD5316R using the ADuM1400. For more information, visit <http://www.analog.com/icouplers>.

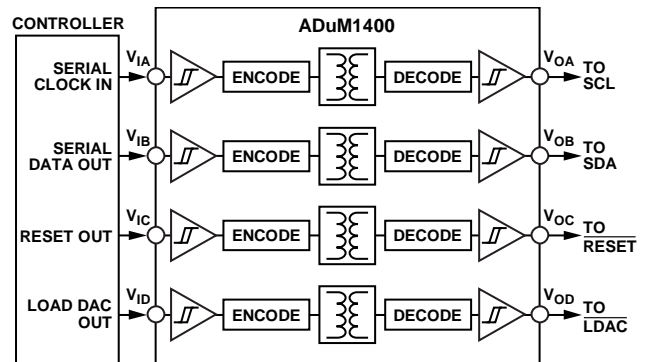
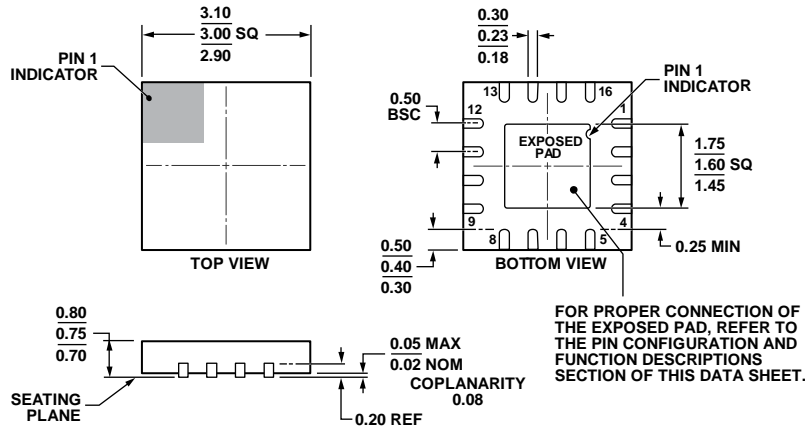

Figure 50. Isolated Interface



OUTLINE DIMENSIONS



COMPLIANT TO JEDEC STANDARDS MO-220-WEED-6.

Figure 51. 16-Lead Lead Frame Chip Scale Package [LFCSP\_WQ]  
3 mm x 3 mm Body, Very Very Thin Quad  
(CP-16-22)  
Dimensions shown in millimeters

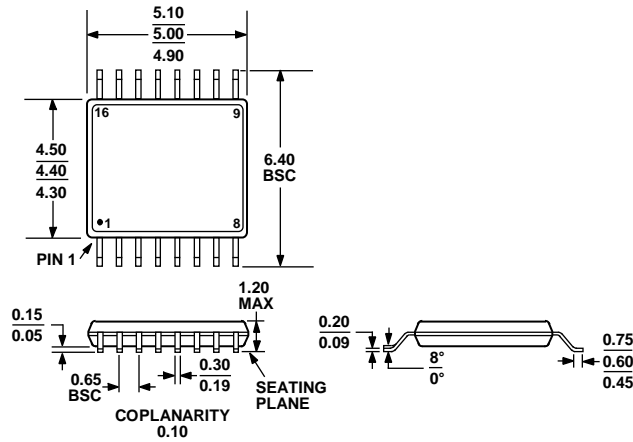

COMPLIANT TO JEDEC STANDARDS MO-153-AB

Figure 52. 16-Lead Thin Shrink Small Outline Package [TSSOP]  
(RU-16)  
Dimensions shown in millimeters

ORDERING GUIDE

Model <sup>1</sup>	Resolution	Temperature Range	Accuracy (INL)	Reference Tempco (ppm/°C)	Package Description	Package Option	Branding
AD5316RBCPZ-RL7	10 Bits	-40°C to +105°C	±0.5 LSB	±5 (max)	16-Lead LFCSP_WQ	CP-16-22	DJT
AD5316RBruz	10 Bits	-40°C to +105°C	±0.5 LSB	±5 (max)	16-Lead TSSOP	RU-16	
AD5316RBruz-RL7	10 Bits	-40°C to +105°C	±0.5 LSB	±5 (max)	16-Lead TSSOP	RU-16	

<sup>1</sup> Z = RoHS Compliant Part.

I<sup>2</sup>C refers to a communications protocol originally developed by Philips Semiconductors (now NXP Semiconductors).