

Dear Valued TRINAMIC Customer,

This notification is to inform you that a change will be done to the product listed below:

- **TMC246A-PA**
- **TMC246A-PA-T**
- **TMC246A-PA-X**

For samples and further questions, please contact your sales partner.

Hardware changes

Due to product maintenance and to assure longevity of the TMC246 we qualified a new wafer fab for TMC246 motor driver MOSFETs full-bridges. Hardware changes:

- Motor driver N-channel MOSFET (4pcs. in total)
- Motor driver P-channel MOSFET (4pcs. in total)
- Revision field of IC label will change from "A" to "B". (TMC246A to TMC246B)
- New motor driver MOSFETs will improve power losses due to lower R_{dson}

You can find the relevant MOSFETs (red marked) in the block diagram in figure 1. Due to the multi-chip structure of the TMC246 only motor driver MOSFET dies are affected to the changes. Complete digital and analog part of the core die as well as lead frame and IC structure stays unchanged.

Compatibility

The new revision of the TMC246 is fully compatible. Notes on hardware compatibility:

- No change in mechanical dimensions. Test passed.
- No change in electrical behavior of digital and analog core die. Test passed.
- MOSFET electrical characteristic (e.g. slope, break before make, R_{dson}) Test passed.
- Improved behavior of motor driver stage due to lower R_{dson} . (Power dissipation lower or equal to revision A)
- Assembly, production of core die and test facility stays unchanged.
- Digital and analog core die stays unchanged.
- Drop-in compatible.

This improvement is classified as a minor change.

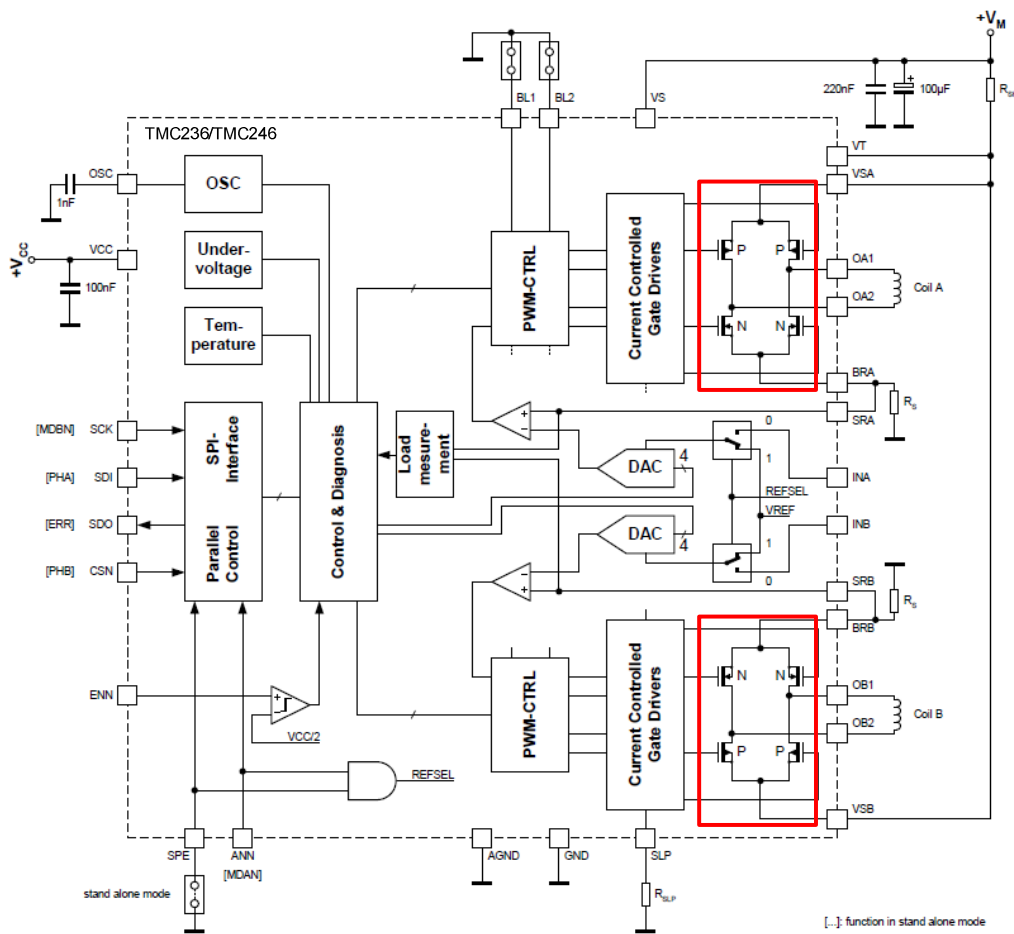

Figure 1: TMC246 block diagram



Product Change Notification

TRINAMIC Motion Control GmbH & Co. KG
Waterloohain 5, 22769 Hamburg, Germany

PCN-2016-06-02

June 2, 2016

www.trinamic.com

Products Affected

Article Name	Affected Article Numbers	NEW Name	NEW Article Numbers
TMC246A-PA	00-0012	TMC246B-PA	00-0120
TMC246A-PA-T	00-0012T	TMC246B-PA-T	00-0120T
TMC246A-PA-X	00-0012X	TMC246B-PA-X	00-0120X

Schedule

Samples of TMC246B-PA are available on request. Please contact your local sales partner.

Trinamic will include changes in new production lots.

Effective date for hardware release	30.09.2016
-------------------------------------	------------

Please note that Trinamic will automatically send new revision TMC246B-PA with end of TMC246A-PA stock.

This PCN notice should be acknowledged within 30 days. Lack of acknowledgement of PCN within 30 days constitutes acceptance of change.