

20W TO220 **OBSOLETE** High Power Resistors

MHP 20

(Combined BI & IRC Datasheets)

- Non-inductive.
- Thermally enhanced Industry standard TO220 package.
- RoHS compliant.
- Low thermal resistance, 5.9 °C/W resistor hot spot to metal tab.
- Complete thermal flow design available for easy implementation.
- Superior vibration durability.
- Small thin package for high density PCB installation.

Applications

- High frequency circuits and high speed pulse designs.
- Switch mode power supplies.
- Motor control and drive circuits.
- Automotive.
- Industrial computing and measurement systems.

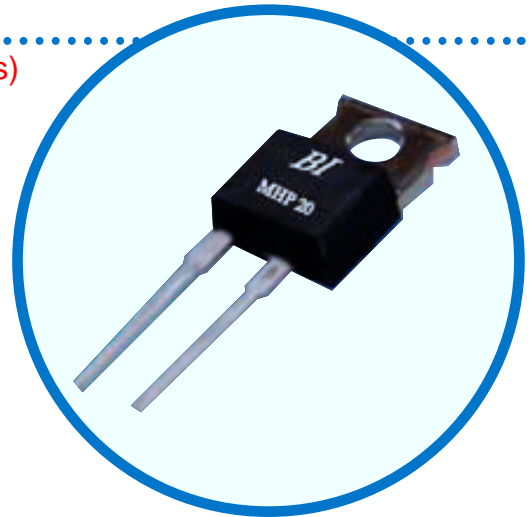

Specifications

Items	Specification			Conditions
Power Rating	20 Watts			-55 to 25 °C flange temperature
Power Rating	1.0 Watts			Free air.
Thermal Resistance	5.9 °C/W			Hot spot to Tab
Resistance Range	0.01-0.09 Ω	0.1-9.1 Ω	10-220 Ω	Up to 51 KΩ also available
Nominal Resistance Series	E6	E24	E24	2.5 Ω and 5.0 Ω also available
TCR	250 ppm/°C	100 ppm/°C	50 ppm/°C	-55 to +155 °C
Tolerance	+/- 5% (J)	5% (J)	+/-1% (F)	
Operation Temp. Range	-55°C to +155°C			
Max. Operating Volt.	500V or √ P.R			
Dielectric Withstanding Voltage	2000 Volts AC			60 seconds.
Load Life	ΔR +/- (1.0 % + 0.05 Ω)			25 °C, 90 min. ON, 30 min. OFF, 1000 hours.
Humidity	ΔR +/- (1.0 % + 0.05 Ω)			40°C, 90-95% RH, DC 0.1 W, 1000 hours.
Temp. Cycle	ΔR +/- (0.25 % + 0.05 Ω)			-55 °C, 30 min., +155 °C, 30 min., 5 cycles
Soldering Heat	ΔR +/- (0.1 % + 0.05 Ω)			250 +/- 5 °C, 3 seconds,
Solder ability	Over 95% of surface			230 +/- 5 °C, 3 seconds.
Insulation Resistance	Over 1,000 MΩ			Between terminals and tab.
Vibration	ΔR +/- (0.25 % + 0.05 Ω)			

General Note

TT electronics reserves the right to make changes in product specification without notice or liability. All information is subject to TT electronics' own data and is considered accurate at time of going to print.

Electrical Performance

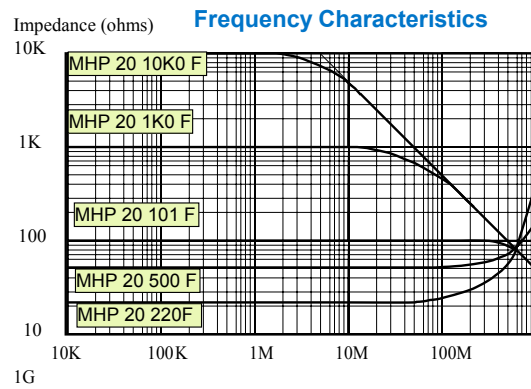
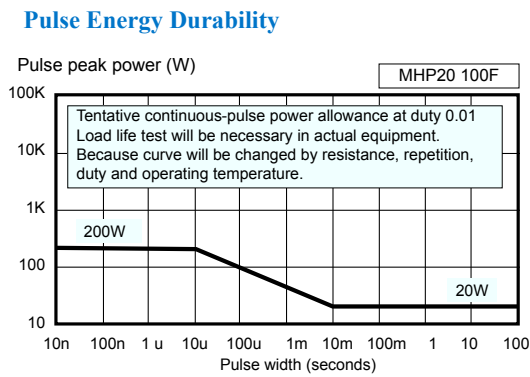
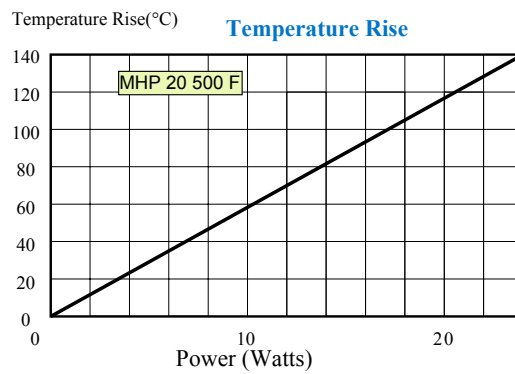
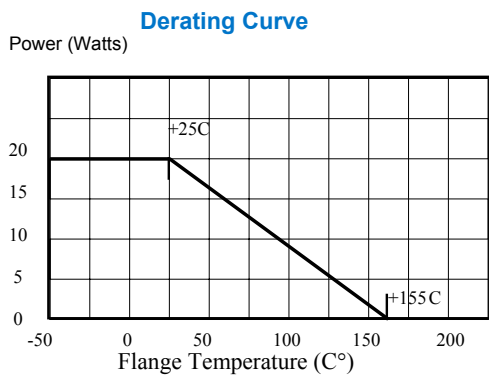

General Note

TT electronics reserves the right to make changes in product specification without notice or liability. All information is subject to TT electronics' own data and is considered accurate at time of going to print.

MHP TO-220 Series

Power Resistor **OBSOLETE**

MHP Series

- TO-220 housing
- Low inductance and capacitance for high frequency circuits
- Available in 20W, 35W, or 50W
- High stability film resistance elements
- RoHS compliant
- Approved to DSCC drawings 07017 and 07018

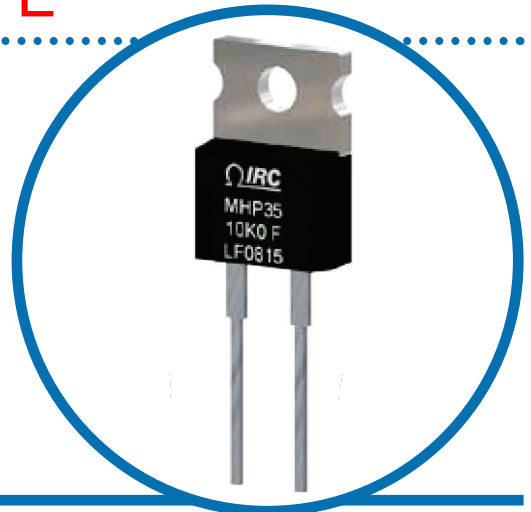

IRC's MHP series resistors satisfy demanding applications for accurate and stable power resistors housed in the convenient TO-220 case. The resistance element is isolated from the mounting tab by an alumina ceramic layer, providing very low thermal resistance and ensuring high insulation resistance between terminals and tab. The non-inductive design makes these products especially useful in high frequency and high speed pulse applications.

Electrical Data

Type	Power Rating ¹		Voltage Rating ⁴	Thermal Resistance	Resistance Range		Tolerances	Nominal Resistance Series ⁵	Typ. TCR (ppm/°C)	Inductance	Capacitance
	Heatsink ²	Free Air ³			Min	Max					
MHP-20	20W	2.25W	500V	5.9°C/W	0.01Ω	0.09Ω	±1%, ±5%	E24 Includes 2.5 & 5.0 multiplier	See Chart	<9nH	<2pF
					0.1Ω	9.1Ω					
					10Ω	51KΩ					
MHP-35	35W	2.25W	500V	3.3°C/W	0.01Ω	0.09Ω	±1%, ±5%	E24 Includes 2.5 & 5.0 multiplier	See Chart	<9nH	<2pF
					0.1Ω	9.1Ω					
					10Ω	51KΩ					
MHP-50	50W	2.25W	500V	2.3°C/W	0.01Ω	0.09Ω	±1%, ±5%	E24 Includes 2.5 & 5.0 multiplier	See Chart	<10nH	<2pF
					0.1Ω	9.1Ω					
					10Ω	51KΩ					

¹Maximum current 25 amps
²Power rating based on 25°C tab temperature
³Power rating based on 25°C ambient temperature
⁴Maximum voltage 500V or $\sqrt{P \times R}$
⁵Contact factory for availability of resistance or tolerance values outside this range

Pulse Energy Durability

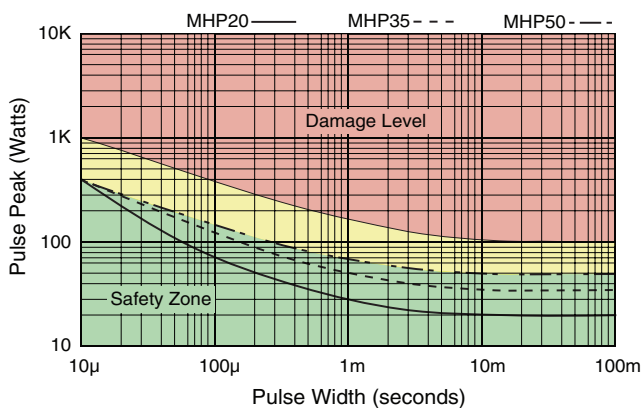

Frequency Characteristics

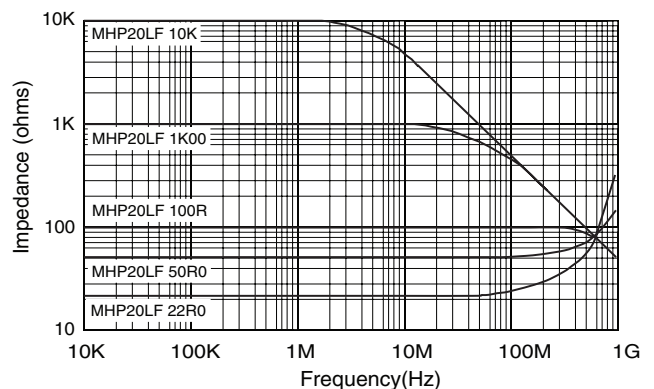

General Note

TT electronics reserves the right to make changes in product specification without notice or liability. All information is subject to TT electronics' own data and is considered accurate at time of going to print.

OBSOLETE

Physical Data

Note: Metal tab is electrically isolated.		Dim	in (nom)	mm
		A	0.398	10.1 ±.2
		B	0.591	15.0 ±0.2
		C	0.177	4.5 ±0.2
		ØD	0.142	3.6 ±0.1
		E	0.610	15.5 ±1.0
		F	0.158	4.0 ±0.5
		G	0.118	3.0 ±0.2
		H	0.108	2.75 ±0.2
		J	0.020	0.5 ±0.05
		K	0.030	0.75 ±0.05
		L	0.059	1.5 ±0.05
		M	0.200	5.08 ±0.1
		N	0.059	1.5 ±0.05
		P	0.630	16.0 ±0.1
Lead Material	Tin Plated Copper			
Tab Material	Nickel Plated Copper			

Environmental Data

Test	Method	Specification - Performance
Thermal Shock	MIL-STD-202 Method 107 Condition F	±0.30% + 50mΩ
Moisture Resistance	MIL-STD-202 Method 106	±1.0% + 50mΩ
Vibration	MIL-STD-202 Method 204 Condition D	±0.25% + 50mΩ
Load Life	MIL-STD-202 Method 108 1,000 Hours	±1.0% + 50mΩ
Resistance to Solder Heat	MIL-STD-202 Method 210 Condition B	±0.25% + 50mΩ
Dielectric Withstanding Voltage	MIL-STD-202 Method 301	2200 volts DC or 1500 volts AC; 60 seconds
Insulation Resistance (between terminal and tab)	MIL-STD-202 Method 302	>1000MΩ
Solderability	MIL-STD-202 Method 208	>95% coverage
Operating Temperature Range		-55°C to +155°C

* During soldering, the soldering temperature profile must not cause the metal tab of this device to exceed 220°C.

General Note

TT electronics reserves the right to make changes in product specification without notice or liability. All information is subject to TT electronics' own data and is considered accurate at time of going to print.

OBSOLETE

Power Derating Data

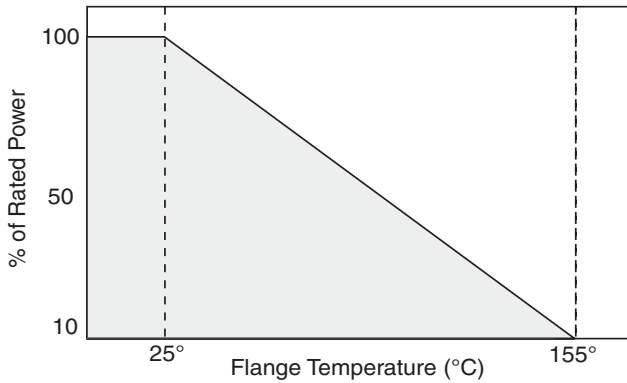

Temperature Rise Data

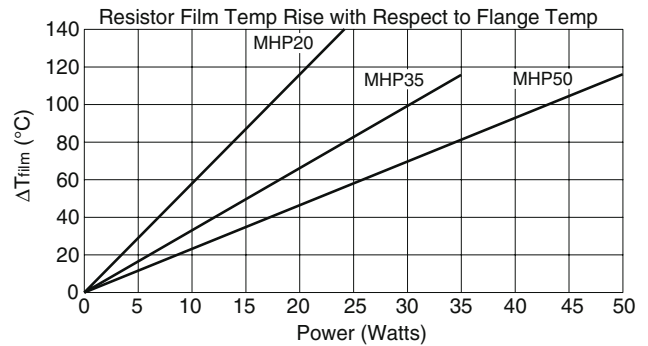

Typical TCR For Low Values

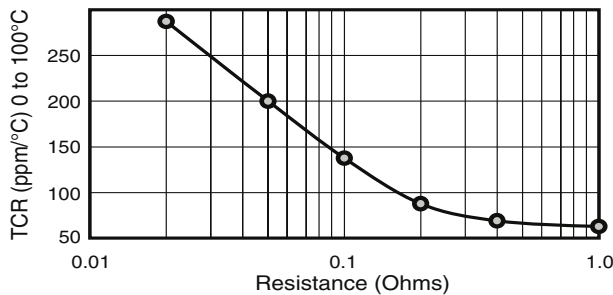

Tube Packaging Data

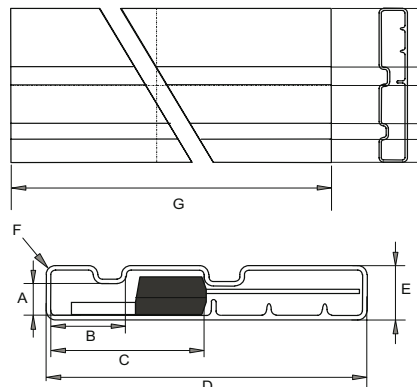

Tube Dimensions		
Dim	Nom. (mm)	Tol. (mm)
A	3.25	0.15
B	8.0	0.15
C	16.25	0.15
D	34.4	(34.0)
E	6.4	(6.0)
F	R0.7	(R0.5)
G	535.0	1.0

Ordering Data

Prefix **TFP** - **MHP20LF** - **1R50** - **J** - **L04**

Style
 MHP20LF = 20W, TO-220 style power resistor
 MHP35LF = 35W, TO-220 style power resistor
 07017 = DSCC drawing (07017) ver. of above
 MHP50LF = 50W, TO-220 style power resistor
 07018 = DSCC drawing (07018) ver. of above

Resistance Code
 4-digit resistance code.
 Ex: 10R0 = 10Ω, 1K00 = 1KΩ

Absolute Tolerance Code
 J = ±5%; F = ±1%

Standard Packaging
 L04 = RoHS compliant tube (50 pcs per tube)

For additional information or to discuss your specific requirements, please contact our Applications Team using the contact details below.

Application Notes:

1. Insulating material is unnecessary between the heat sink and the tab, as the resistor film is isolated by the internal alumina substrate.
2. When mounting with a fastener, thermal grease is recommended.
3. Thermal design should satisfy the following equation: Tab Temperature (T_T) + [Thermal Resistance ($R_{\theta JT}$) x Power applied (Watts)] \leq 155°C over the full operating temperature of the application.
4. Resistor film temperature is not to exceed 155°C during operation.
5. This product is RoHS compliant by exemption according to RoHS directive 2002/95/EC exemptions 5 & 7, as they apply to lead in glass and internal solder connections.

General Note

TT electronics reserves the right to make changes in product specification without notice or liability. All information is subject to TT electronics' own data and is considered accurate at time of going to print.



www.bitechnologies.com www.irctt.com www.welwyn-tt.com