

Wirewound High Surge Resistors

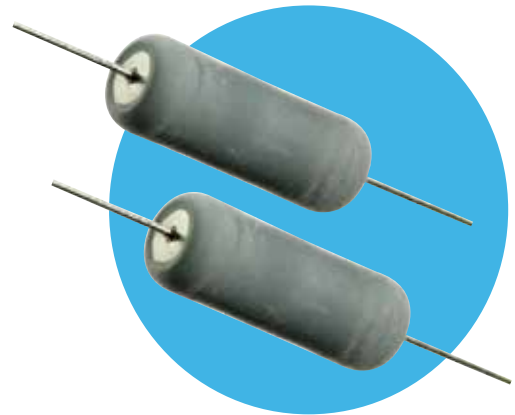

WHS Series

- Enhanced surge & pulse energy capacity
- UL94-V0 flameproof protection
- Radial taped form available
- Surface mount Z-form available
- RoHS compliant with Pb-free terminations
- Non inductive type available

All Pb-free parts comply with EU Directive 2011/65/EU (RoHS2)

Electrical Data

		WHS2	WHS3	WHS5	WHS7	WHS10	WHS10N*
Power rating at 25°C	watts	2	3	5	7	10	
5s overload rating at 25°C	watts	10	15	25	35	50	
Short pulse performance		See Pulse Performance graphs					
Resistance range	ohms	1R0-330R			2R2-330R		5R6-100R
TCR	ppm/°C	±200					
Isolation Voltage	volts	250	350	500	700	1000	
Resistance Tolerance	%	<20R: 5 ≥20R: 1, 2, 5					5%
Standard Values		E24 preferred					
Thermal Impedance	°C/watt	110	82	54	35	25	
Ambient temperature range	°C	-55 to +155					

No Limiting Element Voltage applies to this series; the Rated Voltage is $\sqrt{P \cdot R}$.

*Non inductive (Ayrton Perry) winding

Physical Data

Dimensions (mm) & Weight (g)							
Type	L max	D max	f min	d max	PCB mount centres	Min bend radius	Wt. nom
WHS2	9.0	3.6	19.80	0.81	12.70	1.2	0.50
WHS3	14.5	5.2	24.55		20.30		1.10
WHS5	16.5	7.0	23.55		22.86		1.75
WHS7	25.0	8.8	28.30		31.40		4.40
WHS10	51.0	10.5	26.00	1.01	55.88	1.5	8.80
WHS10N		11.0					10.50

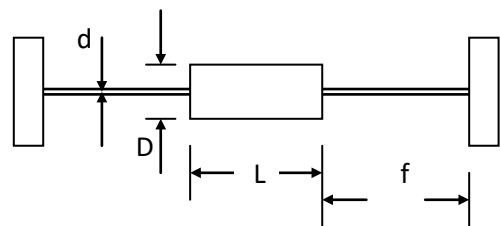

Construction

A high purity ceramic substrate is assembled with interference fit end caps to which are welded the terminations. The resistive element is wound on the substrate and welded to the caps. Flameproof silicone cement coating is applied prior to marking with indelible ink. The components are then leadformed if required and packed.

General Note

TT Electronics reserves the right to make changes in product specification without notice or liability. All information is subject to TT Electronics' own data and is considered accurate at time of going to print.

WHS Series

Terminations

Material: Hot tin dipped copper wire
 Strength: The terminations meet the requirements of IEC 68.2.21
 Solderability: The terminations meet the requirements of IEC 115-1 Clause 4.17.3.2

Marking

WHS2, and WHS3 resistors are marked with four colour bands in conformance with IEC62. The larger sizes are legend marked with type reference, resistance value and tolerance.

Solvent Resistance

The body protection and marking are resistant to all normal industrial cleaning solvents suitable for printed circuits.

Flammability

The resistor coating will not burn or emit incandescent particles under any condition of applied temperature or power overload.

Performance Data

		Maximum	Typical
Load at rated power: 1000hrs @ 25°C	ΔR%	5 +0.001Ω	3
Dry heat: 1000hrs @ 200°C	ΔR%	5 +0.001Ω	3
Short term overload	ΔR%	5 +0.001Ω	1
Derating from rated power @25°C		Zero at 280°C (See Thermal Performance graph).	
Climatic	ΔR%	5 +0.001Ω	2
Climatic category		55/200/56	
TRC & Vibration	ΔR%	5 +0.001Ω	1
Robustness & solder heat	ΔR%	5 +0.001Ω	1
Long term damp heat (56 days)	ΔR%	5 +0.001Ω	1

Pulse Performance

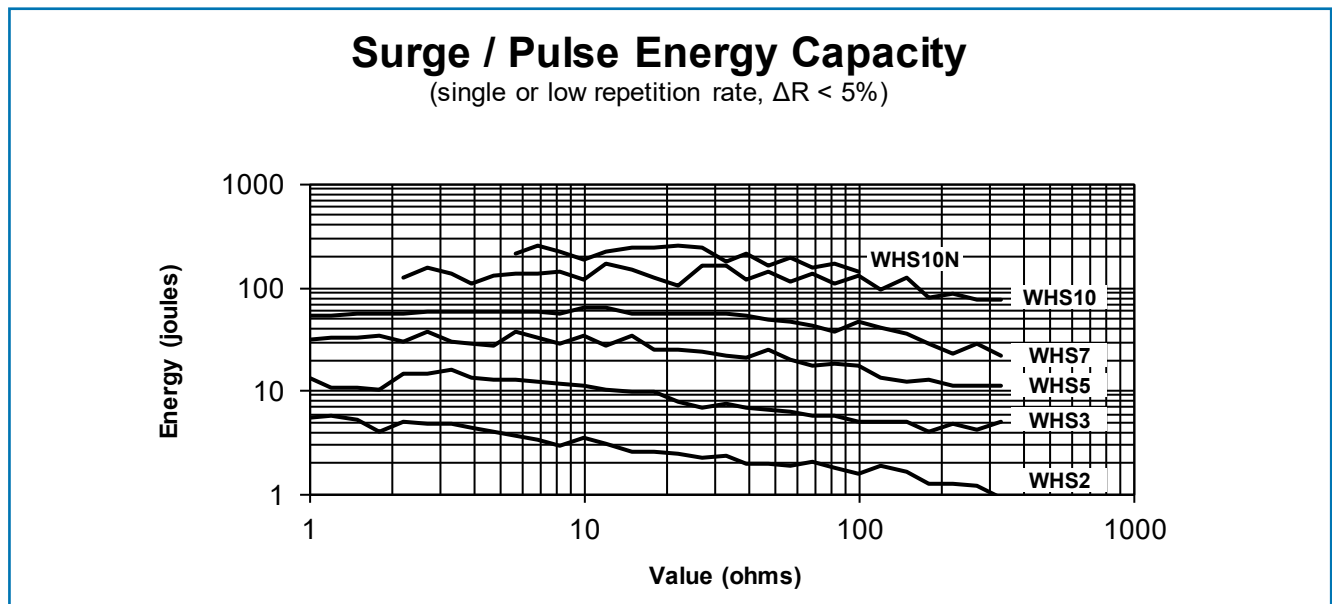

General Note

TT Electronics reserves the right to make changes in product specification without notice or liability. All information is subject to TT Electronics' own data and is considered accurate at time of going to print.

WHS Series

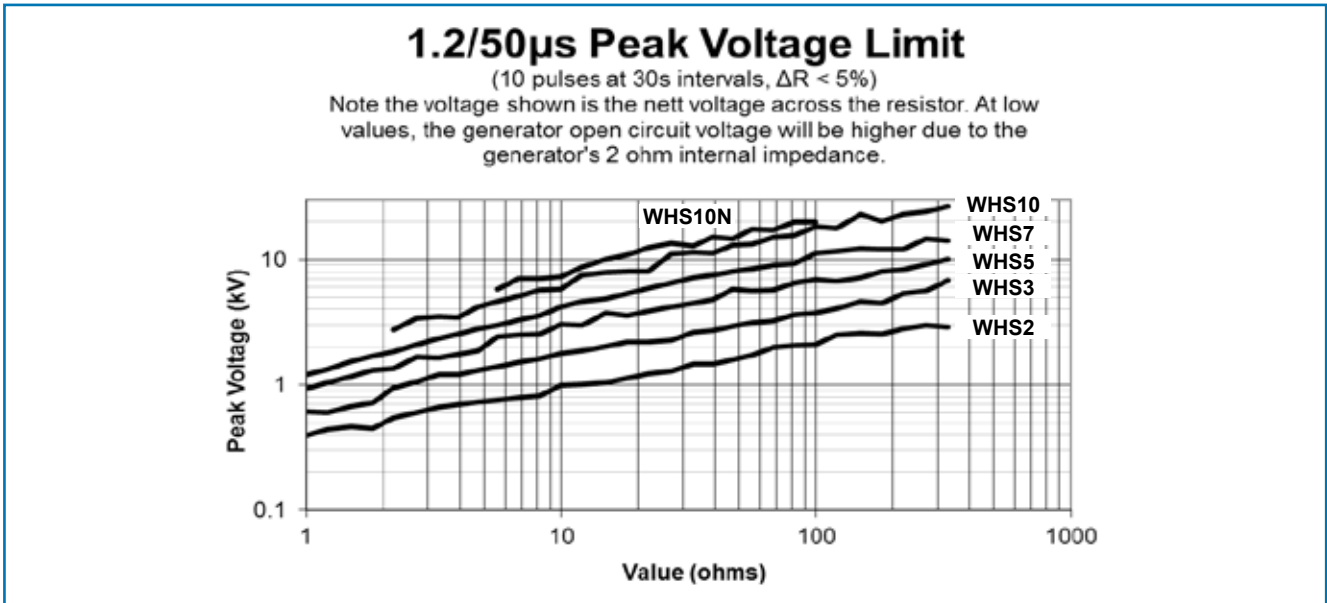

Thermal Performance

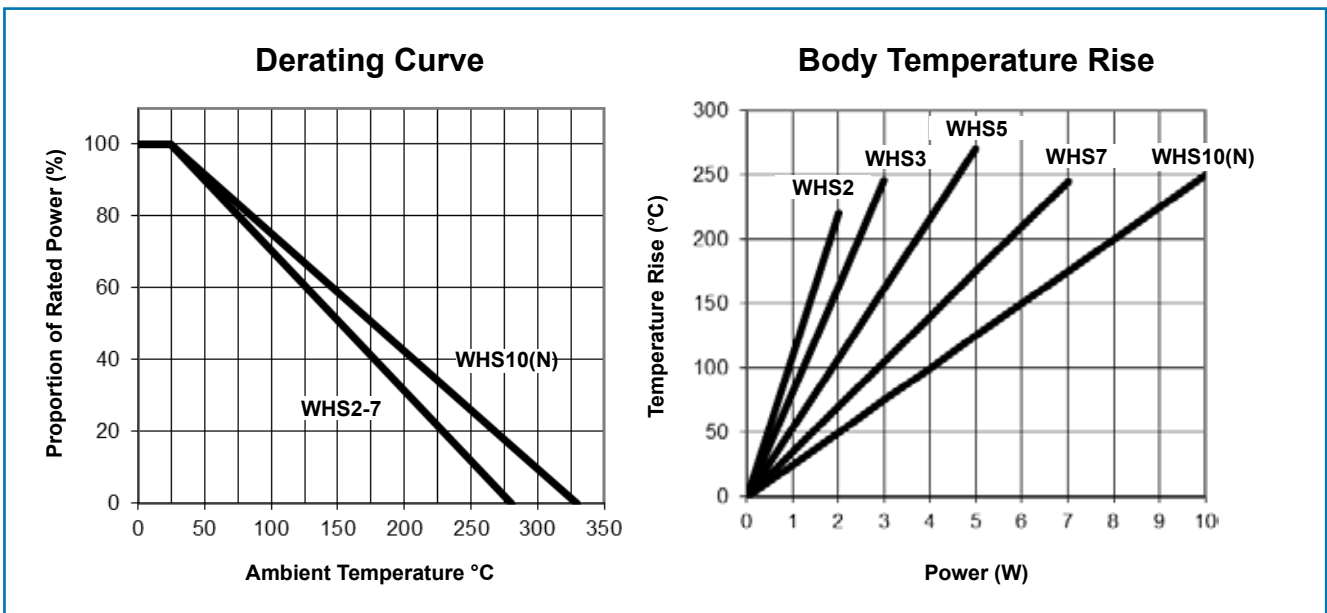

Application Notes

1. If the resistors are to dissipate full rated power, it is recommended that the terminations should not be soldered closer than 4mm from the body.
2. Due to operating temperature limits imposed by some PCB materials, derating may be necessary. The surface temperature rise at the centre of the body is shown under Thermal Performance.
3. WHS2, WHS3, WHS5 resistors can also be supplied with goalpost or lancet pre-formed leads. Hairpin form is available on WHS2 and WHS3 only.

WHS2, WHS3, and WHS5 are also available in an SMD format with ZI formed leads and packed in blister tape. See the ZI-form datasheet for details <http://www.ttelectronicsresistors.com/datasheets/ZI-form.pdf>

General Note

TT Electronics reserves the right to make changes in product specification without notice or liability. All information is subject to TT Electronics' own data and is considered accurate at time of going to print.

WHS Series

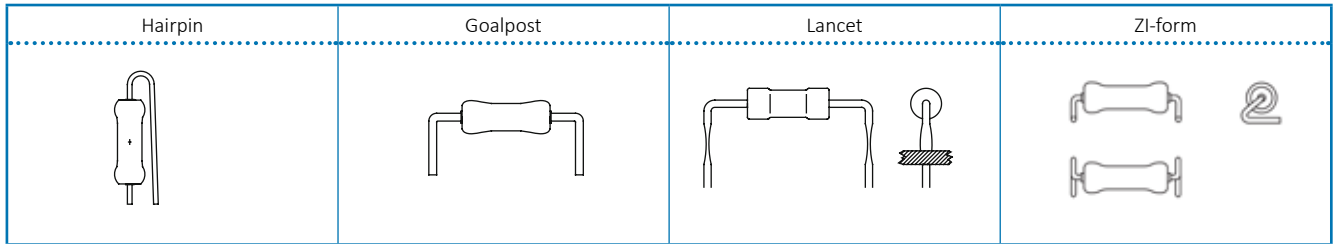

Packaging

The standard packaging for WHS is taped. The critical dimensions are shown in Figure 1. The component wires will not protrude beyond the outside edge of the tapes. Taped product is then packed into boxes or onto reels. See Ordering Procedure for details. Alternative packaging is available by request. Pre-formed resistors are supplied loose packed in plastic bags or boxes.

Dimensions mm	a	b	c
WHS2	6	52	5
WHS3	6	67	10
WHS5	6	63	10
*WHS7	6	85	10
WHS10	9	105	10
WHS10N	9	105	20

*An offset lead length is available for WHS7 series. Consult factory for details

$\text{Body location } f1-f2 \leq 1.4\text{mm}$

Ordering Procedure

Example: WHS2 at 100 ohms and 5% tolerance in ammo pack box of 2500 pieces-

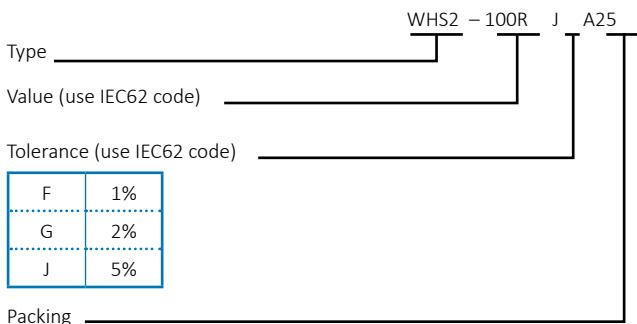

A25	Ammo	WHS2	2500/box	Standard
A1	Ammo	WHS3	1000/box	
T075	Tape	WHS5	750/reel	
T07		WHS7	700/reel	
A02	Ammo	WHS10	200/box	
A01		WHS10N	100/box	

General Note

TT Electronics reserves the right to make changes in product specification without notice or liability. All information is subject to TT Electronics' own data and is considered accurate at time of going to print.