

TENMA[®]

72-10465

Operating Manual



LCR Meter





72-10465 OPERATING MANUAL

Contents

I. General Characteristics and Safety Notices	1
II. Ambient Conditions	4
III. Function Characteristics	4
IV. Instructions of Impedance Parameters	5
V. Measurement Mode	7
VI. LCD Display Instructions	9
VII. Front Panel	11
VIII. Guidelines	12
IX. Fast Applications	22
X. PC Communication Protocol	27
XI. Technical Indicators	27
XII. Battery Replacement	32
XIII. Maintenance	33

I. General Characteristics and Safety Notice

The 72-10465 LCR meter features an easy to read dual display measurement of 19999/1999. It also has serial and parallel measurement modes which can be used to select quality factor, loss factor, phase location angle, and equivalent resistance of measure articles. Intelligent detection and five different test frequencies enable accurate readings for all sizes of capacitors and inductors. The user can also access the stored data on a PC with the included USB connection and interface software. The compact size and case make this unit far more portable than a benchtop meter.

Measurement range and precision

L:20mH ---2000H Best accuracy (0.5%+5) ;
 C:200pF---20mF Best accuracy (0.5%+5) ;
 R:20Ω ----200MΩ Best accuracy (0.3%+5) ;

Impedance/frequency	DCR	100/120Hz	1kHz	10kHz	100kHz
0.1-1	1.0%	1.0%	1.0%	1.0%	1.0%
1-10	0.5%	0.5%	0.5%	0.5%	0.5%
10-100k	0.3%	0.3%	0.3%	0.5%	0.3%
100k-1M	0.5%	0.5%	0.5%	1%	
1M-20M	1.0%	1.0%	1.0%		
20M-200M	2.0%	2.0%	5.0%		
Remark	D ≤ 0.1				

Note: Please multiply by $\sqrt{1+D^2}$ if D exceeds 0.1

Formula to convert capacitance to impedance: $Z_c = 1/2\pi fC$

Formula to convert inductance to impedance: $Z_L = 2\pi fL$

Please abide by the following instructions to ensure safe use of the meter:

1) Do not use the meter in an extreme environment, especially dusty environments, near high radiation, or around flammable substances.

- 2) Do not attempt to alter, repair, or calibrate the unit yourself. Such work should only be done by a trained professional or as directed by your distributor.
- 3) Do not attempt to modify the meter, break insulation, or remove working parts.
- 4) Be certain that all circuits have been shut down and are free of voltage.
- 5) Do not apply any input voltage to the meter. Be sure to discharge any electrified components such as capacitors.
- 6) This meter can be powered by two different methods. The first is by a 9V battery, and the second is by the included USB cable. USB will also allow the unit to sync data while it is being powered to save the life of the battery.

II. Ambient Conditions

- 1) Altitude: <2000 meters
- 2) Storage humidity: = 75% RH
- 3) Operating environment: 0°C ~ 40°C
- 4) Storage environment: -20°C ~ +50°C

III. Function Characteristics

- 1) Main display of 19,999 and auxiliary display of 1,999
- 2) Measurement frequency: 100Hz/120Hz/1KHz/10KHz/100KHz
- 3) Measurement voltage: 0.6Vrms
- 4) Output impedance: 120Ω
- 5) Basic precision: 0.5%
- 6) LCR automatic identification/manual measurement
- 7) Measurement of DCR DC resistance
- 8) Calibration compensation of open circuit/short-circuit
- 9) Automatic shutdown
- 10) Relative mode and tolerance sorting

11) Communication between Mini-USB and PC; Data acquisition/analysis/ statement

IV. Impedance Parameters

Impedance measurement instruments can be classified as DC impedance and AC impedance types. A general multimeter can be used to measure DC impedance, while a bridging instrument (such as this) can be used to measure AC or DC impedance. The 72-10465 is an intelligent double-display portable LCR digital electric bridge, with DC & AC impedance measurement functions. Impedance is one of the most fundamental parameters to analyze electronic elements and circuits. The resistance of linear diode is defined by Ohm's Law as part of a DC power scenario. Ratio of voltage and current is a complex impedance as part of an AC power scenario. One impedance vector includes one real part (resistance R) and one imaginary part (reactance X). Impedance is expressed by $R+jX$ in a rectangular coordinate, or expressed by the amplitude of real Z and phase angle of θ in a polar coordinate system. See figure 1-1 for relationship.

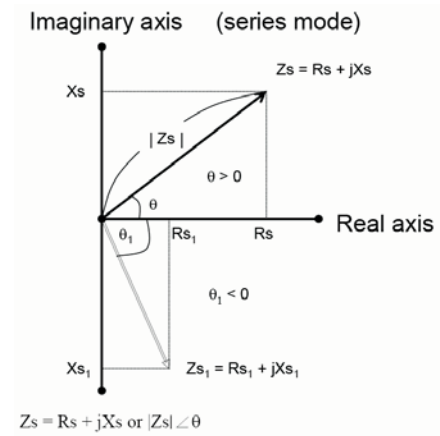

Figure 1-1

$$R_s = |Z_s| \cos \theta$$

$$X_s = |Z_s| \sin \theta$$

$$X_s/R_s = \tan \theta$$

$$\theta = \tan^{-1}(X_s/R_s)$$

Reaction is inductive if θ exceeds 0. In other words, reaction is capacitive if θ is less than 0.

V. Measurement Mode

Impedance can be used to measure serial or parallel mode. Impedance of Z under parallel link mode can be expressed by mutual access of Y. It can be defined as follows: $Y = G + jB$. G is conductance and B is admittance.

Impedance under serial link mode

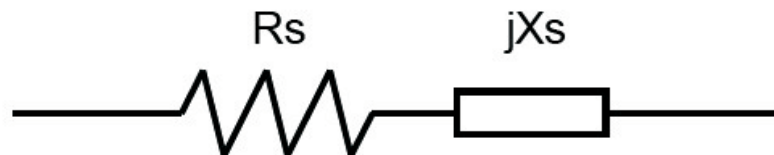

$$Z = R_s + jX_s$$

- Rs: Serial mode of resistance
- Xs: Serial mode of reaction
- Cs: Serial mode of capacitance
- Ls: Serial mode of inductance

Admittance parallel mode

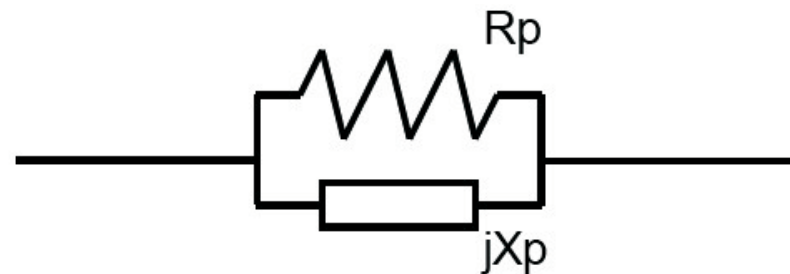

$$Y = 1/Z = 1/R_p + 1/jX_p = G + jB$$

- Rp: Parallel mode of resistance
- XP: Reaction under parallel mode
- CP: Parallel mode of capacitance
- LP: Parallel mode of inductance

VI. LCD Display Instructions (shown in Figure 2)

Main display instructions of LCD:

- (1) USB communication
- (2) Calibration of open circuit/short-circuit
- (3) Automatic shutdown
- (4) Relative measurement
- (5) Main display
- (6) Auxiliary display
- (7) Analog bar
- (8) Sieving tolerance mode
- (9) Data retention

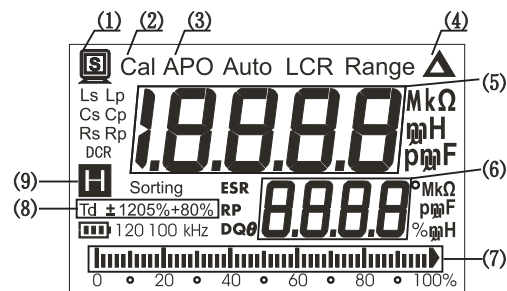

(shown in Figure 2)

Other definitions:

- 1) LCR: Automatic identification mode
- 2) Lp: Parallel measurement mode for inductance
- 3) Ls: Serial measurement mode for inductance
- 4) Cp: Parallel measurement mode for capacitance

- 5) Cs: Serial measurement mode for capacitance
- 6) Rp: Parallel measurement mode for resistance
- 7) Rs: Serial measurement mode for resistance
- 8) DCR: DC resistance measurement mode
- 9) D: Loss factor
- 10) Q: Quality factor
- 11) θ : Phase location angle
- 12) ESR: Equivalent serial resistance
- 13) EPR: Equivalent parallel resistance
- 14) DUT: Articles to measure
- 15) Key continuation can be expressed by pressing key for less than 1s or more than 2s.

VII. Instructions of key functions of 72-10465 front panel (shown in Figure 3)

- (1) LCD display zone
- (2) Frequency selection key/sieving function key
- (3) Calibration key of open circuit/short-circuit
- (4) Power key
- (5) USB communication function
- (6) Selection function of auxiliary parameter
- (7) Relative measurement function
- (8) Testing input terminal
- (9) Shielding protection terminal
- (10) Serial/parallel function
- (11) Selection for inductance, capacitance & resistance measurement

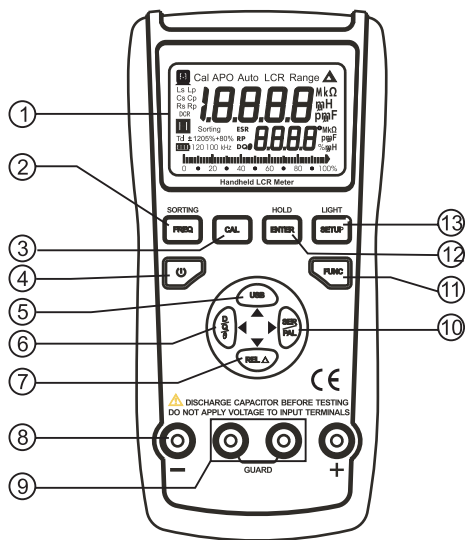

(shown in Figure 3)

- (12) Confirmation key/data retention
- (13) Sort settings

VIII. Operation Guideline

1. Automatic measurement

Default status is set to automatic identification mode (AUTO LCR) after powering on. Default frequency is 1K. Instrument will identify impedance characteristics of articles to measure automatically under automatic mode. It also will select main parameter, auxiliary parameter of L, C or R and suitable serial/parallel mode automatically.

Correspondence of main parameter and auxiliary parameter under automatic mode is as follows:

Capacitance C Loss Factor D
Inductance L Quality Factor Q

Resistance R Phase location angle θ

Serial/parallel mode can be determined according to impedance of articles to measure under automatic measurement mode. Parallel mode can be selected under higher impedance (of more than 10K Ω). Serial mode also can be selected

under lower impedance (of less than 10K Ω).

2. Data retention

Please press “HOLD” key for data retention during measurement. In the meanwhile, LCD can display data retention symbol of “”. Please press “HOLD” key again to exit data retention and return to normal measurement mode.

3. Measurement parameter under L/C/R mode

Please select corresponding parameters under manual L/C/R mode.

1) Selection of main parameter: Default status is AUTO LCR during power on.

Please select “FUNC” key to select parameters of “AUTO LCR→AUTO L→AUTO C→AUTO R→DCR→AUTO LCR” .

2) Selection of auxiliary parameter: Please press “SER/PAL” key under corresponding main parameter measurement mode for switchover of serial/parallel measurement mode. Please press “D/Q/ θ ” key to select auxiliary parameters of “D” , “Q” and “ESR” (Note: Please select serial measurement mode of “ESR” or parallel measurement mode of “RP”) Auxiliary parameter can be neglected quantitatively under “AUTO R” or “AUTO DCR” mode.

Note:

A. Please measure capacitance under “AUTO LCR” mode. Please substitute loss factor of auxiliary parameter of D by equivalent parallel resistance of Rp if capacitance is less than 5pF.

B. Some parameters of auxiliary parameter will not be displayed on LCD when entering into “AUTO R” or “AUTO DCR” for measurement under “AUTO LCR” mode.

4. Measurement frequency

“1KHz→10KHz→100KHz→100Hz→120Hz→1KHz” 。

72-10465 can provide 5 frequency testing points, namely, 100Hz/120Hz/1KHz/10KHz/100K Hz. Bootstrap default frequency is 1K and user can press “FREQ” key to select different frequency points for measurement of “1KHz→10KHz→100KHz→100Hz→120Hz→1KHz” .

Note: DC impedance is measured under “AUTO DCR” mode and measurement frequency also can be neglected.

5. Measurement of deviation proportion

Deviation measurement is used to compare with deviation ratio of 2 elements.

Main display is main value of measured elements. Auxiliary display is deviation percentage. Main LCD display can be typed in automatically as nominal value.

Percentage display scope: -99.9%~99.9%

Display percentage: $REL\% = (D_{CUR} - D_{REF}) / D_{REF} * 100\%$

DCUR : Main parameter of measured elements

DREF : Typed nominal value

Auxiliary display is “OL%” and main display is main parameter of measured elements if $D_{CUR} > 2D_{REF}$ or $2D_{CUR} < D_{REF}$.

1) Entry into deviation measurement

User can press “FUNC” key to select suitable modes of “AUTO L” , “AUTO C” , “AUTO R” or “AUTO DCR” . Please confirm that testing terminal has been connected to measured element and press “REL” key to enter into deviation proportion measurement mode. LCD will display “▲” symbol. Main display is main parameter of measured elements and auxiliary display is display percentage deviation by way of percentage. User also can press “REL” key for main display of nominal value. “▲” symbol on LCD will flicker and display. Percentage deviation also can display for auxiliary display by way of percentage. User also can press “REL” key to return to normal deviation measurement mode again.

2) Exit of deviation measurement

User can press “REL” key for a long time to exit deviation measurement and return to normal mode.

6. Sorting Measurement

Sorting measurement mode is used to sort elements of which main parameter is within a certain scope quickly. User can press “FUNC” key to select suitable modes of “AUTO L” , “AUTO C” , “AUTO R” or “AUTO DCR” .Please confirm that testing terminal has been connected to measured element and press “FREQ” for a long time to enter into sieving mode. LCD will display “Sorting” symbol. Main display is “PASS” and auxiliary display is main value of measured elements with typed nominal value and buzzer rings. Main display is “FALL” and auxiliary display is main value of measured elements if exceeding extreme scope.

1) Setting sorting range

The sorting function range can be set to $\pm 0.25\%$, $\pm 0.5\%$, $\pm 1\%$, $\pm 2\%$, $\pm 5\%$, $\pm 10\%$, $\pm 20\%$ and $+80\% \sim -20\%$. Default range $\pm 1\%$. User can press “SETUP” key for setup under sorting measurement mode. “Range” symbol on LCD flickers and displays. User can press “ENTER” to confirm entry into setting page of main parameter. Final character of main parameter on LCD flickers. User can press

value of “▼” key to decrease value one by one. He also can press “▲” to increase value one by one. He can press main parameter of “▶” key for rightward movement of cursor position. He can press “◀” key for leftward movement of cursor position. of main parameter with corresponding value adjustment. He can press “ENTUP” key to enter into sieving scope for setting and flickering of “TOL” $\pm 1\%$ symbol on LCD. He can press “▶” or “◀” key to adjust value within sieving scope. He also can press “ENTER” to confirm setting of sorting & measurement of elements.

2) Exit of sorting mode

User can press “Sorting” key to exit sieving & measurement mode and return to normal mode.

7. Calibration function

Calibration function can be used to reduce interference of distribution parameters brought in by testing wires effectively. Calibration function includes short-circuit calibration and open circuit calibration. Short-circuit calibration can be adopted to reduce influence of contact resistance and testing wire resistance to measure low-impedance elements. Open circuit calibration also can be adopted to reduce

influence of distributed capacitance and distributed resistance of testing wires to measure high-impedance elements.

1) Entry into calibration function (with inserting images)

User can press “CAL” key for a long time to enter into open circuit for calibration. (As shown in Figure 4,) auxiliary display on LCD can show “OPEN”. User also can press “CAL” to begin calibration. (As shown in Figure 5), LCD also will show “PASS” after countdown from 30s to 0.



Figure 4



Figure 5

It refers to finishing calibration of open circuit. User can press “CAL” key to show “*Srt*” (shown in Figure 6) on auxiliary display of LCD. User can insert short-circuit pieces into testing terminal and then press “CAL” key to begin calibration. (As shown in Figure 7), LCD will show “*PASS*” after countdown from 30s to 0 to show finishing short-circuit calibration. User also can press “CAL” key to return to normal measurement mode.

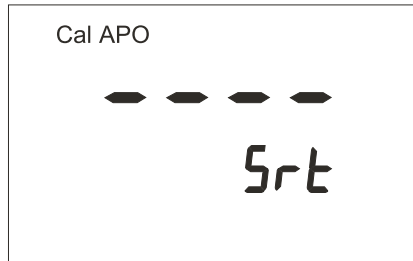

Figure 6



Figure 7

Note: (As shown in Figure 8,) LCD will show “*FAIL*” for open circuit calibration.



Figure 8

It refers to calibration failure. Please check if testing terminal is under open circuit status or not to guarantee re-calibration of open circuit. (As shown in Figure 9), LCD will show “*FAIL*” for short-circuit calibration.



Figure 9

It refers to calibration failure. Check if testing terminals have been inserted into short-circuit pieces or not to guarantee normal short-circuit re-calibration.

8. PC communication

Press “PC” key to enter into communication function for “” display on LCD. Insert USB wire and start software of PC end upper host for data transmission. Press “PC” key to exit communication function and interrupt data transmission.

9. Press and hold the "LIGHT" key to activate the LCD backlight. The backlight will automatically shut off after 60 seconds.

10. Auto power off

Power off after about 5 minutes of idling

IX. Fast Application Guideline

1. Selection of serial/parallel mode

Suitable equivalent mode can be selected to gain more precise measurement data. In general, it is suggested to select serial equivalent mode for low-impedance element (such as less than 100Ω). It is suggested to select parallel equivalent mode for high-impedance element (such as more than 10 kΩ). Serial/parallel equivalent mode also has little influence for measurement result.

2. Inductance measurement

- 1) Press “” for power on.
- 2) Press “FUNC” to display “Lp” on LCD and select inductance measurement gear.
- 3) Insert inductance into testing port or connect corresponding fittings to measured inductance (shown in Figure 10).
- 4) To press “FREQ” key to select suitable testing frequency.
- 5) Press “D/Q/θ” to select auxiliary parameter to measure.

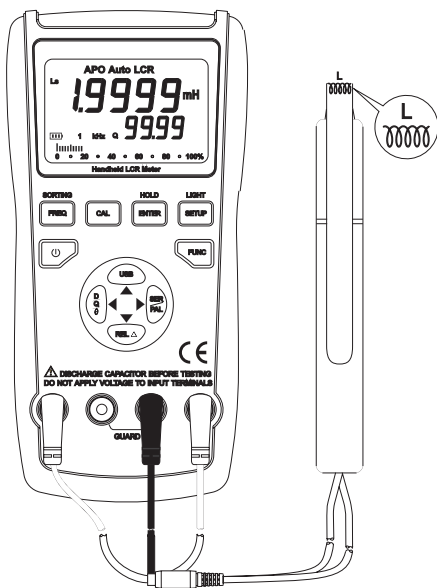

Figure 10

3. Capacitors must be discharged completely before measurement.
- 1) Press “ ⏻ ” for power on.
- 2) Press “FUNC” to display “Cp” on LCD and select capacitance measurement gear.
- 3) Insert capacitance into testing port or connect corresponding fittings to measured capacitance (shown in Figure 11).
- 4) To press “FREQ” key to select suitable testing frequency.
- 5) Press “D/Q/θ” to select auxiliary parameter to measure.

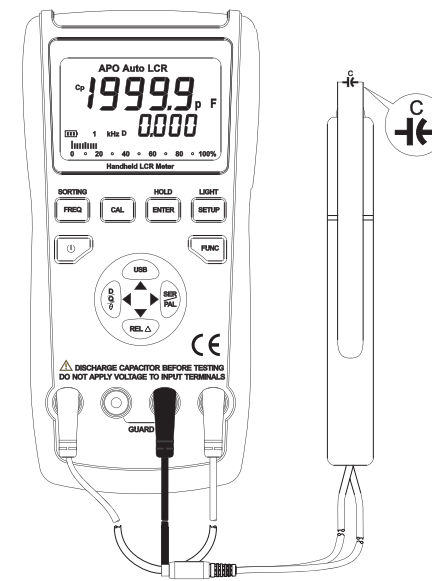

Figure 11

4. Resistance measurement
 - 1) Press “ ⏻ ” for power on.
 - 2) Press “FUNC” to display “Rp” on LCD and select capacitance measurement gear.
 - 3) Insert resistance into testing port or connect corresponding fittings to measured capacitance (shown in Figure 12).
 - 4) To press “FREQ” key to select suitable testing frequency.

Note: Auxiliary parameter of resistance measurement will be neglected and auxiliary parameter will not be displayed on LCD.

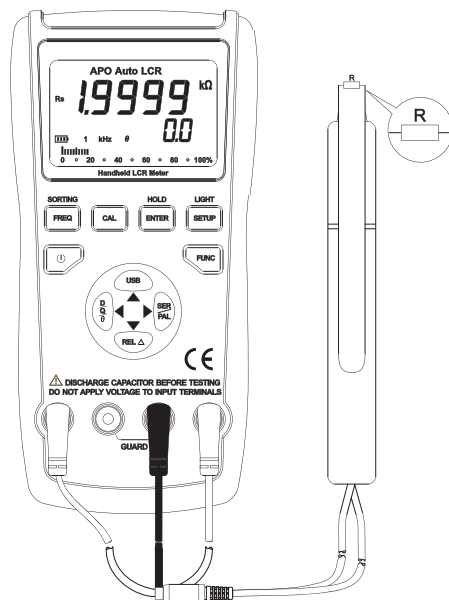

Figure 12

5. Measurement of DC impedance
 - 1) Press “ ⏻ ” for power on.
 - 2) Press “FUNC” to display “DCR” on LCD and select measurement gear of DC resistance.
 - 3) Insert resistance into testing port or connect corresponding fittings to measured resistance (shown in Figure 13).

Note: Auxiliary parameter and measurement frequency of DC resistance will be neglected and auxiliary parameter will not be displayed on LCD.

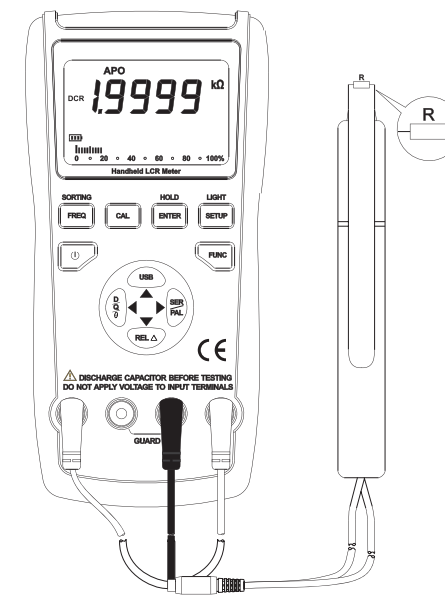

Figure 13

X. PC Communication Protocol

Start PC communication function to connect instrument and computer by USB wire for data acquisition.

Communication parameters:

- 1) Bit rate: 9600
 - 2) Data bit: 8
 - 3) Start bit: 1
 - 4) Stop bit: 1
 - 5) Inspection: Without
- Connection mode is shown in the figure:



XI. Technical Indicators

Note:

- 1) Testing ambient temperature: $23^{\circ}\text{C} \pm 5^{\circ}\text{C}$; Humidity: =75% R.H
- 2) Pre-heat for 10 minutes before test;
- 3) Test on port slot of instruments;
- 4) Calibrate open circuit/short-circuit before test;
- 5) The actual measurement and displaying scope of the device go beyond the specified scope in the table; but no accuracy is specified for the measuring value

which goes beyond the scope in the table

Function	Measurement mode	Frequency	Range	The minimum resolution	Precision \pm (a% of reading + b of word quantity) (under 18°C to 28°C)	
L Inductance gear	Rs/Rp	100Hz/120Hz	20.000mH	1uH	1.0%+5	
			200.00mH	0.01mH	0.5%+5	
			2000.0mH	0.1mH	0.5%+5	
			20.000H	1mH	0.5%+5	
			200.00H	0.01H	1.0%+5	
			2000.0H	0.1H	1.0%+5	
		1KHz	20.000kH	0.001kH	2.0%+5	
			2000.0uH	0.1uH	1.0%+5	
			20.000mH	1uH	0.5%+5	
			200.00mH	0.01mH	0.5%+5	
			2000.0mH	0.1mH	1.0%+5	
			20.000H	1mH	1.0%+5	
		10KHz	200.00uH	0.01uH	1.0%+5	
			2000.0uH	0.1uH	0.5%+5	
			20.000mH	1uH	0.5%+5	
			200.0mH	0.01mH	1.5%+5	
			2000.0mH	0.1mH	2.0%+5	
			20.000H	1mH	5.0%+5	
		100KHz	20.00uH	0.001uH	1.0%+5	
			200.00uH	0.01uH	2.0%+5	
			2000.0uH	0.01uH	2.0%+5	
			20.000mH	1uH	2.0%+5	
				200.00mH	0.01mH	5.0%+5

Note: The precision is evaluated if D is less than 0.1. $Ae = Ae * \sqrt{1 + D^2}$ if D exceeds 0.1. (Ae: Precision)

Function	Measurement mode	Frequency	Range	The minimum resolution	Precision ± (a% of reading + b of word quantity) (under 18°C to 28°C)
CAP Capacitance gear	Cs/Op	100Hz/120Hz	20.000nF	1pF	2.0%+5
			200.00nF	0.01nF	0.5%+5
			2000.0nF	0.1nF	0.5%+5
			20.000uF	1nF	0.5%+5
			200.00uF	0.01uF	1.0%+5
			2000.0uF	0.1uF	2.0%+5
		20.00mF	0.01mF	2.0%+5	
		1KHz	2000.0pF	0.01pF	1.0%+5
			20.000nF	0.1pF	1.0%+5
			200.00nF	0.01nF	0.5%+5
			2000.0nF	0.1nF	0.5%+5
			20.000uF	1nF	0.5%+5
			200.00uF	0.01uF	1.0%+5
		2000uF	1uF	2.0%+5	
		10KHz	200.00pF	0.01pF	2.0%+5
			2000.0pF	0.1pF	1.0%+5
			20.000nF	1pF	1.0%+5
			200.00nF	0.01nF	1.5%+5
		2000.0nF	0.1nF	2.0%+5	
			200.00pF	0.01pF	2.0%+5
			2000.0pF	0.1pF	2.0%+5
			20.000nF	1pF	2.0%+5
		200.00nF	0.01nF	5.0%+5	

Note: The precision is evaluated if D is less than 0.1. $Ae = Ae * \sqrt{1 + D^2}$ if D exceeds 0.1. (Ae: Precision)

Function	Measurement mode	Frequency	Range	The minimum resolution	Precision ± (a% of reading + b of word quantity) (under 18°C to 28°C)	
R Resistance gear	Rs/Rp	100Hz/120Hz	200.00Ω	0.01Ω	1.0%+5	
			2.0000kΩ	0.1Ω	0.3%+5	
			20.000kΩ	1Ω	0.3%+5	
			200.00kΩ	0.01kΩ	0.5%+5	
			2.0000MΩ	0.1kΩ	1.0%+5	
			20.000MΩ	1kΩ	2.0%+5	
		20.00MΩ	0.1MΩ	2.0%+5		
		1KHz	20.000Ω	1mΩ	1.0%+5	
			200.00Ω	0.01Ω	1.0%+5	
			2.0000kΩ	0.1Ω	0.3%+5	
			20.000kΩ	1Ω	0.3%+5	
			200.00kΩ	0.01kΩ	0.5%+5	
			2.0000MΩ	0.1kΩ	1.0%+5	
		20.000MΩ	1kΩ	2.0%+5		
		20.00MΩ	0.1MΩ	5.0%+5		
		10KHz	20.000Ω	1mΩ	1.0%+5	
			200.00Ω	0.01Ω	1.0%+5	
			2.0000kΩ	0.1Ω	0.3%+5	
			20.000kΩ	1Ω	0.5%+5	
		200.00kΩ	0.01kΩ	1.0%+5		
		100KHz	20.000Ω	1mΩ	2.0%+5	
			200.00Ω	0.01Ω	2.0%+5	
			2.0000kΩ	0.1Ω	1.0%+5	
			20.000kΩ	1Ω	2.0%+5	
		DCR		200.00Ω	0.01Ω	1%+5

R Resistance gear	DCR	2.0000k Ω	0.1 Ω	0.3% + 5
		20.000k Ω	1 Ω	0.3% + 5
		200.00k Ω	0.01k Ω	0.5% +5
		2.0000M Ω	0.1k Ω	1% +5
		20.000M Ω	1k Ω	2% +5
		200.00M Ω	0.1M Ω	2% +5

Note: The precision is evaluated if D is less than 0.1. $Ae = Ae * \sqrt{1 - D^2}$ If D exceeds 0.1. (Ae: Precision)

XII. Battery Replacement

⚠ Warning

Please replace the battery immediately when the " - " prompt is displayed to avoid errors in measurement.

Please replace the old battery with a new alkaline 9V battery.

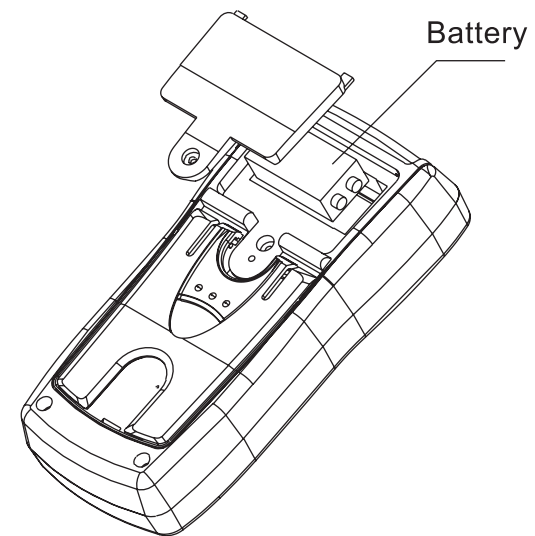

XIII. Maintenance

1) Cleaning

Please power off and remove battery and external power before cleaning. Please use a damp, soft cloth to wipe away any dirt and debris; do not allow water to drip inside of the case. The meter can not be used until the case is clean and dry.

2) Moisture prevention

Please use instruments in dry environment and store them in dry locations after use. Please power off the unit immediately and remove battery if water begins to penetrate the casing. Do not detach the casing from the meter. Please contact your dealer or distributor for repair.

3) Repair

Please inspect the battery or external power first if there is power on failure. Please check if “⏻” key is invalid or not.

Please check if testing wires are excellent with excellent contact between clip in testing port and element foot or not for abnormal measurement result. Please confirm correct operation and use. It is not allowed to detach shell or replace element & circuit individually. Please contact related dealers or after-sales service agents of our company for repair confirmation failure.

Copyright 2012 Tenma Test Equipment.
All rights reserved.

Distributed by:
MCM Electronics
405 S. Pioneer Blvd.
Springboro, OH 45066
800-543-4330
www.tenma.com