



Is Now Part of



**ON Semiconductor®**

To learn more about ON Semiconductor, please visit our website at  
[www.onsemi.com](http://www.onsemi.com)

ON Semiconductor and the ON Semiconductor logo are trademarks of Semiconductor Components Industries, LLC dba ON Semiconductor or its subsidiaries in the United States and/or other countries. ON Semiconductor owns the rights to a number of patents, trademarks, copyrights, trade secrets, and other intellectual property. A listing of ON Semiconductor's product/patent coverage may be accessed at [www.onsemi.com/site/pdf/Patent-Marking.pdf](http://www.onsemi.com/site/pdf/Patent-Marking.pdf). ON Semiconductor reserves the right to make changes without further notice to any products herein. ON Semiconductor makes no warranty, representation or guarantee regarding the suitability of its products for any particular purpose, nor does ON Semiconductor assume any liability arising out of the application or use of any product or circuit, and specifically disclaims any and all liability, including without limitation special, consequential or incidental damages. Buyer is responsible for its products and applications using ON Semiconductor products, including compliance with all laws, regulations and safety requirements or standards, regardless of any support or applications information provided by ON Semiconductor. "Typical" parameters which may be provided in ON Semiconductor data sheets and/or specifications can and do vary in different applications and actual performance may vary over time. All operating parameters, including "Typicals" must be validated for each customer application by customer's technical experts. ON Semiconductor does not convey any license under its patent rights nor the rights of others. ON Semiconductor products are not designed, intended, or authorized for use as a critical component in life support systems or any FDA Class 3 medical devices or medical devices with a same or similar classification in a foreign jurisdiction or any devices intended for implantation in the human body. Should Buyer purchase or use ON Semiconductor products for any such unintended or unauthorized application, Buyer shall indemnify and hold ON Semiconductor and its officers, employees, subsidiaries, affiliates, and distributors harmless against all claims, costs, damages, and expenses, and reasonable attorney fees arising out of, directly or indirectly, any claim of personal injury or death associated with such unintended or unauthorized use, even if such claim alleges that ON Semiconductor was negligent regarding the design or manufacture of the part. ON Semiconductor is an Equal Opportunity/Affirmative Action Employer. This literature is subject to all applicable copyright laws and is not for resale in any manner.

## 74VHC541 Octal Buffer/Line Driver with 3-STATE Outputs

### General Description

The VHC541 is an advanced high-speed CMOS device fabricated with silicon gate CMOS technology. It achieves the high-speed operation similar to equivalent Bipolar Schottky TTL while maintaining the CMOS low power dissipation.

The VHC541 is an octal buffer/line driver designed to be employed as memory and address drivers, clock drivers and bus oriented transmitter/receivers.

This device is similar in function to the VHC244 while providing flow-through architecture (inputs on opposite side from outputs). This pinout arrangement makes this device especially useful as an output port for microprocessors, allowing ease of layout and greater PC board density.

An input protection circuit insures that 0V to 7V can be applied to the input pins without regard to the supply voltage. This device can be used to interface 5V to 3V systems and two supply systems such as battery backup. This circuit prevents device destruction due to mismatched supply and input voltages.

### Features

- High Speed:  $t_{PD} = 3.5 \text{ ns}$  (typ) at  $V_{CC} = 5V$
- Low power dissipation:  $I_{CC} = 4 \mu\text{A}$  (max) at  $T_A = 25^\circ\text{C}$
- High noise immunity:  $V_{NIH} = V_{NIL} = 28\% V_{CC}$  (min)
- Power down protection is provided on all inputs
- Low noise:  $V_{OLP} = 0.9V$  (typ)
- Pin and function compatible with 74HC541

### Ordering Code:

| Order Number | Package Number | Package Description   |
|--------------|----------------|---|
| 74VHC541M    | M20B           | 20-Lead Small Outline Integrated Circuit (SOIC), JEDEC MS-013, 0.300" Wide  |
| 74VHC541SJ   | M20D           | Pb-Free 20-Lead Small Outline Package (SOP), EIAJ TYPE II, 5.3mm Wide       |
| 74VHC541MTC  | MTC20          | 20-Lead Thin Shrink Small Outline Package (TSSOP), JEDEC MO-153, 4.4mm Wide |
| 74VHC541N    | N20A           | 20-Lead Plastic Dual-In-Line Package (PDIP), JEDEC MS-001, 0.300" Wide      |

Surface mount packages are also available on Tape and Reel. Specify by appending the suffix letter "X" to the ordering code.  
Pb-Free package per JEDEC J-STD-020B.

### Connection Diagram

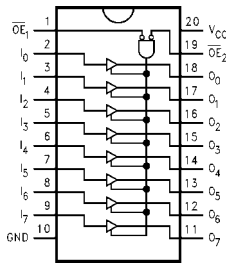

### Logic Symbol

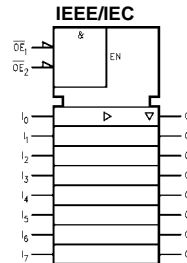

### Pin Descriptions

| Pin Names                          | Descriptions                 |
|------------------------------------|------------------------------|
| $\overline{OE}_1, \overline{OE}_2$ | 3-STATE Output Enable Inputs |
| $I_0 - I_7$                        | Inputs                       |
| $O_0 - O_7$                        | 3-STATE Outputs              |

### Truth Table

| Inputs            |                   |   | Outputs |
|-------------------|-------------------|---|---------|
| $\overline{OE}_1$ | $\overline{OE}_2$ | I |         |
| L                 | L                 | H | H       |
| H                 | X                 | X | Z       |
| X                 | H                 | X | Z       |
| L                 | L                 | L | L       |

H = HIGH Voltage Level  
L = LOW Voltage Level  
X = Immaterial  
Z = High Impedance

**Absolute Maximum Ratings** (Note 1)

|   |                          |
|---|--------------------------|
| Supply Voltage ( $V_{CC}$ )                           | -0.5V to +7.0V           |
| DC Input Voltage ( $V_{IN}$ )                         | -0.5V to +7.0V           |
| DC Output Voltage ( $V_{OUT}$ )                       | -0.5V to $V_{CC} + 0.5V$ |
| Input Diode Current ( $I_{IK}$ )                      | -20 mA                   |
| Output Diode Current ( $I_{OK}$ )                     | $\pm 20$ mA              |
| DC Output Current ( $I_{OUT}$ )                       | $\pm 25$ mA              |
| DC $V_{CC}/GND$ Current ( $I_{CC}$ )                  | $\pm 75$ mA              |
| Storage Temperature ( $T_{STG}$ )                     | -65°C to +150°C          |
| Lead Temperature ( $T_L$ )<br>(Soldering, 10 seconds) | 260°C                    |

**Recommended Operating Conditions** (Note 2)

|   |                |
|---|----------------|
| Supply Voltage ( $V_{CC}$ )             | 2.0V to +5.5V  |
| Input Voltage ( $V_{IN}$ )              | 0V to +5.5V    |
| Output Voltage ( $V_{OUT}$ )            | 0V to $V_{CC}$ |
| Operating Temperature ( $T_{OPR}$ )     | -40°C to +85°C |
| Input Rise and Fall Time ( $t_r, t_f$ ) |                |
| $V_{CC} = 3.3V \pm 0.3V$                | 0 ~ 100 ns/V   |
| $V_{CC} = 5.0V \pm 0.5V$                | 0 ~ 20 ns/V    |

**Note 1:** Absolute Maximum Ratings are values beyond which the device may be damaged or have its useful life impaired. The databook specifications should be met, without exception, to ensure that the system design is reliable over its power supply, temperature, and output/input loading variables. Fairchild does not recommend operation outside databook specifications.

**Note 2:** Unused inputs must be held HIGH or LOW. They may not float

**DC Electrical Characteristics**

| Symbol   | Parameter                        | $V_{CC}$<br>(V)  | $T_A = 25^\circ\text{C}$ |      |                      | $T_A = -40^\circ\text{C to } +85^\circ\text{C}$ |      | Units         | Conditions   |  |
|----------|----------------------------------|------------------|--------------------------|------|----------------------|---|------|---------------|--|--|
|          |                                  |                  | Min                      | Typ  | Max                  | Min   | Max  |               |  |  |
| $V_{IH}$ | HIGH Level Input Voltage         | 2.0<br>3.0 - 5.5 | 1.50<br>0.7 $V_{CC}$     |      |                      | 1.50<br>0.7 $V_{CC}$                            |      | V             |  |  |
| $V_{IL}$ | LOW Level Input Voltage          | 2.0<br>3.0 - 5.5 |                          |      | 0.50<br>0.3 $V_{CC}$ | 0.50<br>0.3 $V_{CC}$                            |      | V             |  |  |
| $V_{OH}$ | HIGH Level Output Voltage        | 2.0              | 1.9                      | 2.0  |                      | 1.9   |      | V             | $V_{IN} = V_{IH}$<br>or $V_{IL}$                           | $I_{OH} = -50 \mu\text{A}$                           |
|          |                                  | 3.0              | 2.9                      | 3.0  |                      | 2.9   |      |               |  |  |
|          |                                  | 4.5              | 4.4                      | 4.5  |                      | 4.4   |      | V             |  | $I_{OH} = -4 \text{ mA}$<br>$I_{OH} = -8 \text{ mA}$ |
|          |                                  | 3.0              | 2.58                     |      |                      | 2.48  |      |               |  |  |
| 4.5      | 3.94                             |                  |                          | 3.80 |                      |   |      |               |  |  |
| $V_{OL}$ | LOW Level Output Voltage         | 2.0              |                          | 0.0  | 0.1                  |   | 0.1  | V             | $V_{IN} = V_{IH}$<br>or $V_{IL}$                           | $I_{OL} = 50 \mu\text{A}$                            |
|          |                                  | 3.0              |                          | 0.0  | 0.1                  |   | 0.1  |               |  |  |
|          |                                  | 4.5              |                          | 0.0  | 0.1                  |   | 0.1  | V             |  | $I_{OL} = 4 \text{ mA}$<br>$I_{OL} = 8 \text{ mA}$   |
|          |                                  | 3.0              |                          |      | 0.36                 |   | 0.44 |               |  |  |
| 4.5      |                                  |                  | 0.36                     |      | 0.44                 |   |      |               |  |  |
| $I_{OZ}$ | 3-STATE Output Off-State Current | 5.5              |                          |      | $\pm 0.25$           | $\pm 2.5$                                       |      | $\mu\text{A}$ | $V_{IN} = V_{IH}$ or $V_{IL}$<br>$V_{OUT} = V_{CC}$ or GND |  |
| $I_{IN}$ | Input Leakage Current            | 0 - 5.5          |                          |      | $\pm 0.1$            | $\pm 1.0$                                       |      | $\mu\text{A}$ | $V_{IN} = 5.5V$ or GND                                     |  |
| $I_{CC}$ | Quiescent Supply Current         | 5.5              |                          |      | 4.0                  | 40.0  |      | $\mu\text{A}$ | $V_{IN} = V_{CC}$ or GND                                   |  |

**Noise Characteristics**

| Symbol                | Parameter                                | $V_{CC}$<br>(V) | $T_A = 25^\circ\text{C}$ |        | Units | Conditions            |
|-----------------------|--|-----------------|--------------------------|--------|-------|-----------------------|
|                       |  |                 | Typ                      | Limits |       |                       |
| $V_{OLP}$<br>(Note 3) | Quiet Output Maximum Dynamic $V_{OL}$    | 5.0             | 0.9                      | 1.2    | V     | $C_L = 50 \text{ pF}$ |
| $V_{OLV}$<br>(Note 3) | Quiet Output Minimum Dynamic $V_{OL}$    | 5.0             | -0.8                     | -1.0   | V     | $C_L = 50 \text{ pF}$ |
| $V_{IHD}$<br>(Note 3) | Minimum HIGH Level Dynamic Input Voltage | 5.0             |                          | 3.5    | V     | $C_L = 50 \text{ pF}$ |
| $V_{ILD}$<br>(Note 3) | Maximum HIGH Level Dynamic Input Voltage | 5.0             |                          | 1.5    | V     | $C_L = 50 \text{ pF}$ |

**Note 3:** Parameter guaranteed by design.

| AC Electrical Characteristics |                                   |                        |                       |      |     |                                 |     |   |            |
|-------------------------------|-----------------------------------|------------------------|-----------------------|------|-----|---------------------------------|-----|---|------------|
| Symbol                        | Parameter                         | V <sub>CC</sub><br>(V) | T <sub>A</sub> = 25°C |      |     | T <sub>A</sub> = -40°C to +85°C |     | Units   | Conditions |
|                               |                                   |                        | Min                   | Typ  | Max | Min                             | Max |   |            |
| t <sub>PLH</sub>              | Propagation Delay<br>Time         | 3.3 ± 0.3              | 5.0                   | 7.0  | 1.0 | 8.5                             | ns  | C <sub>L</sub> = 15 pF                          |            |
| t <sub>PHL</sub>              |                                   |                        | 7.5                   | 10.5 | 1.0 | 12.0                            |     | C <sub>L</sub> = 50 pF                          |            |
|                               |                                   | 5.0 ± 0.5              | 3.5                   | 5.0  | 1.0 | 6.0                             | ns  | C <sub>L</sub> = 15 pF                          |            |
|                               |                                   |                        | 5.0                   | 7.0  | 1.0 | 8.0                             |     | C <sub>L</sub> = 50 pF                          |            |
| t <sub>PZL</sub>              | 3-STATE Output<br>Enable Time     | 3.3 ± 0.3              | 6.8                   | 10.5 | 1.0 | 12.5                            | ns  | R <sub>L</sub> = 1 kΩ<br>C <sub>L</sub> = 15 pF |            |
| t <sub>PZH</sub>              |                                   |                        | 9.3                   | 14.0 | 1.0 | 16.0                            |     | C <sub>L</sub> = 50 pF                          |            |
|                               |                                   | 5.0 ± 0.5              | 4.7                   | 7.2  | 1.0 | 8.5                             | ns  | C <sub>L</sub> = 15 pF                          |            |
|                               |                                   |                        | 6.2                   | 9.2  | 1.0 | 10.5                            |     | C <sub>L</sub> = 50 pF                          |            |
| t <sub>PLZ</sub>              | 3-STATE<br>Output<br>Disable Time | 3.3 ± 0.3              | 11.2                  | 15.4 | 1.0 | 17.5                            | ns  | R <sub>L</sub> = 1 kΩ<br>C <sub>L</sub> = 50 pF |            |
| t <sub>PHZ</sub>              |                                   | 5.0 ± 0.5              | 6.0                   | 8.8  | 1.0 | 10.0                            |     | C <sub>L</sub> = 50 pF                          |            |
| t <sub>OSSLH</sub>            | Output to Output Skew             | 3.3 ± 0.3              |                       | 1.5  |     | 1.5                             | ns  | (Note 4)<br>C <sub>L</sub> = 50 pF              |            |
| t <sub>OSSLH</sub>            |                                   | 5.0 ± 0.5              |                       | 1.0  |     | 1.0                             |     | C <sub>L</sub> = 50 pF                          |            |
| C <sub>IN</sub>               | Input Capacitance                 |                        | 4                     | 10   |     | 10                              | pF  | V <sub>CC</sub> = Open                          |            |
| C <sub>OUT</sub>              | Output Capacitance                |                        | 6                     |      |     |                                 | pF  | V <sub>CC</sub> = 5.0V                          |            |
| C <sub>PD</sub>               | Power Dissipation Capacitance     |                        | 18                    |      |     |                                 | pF  | (Note 5)  |            |

**Note 4:** Parameter guaranteed by design.  $t_{OSSLH} = |t_{PLHmax} - t_{PLHmin}|$ ;  $t_{OSSLH} = |t_{PHLmax} - t_{PHLmin}|$ .

**Note 5:** C<sub>PD</sub> is defined as the value of the internal equivalent capacitance which is calculated from the operating current consumption without load. Average operating current can be obtained by the equation:  $I_{CC(OPR.)} = C_{PD} * V_{CC} * f_{IN} + I_{CC}/8$  (per bit).

**Physical Dimensions** inches (millimeters) unless otherwise noted

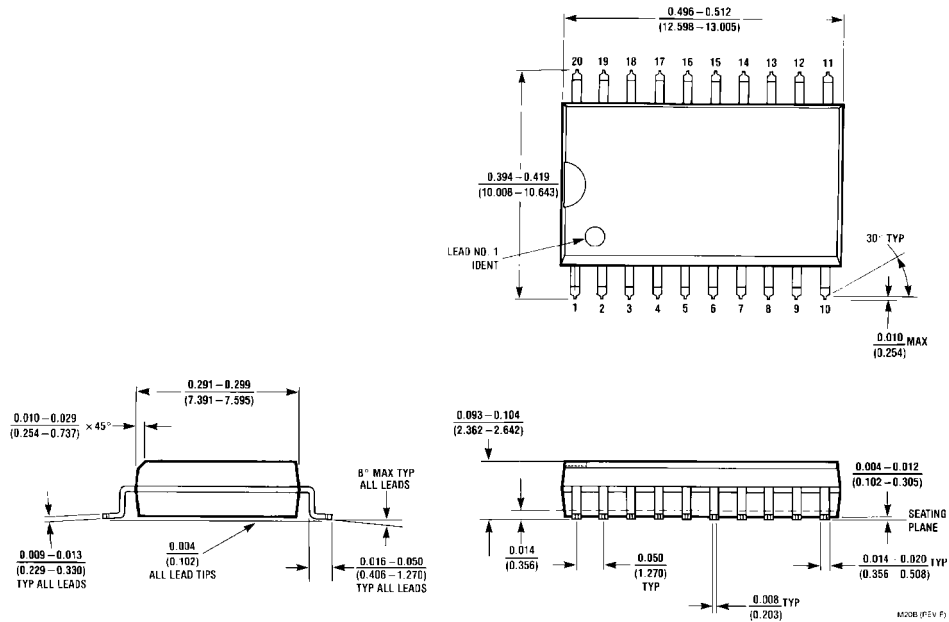

**20-Lead Small Outline Integrated Circuit (SOIC), JEDEC MS-013, 0.300" Wide  
Package Number M20B**

**Physical Dimensions** inches (millimeters) unless otherwise noted (Continued)

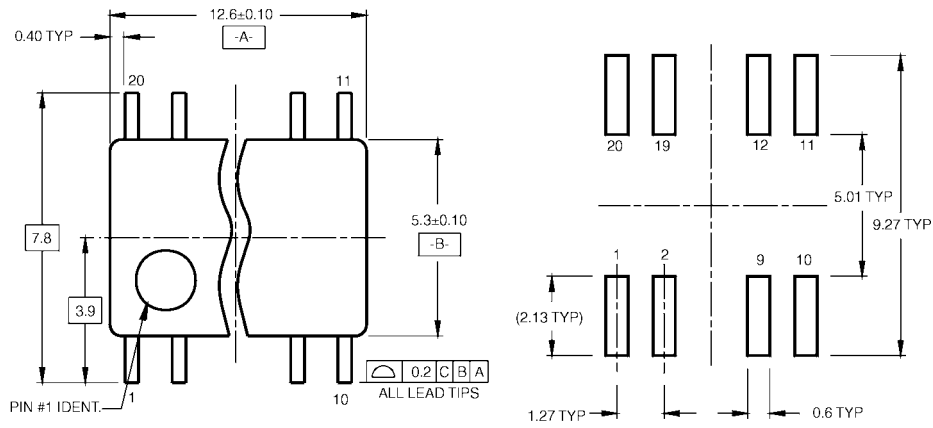

LAND PATTERN RECOMMENDATION

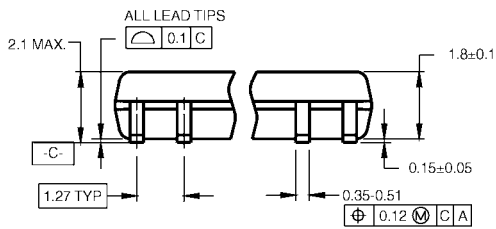

DIMENSIONS ARE IN MILLIMETERS

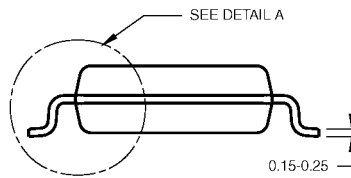

- NOTES:
- A. CONFORMS TO EIAJ EDR-7320 REGISTRATION, ESTABLISHED IN DECEMBER, 1998.
  - B. DIMENSIONS ARE IN MILLIMETERS.
  - C. DIMENSIONS ARE EXCLUSIVE OF BURRS, MOLD FLASH, AND TIE BAR EXTRUSIONS.

M20DRevB1

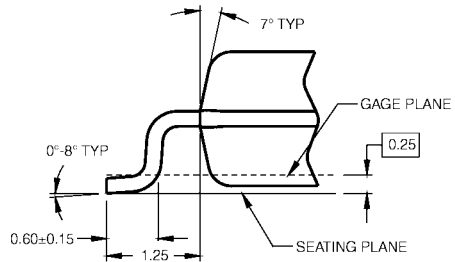

DETAIL A

**Pb-Free 20-Lead Small Outline Package (SOP), EIAJ TYPE II, 5.3mm Wide  
Package Number M20D**

**Physical Dimensions** inches (millimeters) unless otherwise noted (Continued)

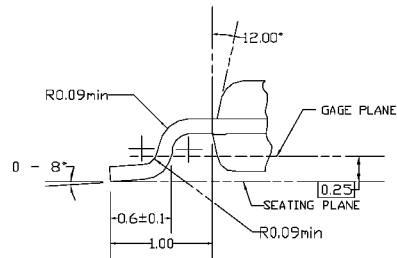
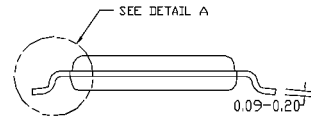
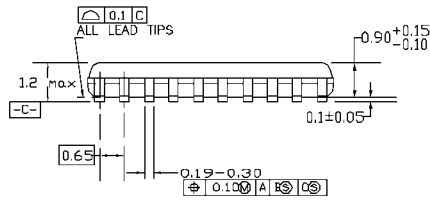
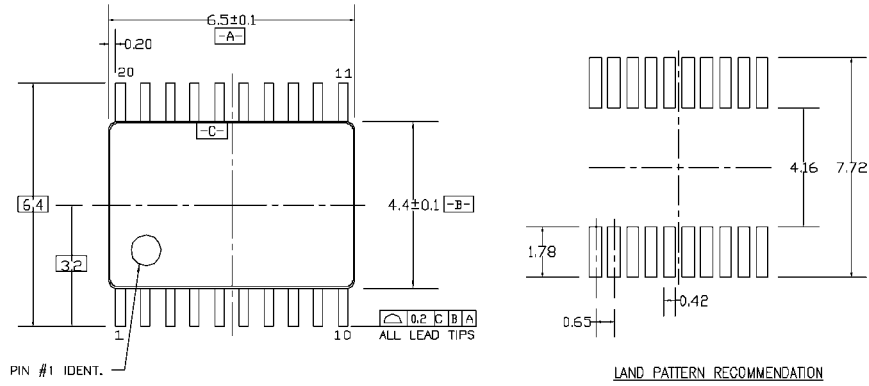

DIMENSIONS ARE IN MILLIMETERS

NOTES:

- A. CONFORMS TO JEDEC REGISTRATION MO-153, VARIATION AC, REF NOTE 6, DATE 7/93.
- B. DIMENSIONS ARE IN MILLIMETERS.
- C. DIMENSIONS ARE EXCLUSIVE OF BURRS, MOLDS FLASH, AND TIE BAR EXTRUSIONS.
- D. DIMENSIONS AND TOLERANCES PER ANSI Y14.5M, 1982.

MTC20REV D1

**20-Lead Thin Shrink Small Outline Package (TSSOP), JEDEC MO-153, 4.4mm Wide Package Number MTC20**

**Physical Dimensions** inches (millimeters) unless otherwise noted (Continued)

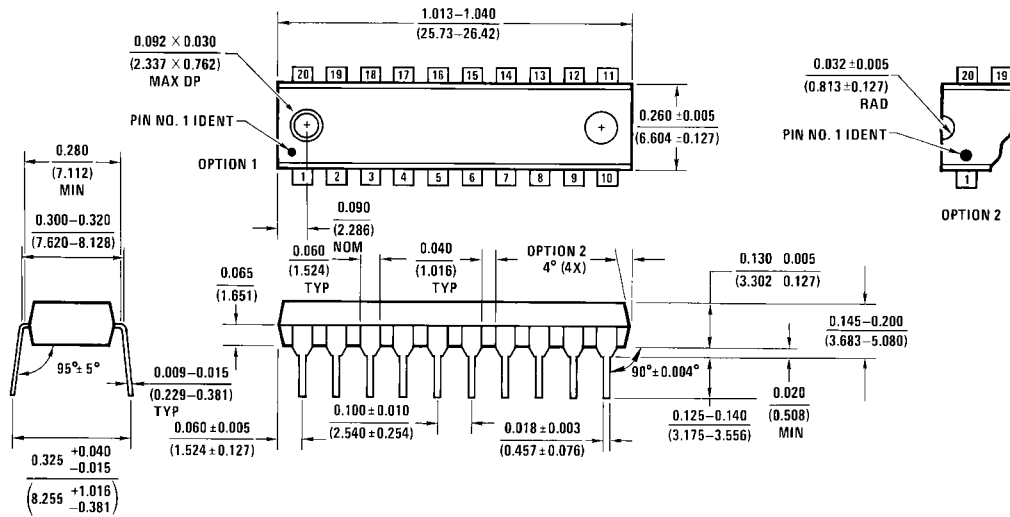

N20A (REV G)

**20-Lead Plastic Dual-In-Line Package (PDIP), JEDEC MS-001, 0.300" Wide  
Package Number N20A**

Fairchild does not assume any responsibility for use of any circuitry described, no circuit patent licenses are implied and Fairchild reserves the right at any time without notice to change said circuitry and specifications.

**LIFE SUPPORT POLICY**

FAIRCHILD'S PRODUCTS ARE NOT AUTHORIZED FOR USE AS CRITICAL COMPONENTS IN LIFE SUPPORT DEVICES OR SYSTEMS WITHOUT THE EXPRESS WRITTEN APPROVAL OF THE PRESIDENT OF FAIRCHILD SEMICONDUCTOR CORPORATION. As used herein:

1. Life support devices or systems are devices or systems which, (a) are intended for surgical implant into the body, or (b) support or sustain life, and (c) whose failure to perform when properly used in accordance with instructions for use provided in the labeling, can be reasonably expected to result in a significant injury to the user.
2. A critical component in any component of a life support device or system whose failure to perform can be reasonably expected to cause the failure of the life support device or system, or to affect its safety or effectiveness.

[www.fairchildsemi.com](http://www.fairchildsemi.com)