



Is Now Part of



**ON Semiconductor®**

To learn more about ON Semiconductor, please visit our website at  
[www.onsemi.com](http://www.onsemi.com)

ON Semiconductor and the ON Semiconductor logo are trademarks of Semiconductor Components Industries, LLC dba ON Semiconductor or its subsidiaries in the United States and/or other countries. ON Semiconductor owns the rights to a number of patents, trademarks, copyrights, trade secrets, and other intellectual property. A listing of ON Semiconductor's product/patent coverage may be accessed at [www.onsemi.com/site/pdf/Patent-Marking.pdf](http://www.onsemi.com/site/pdf/Patent-Marking.pdf). ON Semiconductor reserves the right to make changes without further notice to any products herein. ON Semiconductor makes no warranty, representation or guarantee regarding the suitability of its products for any particular purpose, nor does ON Semiconductor assume any liability arising out of the application or use of any product or circuit, and specifically disclaims any and all liability, including without limitation special, consequential or incidental damages. Buyer is responsible for its products and applications using ON Semiconductor products, including compliance with all laws, regulations and safety requirements or standards, regardless of any support or applications information provided by ON Semiconductor. "Typical" parameters which may be provided in ON Semiconductor data sheets and/or specifications can and do vary in different applications and actual performance may vary over time. All operating parameters, including "Typicals" must be validated for each customer application by customer's technical experts. ON Semiconductor does not convey any license under its patent rights nor the rights of others. ON Semiconductor products are not designed, intended, or authorized for use as a critical component in life support systems or any FDA Class 3 medical devices or medical devices with a same or similar classification in a foreign jurisdiction or any devices intended for implantation in the human body. Should Buyer purchase or use ON Semiconductor products for any such unintended or unauthorized application, Buyer shall indemnify and hold ON Semiconductor and its officers, employees, subsidiaries, affiliates, and distributors harmless against all claims, costs, damages, and expenses, and reasonable attorney fees arising out of, directly or indirectly, any claim of personal injury or death associated with such unintended or unauthorized use, even if such claim alleges that ON Semiconductor was negligent regarding the design or manufacture of the part. ON Semiconductor is an Equal Opportunity/Affirmative Action Employer. This literature is subject to all applicable copyright laws and is not for resale in any manner.



# NC7SP126

## TinyLogic® ULP Buffer with Three-State Output

### Features

- 0.9V to 3.6V  $V_{CC}$  Supply Operation
- 3.6V Over-Voltage Tolerant I/O's at  $V_{CC}$  from 0.9V to 3.6V
- Extremely High Speed  $t_{PD}$ 
  - 3.0ns: Typical for 3.0V to 3.6V  $V_{CC}$
  - 4.0ns: Typical for 2.3V to 2.7V  $V_{CC}$
  - 5.0ns: Typical for 1.65V to 1.95V  $V_{CC}$
  - 6.0ns: Typical for 1.4V to 1.6V  $V_{CC}$
  - 10.0ns: Typical for 1.1V to 1.3V  $V_{CC}$
  - 26.0ns: Typical for 0.9V  $V_{CC}$
- Power-Off High-Impedance Inputs and Outputs
- Static Drive ( $I_{OH}/I_{OL}$ )
  - $\pm 2.6$ mA at 3.00V  $V_{CC}$
  - $\pm 2.1$ mA at 2.30V  $V_{CC}$
  - $\pm 1.5$ mA at 1.65V  $V_{CC}$
  - $\pm 1.0$ mA at 1.4V  $V_{CC}$
  - $\pm 0.5$ mA at 1.1V  $V_{CC}$
  - $\pm 0.20$  $\mu$ A at 0.9V  $V_{CC}$
- Uses Proprietary Quiet Series™ Noise/EMI Reduction Circuitry
- Ultra-Small MicroPak™ Leadfree Package
- Ultra-Low Dynamic Power

### Description

The NC7SP126 is a single Buffer with 3-STATE output from Fairchild's Ultra-Low Power (ULP) series of TinyLogic®. Ideal for applications where battery life is critical, this product is designed for ultra-low power consumption within the  $V_{CC}$  operating range of 0.9V to 3.6V  $V_{CC}$ .

The internal circuit is composed of a minimum of inverter stages, including the output buffer, to enable ultra-low static and dynamic power.

The NC7SP126, for lower drive requirements, is uniquely designed for optimized power and speed, and is fabricated with an advanced CMOS technology to achieve best in class speed operation while maintaining extremely low CMOS power dissipation.

### Ordering Information

Part Number	Top Mark	Package	Packing Method
NC7SP126P5X	P26	5-Lead SC70, EIAJ SC-88a, 1.25mm Wide	3000 Units on Tape & Reel
NC7SP126L6X	L6	6-Lead MicroPak™, 1.00mm Wide	5000 Units on Tape & Reel
NC7SP126FHX	L6	6-Lead, MicroPak2™, 1x1mm Body, .35mm Pitch	5000 Units on Tape & Reel

TinyLogic® is a registered trademark of Fairchild Semiconductor Corporation.  
MicroPak™ and Quiet Series™ are trademarks of Fairchild Semiconductor Corporation.

# Battery Life

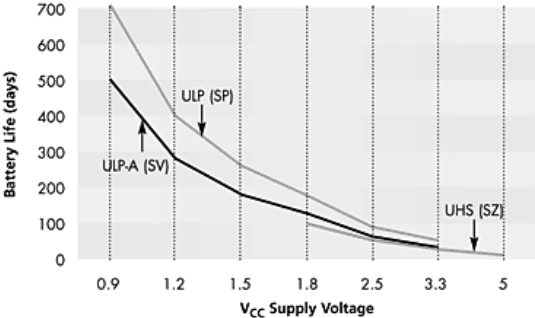

**Notes:**

1. TinyLogic® ULP and ULP-A with up to 50% less power consumption can extend your battery life significantly.  

$$\text{Battery Life} = (V_{\text{battery}} \cdot I_{\text{battery}} \cdot .9) / (P_{\text{device}}) / 24\text{hrs/day}$$
 Where,  $P_{\text{device}} = (I_{\text{CC}} \cdot V_{\text{CC}}) + (C_{\text{PD}} + C_{\text{L}}) \cdot V_{\text{CC}2} \cdot f.$
2. Assumes ideal 3.6V Lithium Ion battery with current rating of 900mAH and derated 90% and device frequency at 10MHz, with C<sub>L</sub> = 15pF load.

**Figure 1. Battery Life vs. V<sub>CC</sub> Supply Voltage**

# Connection Diagram



**Figure 2. Logic Symbol**

## Pin Configurations

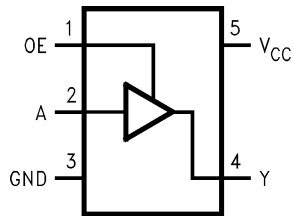

Figure 3. SC70 (Top View)

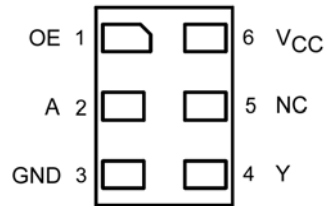

Figure 4. MicroPak™ (Top Through View)

## Pin Definitions

Pin # SC70	Pin # MicroPak™	Name	Description
1	1	OE	Input
2	2	A	Input
3	3	GND	Ground
4	4	Y	Output
5	6	V <sub>CC</sub>	Supply Voltage
	5	NC	No Connect

## Function Table

Inputs		Output
OE	A	Out Y
H	L	L
H	H	H
L	X	Z

H = HIGH Logic Level

L = LOW Logic Level

X = HIGH or LOW Logic Level

Z = HIGH Impedance State

## Absolute Maximum Ratings

Stresses exceeding the absolute maximum ratings may damage the device. The device may not function or be operable above the recommended operating conditions and stressing the parts to these levels is not recommended. In addition, extended exposure to stresses above the recommended operating conditions may affect device reliability. The absolute maximum ratings are stress ratings only.

Symbol	Parameter	Min.	Max.	Unit
$V_{CC}$	Supply Voltage	-0.5	4.6	V
$V_{IN}$	DC Input Voltage	-0.5	4.6	V
$V_{OUT}$	DC Output Voltage	HIGH or LOW State <sup>(3)</sup>	$V_{CC} + 0.5$	V
		$V_{CC}=0V$	4.6	
$I_{IK}$	DC Input Diode Current	$V_{IN} < 0V$	-50	mA
$I_{OK}$	DC Output Diode Current	$V_{OUT} < 0V$	-50	mA
		$V_{OUT} > V_{CC}$	+50	
$I_{OH}/I_{OL}$	DC Output Source/Sink Current		±50	mA
$I_{CC}$ or $I_{GND}$	DC $V_{CC}$ or Ground Current per Supply Pin		±50	mA
$T_{STG}$	Storage Temperature Range	-65	+150	°C
$T_J$	Junction Temperature under Bias		+150	°C
$T_L$	Junction Lead Temperature, Soldering 10 Seconds		+260	°C
$P_D$	Power Dissipation at +85°C	SC70-5	150	mW
		MicroPak™-6	130	
		MicroPak2™-6	120	
ESD	Human Body Model, JEDEC:JESD22-A114		4000	V
	Charge Device Model, JEDEC:JESD22-C101		2000	

**Note:**

- IO absolute maximum rating must be observed.

## Recommended Operating Conditions

The Recommended Operating Conditions table defines the conditions for actual device operation. Recommended operating conditions are specified to ensure optimal performance to the datasheet specifications. Fairchild does not recommend exceeding them or designing to Absolute Maximum Ratings.

Symbol	Parameter	Conditions	Min.	Max.	Unit
$V_{CC}$	Supply Voltage Operating		0.9	3.6	V
$V_{IN}$	Input Voltage		0	3.6	V
$V_{OUT}$	Output Voltage	$V_{CC}=0V$	0	3.6	V
		HIGH or LOW State	0	$V_{CC}$	
$I_{OH}/I_{OL}$	Output Current	$V_{CC}=3.0V$ to $3.6V$		±2.6	mA
		$V_{CC}=2.3V$ to $2.7V$		±2.1	
		$V_{CC}=1.65V$ to $1.95V$		±1.5	
		$V_{CC}=1.4V$ to $1.6V$		±1.0	
		$V_{CC}=1.1V$ to $1.3V$		±0.5	
		$V_{CC}=0.9V$		±20	µA
$T_A$	Operating Temperature, Free Air		-40	+85	°C
$\Delta t/\Delta V$	Minimum Input Edge Rate	$V_{IN}=0.8V$ to $2.0$ , $V_{CC}=3.0V$		10	ns/V
$\theta_{JA}$	Thermal Resistance	SC70-5		425	°C/W
		MicroPak™-6		500	
		MicroPak2™-6		560	

**Note:**

- Unused inputs must be held HIGH or LOW. They may not float.

### DC Electrical Characteristics

Symbol	Parameter	V <sub>CC</sub>	Conditions	T <sub>A</sub> =+25°C		T <sub>A</sub> =-40 to +85°C		Units
				Min.	Max.	Min.	Max.	
V <sub>IH</sub>	HIGH Level Input Voltage	0.90		.65 x V <sub>CC</sub>		.65 x V <sub>CC</sub>		V
		1.10 ≤ V <sub>CC</sub> ≤ 1.30		.65 x V <sub>CC</sub>		.65 x V <sub>CC</sub>		
		1.40 ≤ V <sub>CC</sub> ≤ 1.60		.65 x V <sub>CC</sub>		.65 x V <sub>CC</sub>		
		1.65 ≤ V <sub>CC</sub> ≤ 1.95		.65 x V <sub>CC</sub>		.65 x V <sub>CC</sub>		
		2.30 ≤ V <sub>CC</sub> ≤ 2.70		1.6		1.6		
		3.00 ≤ V <sub>CC</sub> ≤ 3.60		2.1		2.1		
V <sub>IL</sub>	LOW Level Input Voltage	0.90			.35 x V <sub>CC</sub>		.35 x V <sub>CC</sub>	V
		1.10 ≤ V <sub>CC</sub> ≤ 1.30			.35 x V <sub>CC</sub>		.35 x V <sub>CC</sub>	
		1.40 ≤ V <sub>CC</sub> ≤ 1.60			.35 x V <sub>CC</sub>		.35 x V <sub>CC</sub>	
		1.65 ≤ V <sub>CC</sub> ≤ 1.95			.35 x V <sub>CC</sub>		.35 x V <sub>CC</sub>	
		2.30 ≤ V <sub>CC</sub> ≤ 2.70			0.7		0.7	
		3.00 ≤ V <sub>CC</sub> ≤ 3.60			0.9		0.9	
V <sub>OH</sub>	HIGH Level Output Voltage	0.90	I <sub>OH</sub> =-20μA	V <sub>CC</sub> -0.1		V <sub>CC</sub> -0.1		V
		1.10 ≤ V <sub>CC</sub> ≤ 1.30		V <sub>CC</sub> -0.1		V <sub>CC</sub> -0.1		
		1.40 ≤ V <sub>CC</sub> ≤ 1.60		V <sub>CC</sub> -0.1		V <sub>CC</sub> -0.1		
		1.65 ≤ V <sub>CC</sub> ≤ 1.95		V <sub>CC</sub> -0.1		V <sub>CC</sub> -0.1		
		2.30 ≤ V <sub>CC</sub> ≤ 2.70		V <sub>CC</sub> -0.1		V <sub>CC</sub> -0.1		
		3.00 ≤ V <sub>CC</sub> ≤ 3.60		V <sub>CC</sub> -0.1		V <sub>CC</sub> -0.1		
		1.10 ≤ V <sub>CC</sub> ≤ 1.30	I <sub>OH</sub> =-0.5mA	.75 x V <sub>CC</sub>		.70 x V <sub>CC</sub>		
		1.40 ≤ V <sub>CC</sub> ≤ 1.60	I <sub>OH</sub> =-1mA	1.07		0.99		
		1.65 ≤ V <sub>CC</sub> ≤ 1.95	I <sub>OH</sub> =-1.5mA	1.24		1.22		
		2.30 ≤ V <sub>CC</sub> ≤ 2.70	I <sub>OH</sub> =-2.1mA	1.95		1.87		
3.00 ≤ V <sub>CC</sub> ≤ 3.60	I <sub>OH</sub> =-2.6mA	2.61		2.55				
V <sub>OL</sub>	LOW Level Output Voltage	0.90	I <sub>OL</sub> =20μA		0.1		0.1	V
		1.10 ≤ V <sub>CC</sub> ≤ 1.30			0.1		0.1	
		1.40 ≤ V <sub>CC</sub> ≤ 1.60			0.1		0.1	
		1.65 ≤ V <sub>CC</sub> ≤ 1.95			0.1		0.1	
		2.30 ≤ V <sub>CC</sub> ≤ 2.70			0.1		0.1	
		3.00 ≤ V <sub>CC</sub> ≤ 3.60			0.1		0.1	
		1.10 ≤ V <sub>CC</sub> ≤ 1.30	I <sub>OL</sub> =0.5mA		.30 x V <sub>CC</sub>		.30 x V <sub>CC</sub>	
		1.40 ≤ V <sub>CC</sub> ≤ 1.60	I <sub>OL</sub> =1mA		0.31		0.37	
		1.65 ≤ V <sub>CC</sub> ≤ 1.95	I <sub>OL</sub> =1.5mA		0.31		0.35	
		2.30 ≤ V <sub>CC</sub> ≤ 2.70	I <sub>OL</sub> =2.1mA		0.31		0.33	
		3.00 ≤ V <sub>CC</sub> ≤ 3.60	I <sub>OL</sub> =2.6mA		0.31		0.33	
		I <sub>IN</sub>	Input Leakage Current	0.90 to 3.60	0 ≤ V <sub>IN</sub> ≤ 3.60		±0.1	
I <sub>OZ</sub>	3-STATE Output Leakage	0.90 to 3.6	V <sub>IN</sub> =V <sub>IH</sub> or V <sub>IL</sub> 0 ≤ V <sub>IN</sub> ≤ 3.60		±0.5		±0.5	μA
I <sub>OFF</sub>	Power Off Leakage Current	0	0 ≤ (V <sub>IN</sub> , V <sub>O</sub> ) ≤ 3.60		0.5		0.5	μA
I <sub>CC</sub>	Quiescent Supply Current	0.90 to 3.60	V <sub>IN</sub> =V <sub>CC</sub> , or GND		0.9		0.9	μA

### AC Electrical Characteristics

Symbol	Parameter	V <sub>CC</sub>	Conditions	T <sub>A</sub> =+25°C			T <sub>A</sub> =-40 to +85°C		Units	Figure
				Min.	Typ.	Max.	Min.	Max.		
t <sub>PHL</sub> , t <sub>PLH</sub>	Propagation Delay	0.90	C <sub>L</sub> =10pF, R <sub>L</sub> =1MΩ		26				ns	Figure 5 Figure 6
		1.10 ≤ V <sub>CC</sub> ≤ 1.30		4.0	10.0	19.1	3.5	39.6		
		1.40 ≤ V <sub>CC</sub> ≤ 1.60		2.0	6.0	11.2	1.5	14.5		
		1.65 ≤ V <sub>CC</sub> ≤ 1.95		1.5	5.0	8.6	1.0	11.6		
		2.30 ≤ V <sub>CC</sub> ≤ 2.70		1.0	4.0	6.3	0.8	8.2		
		3.00 ≤ V <sub>CC</sub> ≤ 3.60		1.0	3.0	5.3	0.5	7.2		
t <sub>PZL</sub> , t <sub>PZH</sub>	Output Enable Time	0.90	C <sub>L</sub> =10pF, R <sub>U</sub> =5000Ω R <sub>D</sub> =5000Ω		29				ns	Figure 5 Figure 6
		1.10 ≤ V <sub>CC</sub> ≤ 1.30		4.0	8.0	17.5	3.5	40.4		
		1.40 ≤ V <sub>CC</sub> ≤ 1.60		2.0	6.0	11.9	1.5	14.8		
		1.65 ≤ V <sub>CC</sub> ≤ 1.95		1.5	5.0	9.7	1.0	12.3		
		2.30 ≤ V <sub>CC</sub> ≤ 2.70		1.0	4.0	7.7	0.8	10.5		
		3.00 ≤ V <sub>CC</sub> ≤ 3.60		1.0	3.0	6.9	0.5	8.6		
t <sub>PHZ</sub> , t <sub>PLZ</sub>	Output Disable Time	0.90	C <sub>L</sub> =10pF, R <sub>U</sub> =5000Ω R <sub>D</sub> =5000Ω		28				ns	Figure 5 Figure 6
		1.10 ≤ V <sub>CC</sub> ≤ 1.30		4.0	8.0	20.5	3.5	42.0		
		1.40 ≤ V <sub>CC</sub> ≤ 1.60		2.0	6.0	15.3	1.5	18.0		
		1.65 ≤ V <sub>CC</sub> ≤ 1.95		1.5	5.0	14.7	1.0	17.8		
		2.30 ≤ V <sub>CC</sub> ≤ 2.70		1.0	4.0	13.7	0.8	15.0		
		3.00 ≤ V <sub>CC</sub> ≤ 3.60		1.0	3.0	13.5	0.5	14.8		
t <sub>PHL</sub> , t <sub>PLH</sub>	Propagation Delay	0.90	C <sub>L</sub> =15pF, R <sub>L</sub> =1MΩ		28				ns	Figure 5 Figure 6
		1.10 ≤ V <sub>CC</sub> ≤ 1.30		5.0	10.0	20.5	4.5	42.5		
		1.40 ≤ V <sub>CC</sub> ≤ 1.60		3.0	7.0	11.8	2.5	15.4		
		1.65 ≤ V <sub>CC</sub> ≤ 1.95		2.0	5.0	9.1	2.0	12.2		
		2.30 ≤ V <sub>CC</sub> ≤ 2.70		1.5	4.0	6.6	1.0	8.6		
		3.00 ≤ V <sub>CC</sub> ≤ 3.60		1.0	3.0	5.6	0.5	7.5		
t <sub>PZL</sub> , t <sub>PZH</sub>	Output Enable Time	0.90	C <sub>L</sub> =15pF, R <sub>U</sub> =5000Ω R <sub>D</sub> =5000Ω		31				ns	Figure 5 Figure 6
		1.10 ≤ V <sub>CC</sub> ≤ 1.30		5.0	11.0	18.2	4.5	43.3		
		1.40 ≤ V <sub>CC</sub> ≤ 1.60		3.0	7.0	12.5	2.5	15.5		
		1.65 ≤ V <sub>CC</sub> ≤ 1.95		2.0	5.0	10.2	2.0	12.9		
		2.30 ≤ V <sub>CC</sub> ≤ 2.70		1.5	4.0	8.0	1.0	9.9		
		3.00 ≤ V <sub>CC</sub> ≤ 3.60		1.0	3.0	7.2	0.5	8.9		
t <sub>PHZ</sub> , t <sub>PLZ</sub>	Output Disable Time	0.90	C <sub>L</sub> =15pF, R <sub>U</sub> =5000Ω R <sub>D</sub> =5000Ω		30				ns	Figure 5 Figure 6
		1.10 ≤ V <sub>CC</sub> ≤ 1.30		5.0	11.0	21.6	4.5	44.9		
		1.40 ≤ V <sub>CC</sub> ≤ 1.60		3.0	7.0	15.9	2.5	18.8		
		1.65 ≤ V <sub>CC</sub> ≤ 1.95		2.0	5.0	15.2	2.0	18.2		
		2.30 ≤ V <sub>CC</sub> ≤ 2.70		1.5	4.0	14.1	1.0	15.4		
		3.00 ≤ V <sub>CC</sub> ≤ 3.60		1.0	3.0	13.9	0.5	15.1		

Continued on following page...

**AC Electrical Characteristics** (Continued)

Symbol	Parameter	V <sub>CC</sub>	Conditions	T <sub>A</sub> =+25°C			T <sub>A</sub> =-40 to +85°C			Units	Figure
				Min.	Typ.	Min.	Typ.	Min.			
t <sub>PHL</sub> , t <sub>PLH</sub>	Propagation Delay	0.90	C <sub>L</sub> =30pF, R <sub>L</sub> =1MΩ		34				ns	Figure 5 Figure 6	
		1.10 ≤ V <sub>CC</sub> ≤ 1.30		5.5	12.0	23.4	5.0	51.1			
		1.40 ≤ V <sub>CC</sub> ≤ 1.60		4.0	8.0	13.8	3.0	17.7			
		1.65 ≤ V <sub>CC</sub> ≤ 1.95		2.0	6.0	10.6	2.0	14.0			
		2.30 ≤ V <sub>CC</sub> ≤ 2.70		1.0	5.0	7.6	1.0	9.9			
		3.00 ≤ V <sub>CC</sub> ≤ 3.60		0.8	4.0	6.4	0.5	8.9			
t <sub>PZL</sub> , t <sub>PZH</sub>	Output Enable Time	0.90	C <sub>L</sub> =30pF, R <sub>U</sub> =5000Ω R <sub>D</sub> =5000Ω		37				ns	Figure 5 Figure 6	
		1.10 ≤ V <sub>CC</sub> ≤ 1.30		6.0	13.0	24.4	5.0	51.9			
		1.40 ≤ V <sub>CC</sub> ≤ 1.60		4.0	8.0	14.5	3.0	17.9			
		1.65 ≤ V <sub>CC</sub> ≤ 1.95		2.0	6.0	11.7	2.0	14.7			
		2.30 ≤ V <sub>CC</sub> ≤ 2.70		1.0	5.0	9.1	1.0	11.1			
		3.00 ≤ V <sub>CC</sub> ≤ 3.60		0.8	4.0	8.1	0.5	10.1			
t <sub>PHZ</sub> , t <sub>PLZ</sub>	Output Disable Time	0.90	C <sub>L</sub> =30pF, R <sub>U</sub> =5000Ω R <sub>D</sub> =5000Ω		36				ns	Figure 5 Figure 6	
		1.10 ≤ V <sub>CC</sub> ≤ 1.30		6.0	13.0	24.8	5.0	53.5			
		1.40 ≤ V <sub>CC</sub> ≤ 1.60		4.0	8.0	17.1	3.0	21.1			
		1.65 ≤ V <sub>CC</sub> ≤ 1.95		2.0	6.0	16.5	2.0	20.5			
		2.30 ≤ V <sub>CC</sub> ≤ 2.70		1.0	5.0	15.2	1.0	16.7			
		3.00 ≤ V <sub>CC</sub> ≤ 3.60		0.8	4.0	14.8	0.5	16.3			
C <sub>IN</sub>	Input Capacitance	0.00			2				pF		
C <sub>OUT</sub>	Output Capacitance	0.00			4				pF		
C <sub>PD</sub>	Power Dissipation Capacitance	0.90 to 3.60	V <sub>IN</sub> =0V or V <sub>CC</sub> , f=10MHz		8				pF		



## AC Loadings and Waveforms

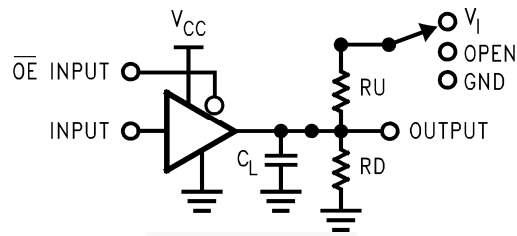

Figure 5. AC Test Circuit

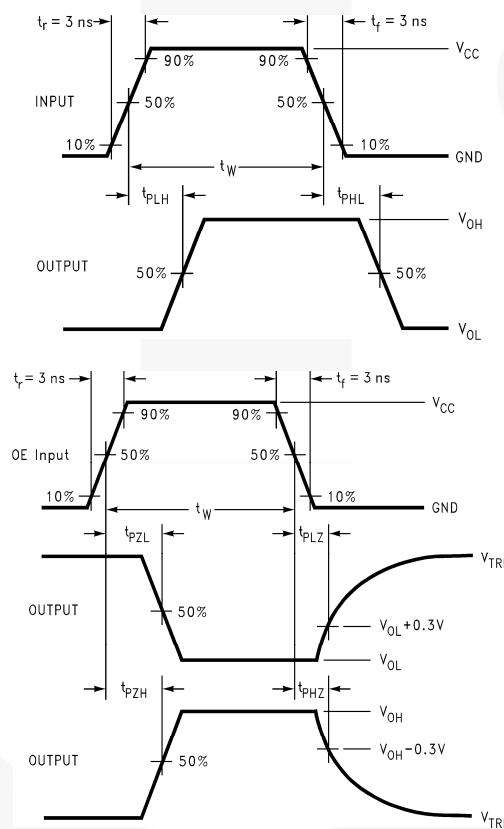
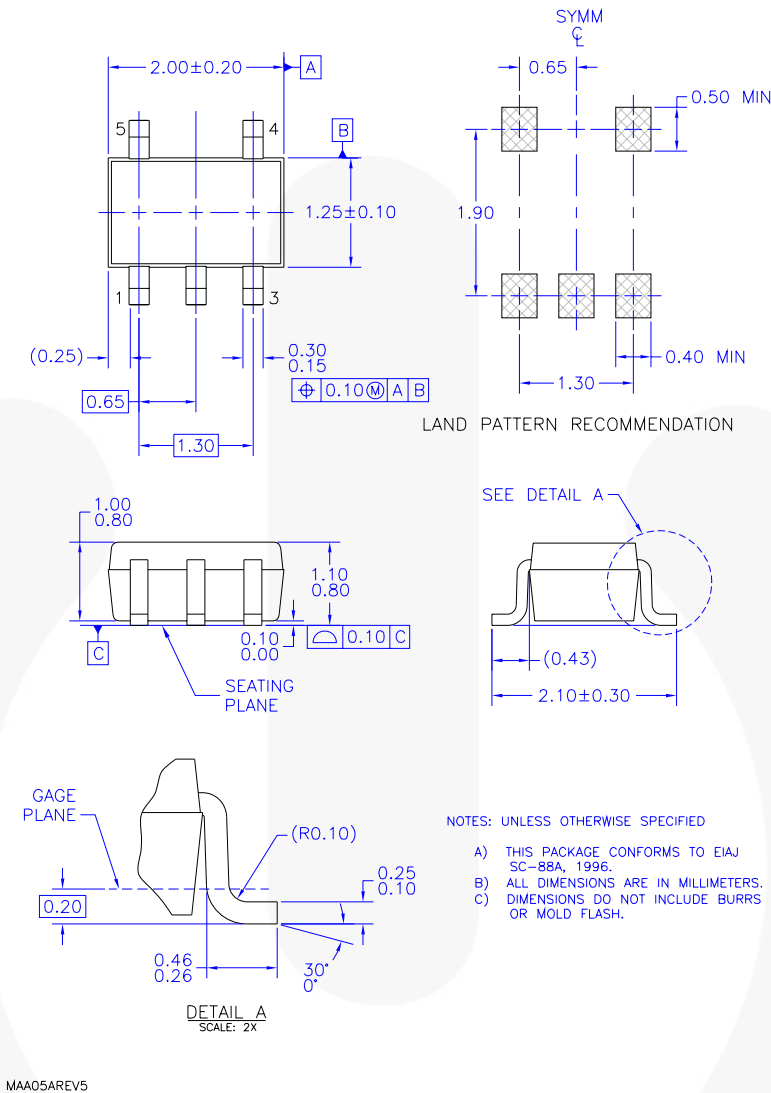

Figure 6. AC Waveforms

Symbol	$V_{CC}$					
	3.3V ± 0.3V	2.5V ± 0.2V	1.8V ± 0.15V	1.5V ± 0.10V	1.2V ± 0.10V	0.9V
$V_{mi}$	1.5V	$V_{CC}/2$	$V_{CC}/2$	$V_{CC}/2$	$V_{CC}/2$	$V_{CC}/2$
$V_{mo}$	0.3V	0.15V	0.15V	0.10V	0.10V	0.10V

## Physical Dimensions



**Figure 7. 5-Lead, SC70, EIAJ SC-88a, 1.25mm Wide**

Package drawings are provided as a service to customers considering Fairchild components. Drawings may change in any manner without notice. Please note the revision and/or date on the drawing and contact a Fairchild Semiconductor representative to verify or obtain the most recent revision. Package specifications do not expand the terms of Fairchild's worldwide terms and conditions, specifically the warranty therein, which covers Fairchild products.

Always visit Fairchild Semiconductor's online packaging area for the most recent package drawings:  
<http://www.fairchildsemi.com/packaging/>

## Tape and Reel Specification

Please visit Fairchild Semiconductor's online packaging area for the most recent tape and reel specifications:  
[http://www.fairchildsemi.com/products/analog/pdf/sc70-5\\_tr.pdf](http://www.fairchildsemi.com/products/analog/pdf/sc70-5_tr.pdf)

Package Designator	Tape Section	Cavity Number	Cavity Status	Cover Type Status
P5X	Leader (Start End)	125 (Typical)	Empty	Sealed
	Carrier	3000	Filled	Sealed
	Trailer (Hub End)	75 (Typical)	Empty	Sealed



## Physical Dimensions

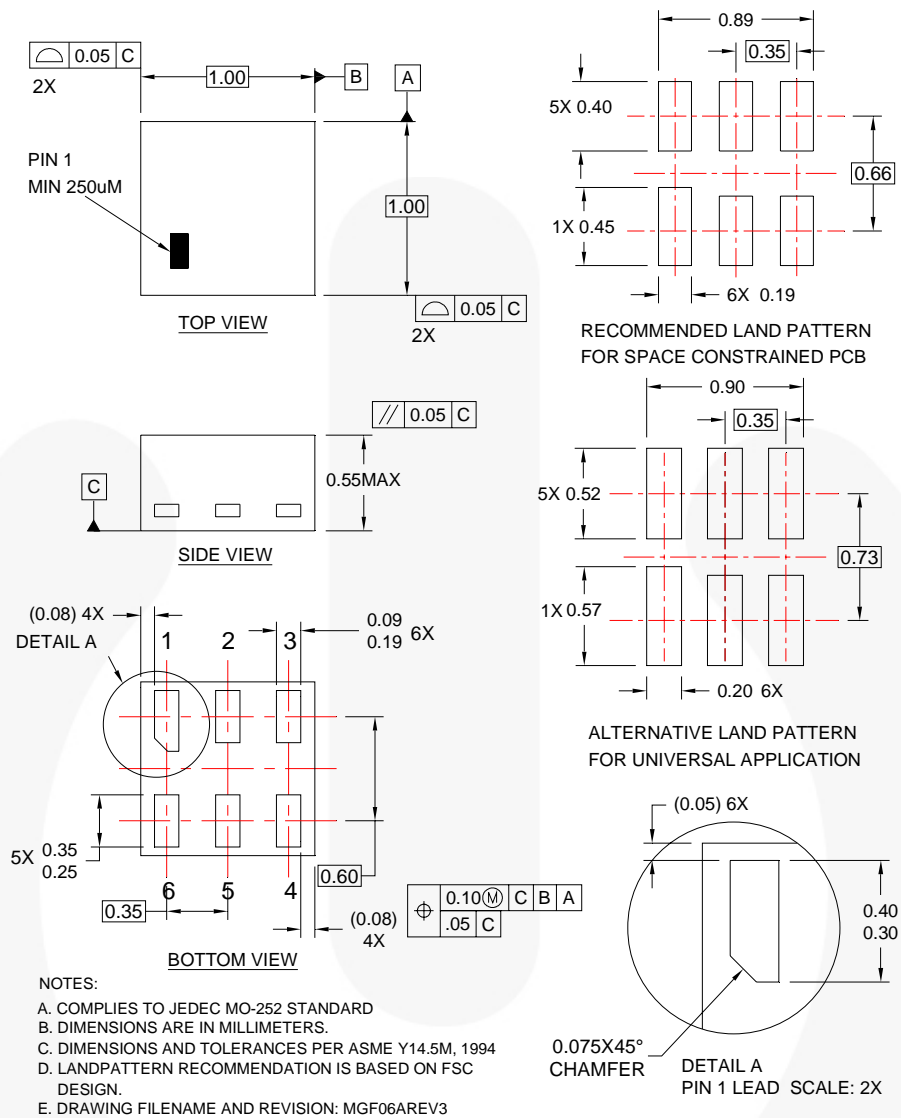

**Figure 9. 6-Lead, MicroPak2™, 1x1mm Body, .35mm Pitch**

Package drawings are provided as a service to customers considering Fairchild components. Drawings may change in any manner without notice. Please note the revision and/or date on the drawing and contact a Fairchild Semiconductor representative to verify or obtain the most recent revision. Package specifications do not expand the terms of Fairchild's worldwide terms and conditions, specifically the warranty therein, which covers Fairchild products.

Always visit Fairchild Semiconductor's online packaging area for the most recent package drawings:  
<http://www.fairchildsemi.com/packaging/>

## Tape and Reel Specifications





Please visit Fairchild Semiconductor's online packaging area for the most recent tape and reel specifications:  
[http://www.fairchildsemi.com/packaging/MicroPAK2\\_6L\\_tr.pdf](http://www.fairchildsemi.com/packaging/MicroPAK2_6L_tr.pdf)

Package Designator	Tape Section	Cavity Number	Cavity Status	Cover Type Status
FHX	Leader (Start End)	125 (Typical)	Empty	Sealed
	Carrier	5000	Filled	Sealed
	Trailer (Hub End)	75 (Typical)	Empty	Sealed



**TRADEMARKS**

The following includes registered and unregistered trademarks and service marks, owned by Fairchild Semiconductor and/or its global subsidiaries, and is not intended to be an exhaustive list of all such trademarks.

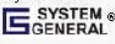
- |   |   |   |   |
|---|---|---|---|
| AccuPower™  | F-PFS™  | Power-SPM™  | The Power Franchise®  |
| Auto-SPM™   | FRFET®  | PowerTrench®  | The Right Technology for Your Success™  |
| AX-CAPT™  | Global Power Resource™  | PowerXS™  | <b>the power franchise</b>  |
| Build it Now™   | Green FPST™   | Programmable Active Droop™  | TinyBoost™  |
| CorePLUS™   | Green FPST™ e-Series™   | QFET®   | TinyBuck™   |
| CorePOWER™  | Gmax™   | QST™  | TinyCalc™   |
| CROSSVOL7™  | GTO™  | Quiet Series™   | TinyLogic®  |
| CTL™  | IntelliMAX™   | RapidConfigure™   | TINYOPTO™   |
| Current Transfer Logic™   | ISOPLANAR™  |  | TinyPower™  |
| DEUXPEED®   | MegaBuck™   | Saving our world, 1mW/kW at a time™   | TinyPWM™  |
| Dual Cool™  | MICROCOUPLER™   | SignalVise™   | TinyWire™   |
| EcoSPARK®   | MicroFET™   | SmartMax™   | TriFault Detect™  |
| EfficientMax™   | MicroPak™   | SMART START™  | TRUECURRENT™*   |
| ESBC™   | MicroPak2™  | SPM®  | µSerDes™  |
|  | MillerDrive™  | STEALTH™  |  |
| Fairchild®  | MotionMax™  | SuperFET®   | UHC®  |
| Fairchild Semiconductor®  | Motion-SPM™   | SuperSOT™.3   | Ultra FRFET™  |
| FACT Quiet Series™  | mWSaver™  | SuperSOT™.6   | UniFET™   |
| FACT®   | OptoHIT™  | SuperSOT™.8   | VCM™  |
| FAST®   | OPTOLOGIC®  | SupreMOS®   | VisualMax™  |
| FastvCore™  | OPTOPLANAR®   | SyncFET™  | XS™   |
| FETBench™   |  | Sync-Lock™  |   |
| FlashWriter®  | PDP SPM™  |  |   |
| FPST™   |   |   |   |

\* Trademarks of System General Corporation, used under license by Fairchild Semiconductor.

**DISCLAIMER**

FAIRCHILD SEMICONDUCTOR RESERVES THE RIGHT TO MAKE CHANGES WITHOUT FURTHER NOTICE TO ANY PRODUCTS HEREIN TO IMPROVE RELIABILITY, FUNCTION, OR DESIGN. FAIRCHILD DOES NOT ASSUME ANY LIABILITY ARISING OUT OF THE APPLICATION OR USE OF ANY PRODUCT OR CIRCUIT DESCRIBED HEREIN; NEITHER DOES IT CONVEY ANY LICENSE UNDER ITS PATENT RIGHTS, NOR THE RIGHTS OF OTHERS. THESE SPECIFICATIONS DO NOT EXPAND THE TERMS OF FAIRCHILD'S WORLDWIDE TERMS AND CONDITIONS, SPECIFICALLY THE WARRANTY THEREIN, WHICH COVERS THESE PRODUCTS.

**LIFE SUPPORT POLICY**

FAIRCHILD'S PRODUCTS ARE NOT AUTHORIZED FOR USE AS CRITICAL COMPONENTS IN LIFE SUPPORT DEVICES OR SYSTEMS WITHOUT THE EXPRESS WRITTEN APPROVAL OF FAIRCHILD SEMICONDUCTOR CORPORATION.

As used herein:

1. Life support devices or systems are devices or systems which, (a) are intended for surgical implant into the body or (b) support or sustain life, and (c) whose failure to perform when properly used in accordance with instructions for use provided in the labeling, can be reasonably expected to result in a significant injury of the user.
2. A critical component in any component of a life support, device, or system whose failure to perform can be reasonably expected to cause the failure of the life support device or system, or to affect its safety or effectiveness.

**ANTI-COUNTERFEITING POLICY**

Fairchild Semiconductor Corporation's Anti-Counterfeiting Policy. Fairchild's Anti-Counterfeiting Policy is also stated on our external website, [www.fairchildsemi.com](http://www.fairchildsemi.com), under Sales Support.

Counterfeiting of semiconductor parts is a growing problem in the industry. All manufacturers of semiconductor products are experiencing counterfeiting of their parts. Customers who inadvertently purchase counterfeit parts experience many problems such as loss of brand reputation, substandard performance, failed applications, and increased cost of production and manufacturing delays. Fairchild is taking strong measures to protect ourselves and our customers from the proliferation of counterfeit parts. Fairchild strongly encourages customers to purchase Fairchild parts either directly from Fairchild or from Authorized Fairchild Distributors who are listed by country on our web page cited above. Products customers buy either from Fairchild directly or from Authorized Fairchild Distributors are genuine parts, have full traceability, meet Fairchild's quality standards for handling and storage and provide access to Fairchild's full range of up-to-date technical and product information. Fairchild and our Authorized Distributors will stand behind all warranties and will appropriately address any warranty issues that may arise. Fairchild will not provide any warranty coverage or other assistance for parts bought from Unauthorized Sources. Fairchild is committed to combat this global problem and encourage our customers to do their part in stopping this practice by buying direct or from authorized distributors.

**PRODUCT STATUS DEFINITIONS**

**Definition of Terms**

Datasheet Identification	Product Status	Definition
Advance Information	Formative / In Design	Datasheet contains the design specifications for product development. Specifications may change in any manner without notice.
Preliminary	First Production	Datasheet contains preliminary data; supplementary data will be published at a later date. Fairchild Semiconductor reserves the right to make changes at any time without notice to improve design.
No Identification Needed	Full Production	Datasheet contains final specifications. Fairchild Semiconductor reserves the right to make changes at any time without notice to improve the design.
Obsolete	Not In Production	Datasheet contains specifications on a product that is discontinued by Fairchild Semiconductor. The datasheet is for reference information only.

Rev. 152