

PLEASE CHECK WWW.MOLEX.COM FOR LATEST PART INFORMATION

Part Number: [0003092022](#)
Status: **Active**
Overview: Standard .093" Pin and Socket Connectors
Description: 2.36mm Diameter Standard .093" Pin and Socket Plug Housing, 2 Circuits, without Mounting Ears

Documents:

[3D Model](#) [Product Specification PS-02-09 \(PDF\)](#)
[Drawing \(PDF\)](#) [RoHS Certificate of Compliance \(PDF\)](#)

Agency Certification

CSA LR19980
 UL E29179

General

Product Family Crimp Housings
 Series [1545](#)
 Application Power, Wire-to-Wire
 Comments Glow Wire Equivalent Part Number [50-36-1686](#). Polarized to Mating Part, 17.0A max. can be achieved when housing is used with 42477 or 42478 terminals
 Overview [Standard .093" Pin and Socket Connectors](#)
 Product Name Standard .093"
 UPC 800753614819

Physical

Breakaway No
 Circuits (maximum) 2
 Circuits Detail 1x2
 Color - Resin Natural
 Flammability 94V-2
 Gender Plug
 Glow-Wire Compliant No
 Keying to Mating Part None
 Lock to Mating Part Yes
 Material - Resin Nylon
 Net Weight 1.449/g
 Number of Rows 1
 Packaging Type Bag
 Panel Mount No
 Pitch - Mating Interface 6.30mm
 Pitch - Termination Interface 6.30mm
 Stackable No
 Temperature Range - Operating -40°C to +105°C

Electrical

Current - Maximum per Contact 14.0A

Solder Process Data

Lead-free Process Capability N/A

Material Info

Engineering Number 1545-P1

Reference - Drawing Numbers

Product Specification PS-02-09
 Sales Drawing SD-1545-*

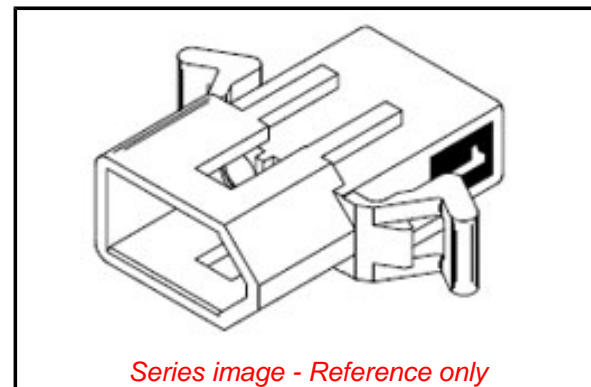

EU ELV

Not Relevant

EU RoHS

Compliant

REACH SVHC

Not Contained Per - ED/21/2016 (20 June 2016)

Halogen-Free

Status

Low-Halogen

Need more information on product environmental compliance?

Email productcompliance@molex.com
 Please visit the [Contact Us](#) section for any non-product compliance questions.

China ROHS
 ELV

Green Image
 Not Relevant

Search Parts in this Series

[1545](#) Series

Mates With

[03-09-1022](#) , [03-09-1027](#) , [03-09-1161](#) ,, [03-09-6021](#)

Use With

[1189](#) Crimp Terminals, [1190](#) Crimp Terminals, [1376](#) Male PC Tail Terminals, [1377](#) Female PC Tail Terminals, [1380](#) Male Crimp Terminals, [1381](#) Female Crimp Terminals, [1433](#) Crimp Terminals, [1434](#) Male Crimp Terminals, [1973](#) Male

This document was generated on 09/21/2016

PLEASE CHECK WWW.MOLEX.COM FOR LATEST PART INFORMATION