

PLEASE CHECK WWW.MOLEX.COM FOR LATEST PART INFORMATION

Part Number: [0355070700](#)
Status: **Active**
Overview: [Sherlock™ Connector System](#)
Description: 2.00mm Pitch Sherlock™ Wire-to-Board Housing, Natural, 7 Circuits

Documents:

3D Model	Product Specification PS-35507-003 (PDF)
Drawing (PDF)	Packaging Specification PK-35507-001 (PDF)
Product Specification PS-35507-001 (PDF)	RoHS Certificate of Compliance (PDF)
Product Specification PS-35507-002 (PDF)	

Agency Certification

CSA	LR19980
UL	E29179

General

Product Family	Crimp Housings
Series	35507
Application	Signal, Wire-to-Board
Overview	Sherlock™ Connector System
Product Name	Sherlock™
UPC	800753877641

Physical

Circuits (maximum)	7
Circuits Detail	7
Color - Resin	Natural
Flammability	94V-0
Gender	Female
Glow-Wire Compliant	No
Keying to Mating Part	None
Lock to Mating Part	Yes
Material - Resin	Polyester
Net Weight	0.300/g
Number of Rows	1
Packaging Type	Bag
Panel Mount	No
Pitch - Mating Interface	2.00mm
Polarized to Mating Part	Yes
Stackable	No
Temperature Range - Operating	-40°C to +105°C

Electrical

Current - Maximum per Contact	2.0A
-------------------------------	------

Material Info

Reference - Drawing Numbers

Packaging Specification	PK-35507-001
Product Specification	PS-35507-001, PS-35507-002, PS-35507-003, RPS-35507-003, RPS-35507-004, RPS-35507-005, RPS-35507-009, RPS-35507-010, RPS-35507-011, RPS-35507-014
Sales Drawing	SD-35507-001

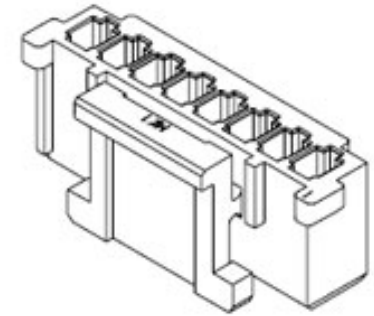

Series image - Reference only

EU ELV

Not Relevant

EU RoHS

Compliant

REACH SVHC

Not Contained Per -
ED/21/2016 (20 June
2016)

Halogen-Free

Status

Not Low-Halogen

**Need more information on product
environmental compliance?**

Email productcompliance@molex.com
Please visit the [Contact Us](#) section for any
non-product compliance questions.

China ROHS
ELV

Green Image
Not Relevant

Search Parts in this Series

[35507](#) Series

Mates With

Sherlock™ Wire-to-Board Header [35362](#) ,
[35363](#)

Use With

2.00mm Pitch Crimp Terminal [50212](#)

PLEASE CHECK WWW.MOLEX.COM FOR LATEST PART INFORMATION