

## Specification

Part Number:	MC42008A6W-FPTLW
Version:	1
Date:	16/06/2016

## Revision

MARK	DATE	DESCRIPTION	ITEM	PAGE	APPROVED
1	2016.03	INITIAL ISSUED	ALL	ALL	

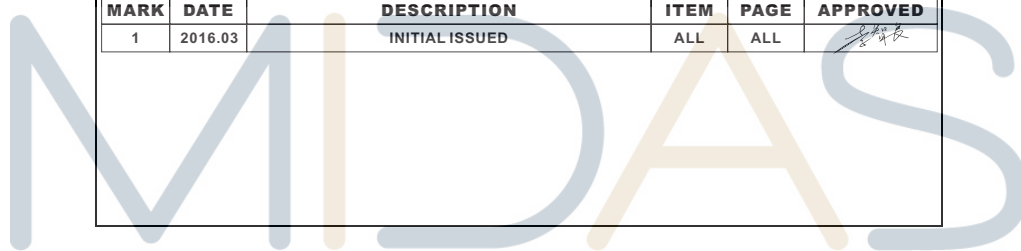

Character Layout	4 x 20
Appearance	Black on White
Logic Voltage	5V
Interface	Parallel i/f
Font Set	English / Japanese
Display Mode	Transflective
Character Height	8mm
LC Type	FSTN
Module Size W x H x D	146.00 x 62.50 x 14.50 mm
Operating Temperature	-20°C ~ +70°C
Construction	COB
LED Backlight	White LED



<b>CONTENTS</b>	<b>PAGE</b>
<b>DATASHEET STATEMENT</b>	<b>1</b>
<b>CODE SYSTEM</b>	<b>2</b>
<b>GENERAL SPECIFICATIONS</b> FEATURES MECHANICAL SPECIFICATIONS ABSOLUTE MAXIMUM RATINGS ELECTRONIC CHARACTERISTICS	<b>3</b>
<b>LCD PANEL CHARACTERISTICS</b>	<b>4</b>
<b>LED BACKLIGHT CHARACTERISTICS</b>	<b>4</b>
<b>LCD MODULE CHARACTERISTICS</b> PIN ASSIGNMENT BLOCK DIAGRAM POWER SUPPLY DIAGRAM	<b>5</b>
<b>FONT MAP</b>	<b>6</b>
<b>MECHANICAL DRAWING</b>	<b>7</b>
<b>PACKING DETAILS</b>	<b>8</b>

# MIDAS

design • manufacture • supply



# Midas LCD Part Number System

**MC COG 132033 A \* 6 W \* \* - S N T L W \* \***  
**1 2 3 4 5 6 7 8 9 - 10 11 12 13 14 15 16**

- 1 = **MC:** Midas Components
- 2 = **Blank:** COB (chip on board) **COG:** chip on glass
- 3 = **No of dots** (e.g. 240064 = 240 x 64 dots) (e.g. 21605 = 2 x 16 5mm C.H.)
- 4 = **Series**
- 5 = **Series Variant:** A to Z – see addendum
- 6 = **3:** 3 o'clock **6:** 6 o'clock **9:** 9 o'clock **12:** 12 o'clock
- 7 = **S:** Normal (0 to + 50 deg C) **W:** Wide temp. (-20 to + 70 deg C) **X:** Extended temp (-30 + 80 Deg C)
- 8 = **Character Set**  
**Blank:** Standard (English/Japanese)  
**C:** Chinese Simplified (Graphic Displays only)  
**CB:** Chinese Big 5 (Graphic Displays only)  
**H:** Hebrew  
**K:** European (std) (English/German/French/Greek)  
**L:** English/Japanese (special)  
**M:** European (English/Scandinavian)  
**R:** Cyrillic  
**W:** European (English/Greek)  
**U:** European (English/Scandinavian/Icelandic)  
**J:** Asian/Arabic
- 9 = **Bezel Height** (where applicable / available)
- |              | Top of Bezel to Top of PCB | Common (via pins 1 and 2) | Array or Edge Lit |
|--------------|----------------------------|---------------------------|-------------------|
| <b>Blank</b> | 9.5mm / not applicable     | Common                    | Array             |
| <b>2</b>     | 8.9 mm                     | Common                    | Array             |
| <b>3</b>     | 7.8 mm                     | Separate                  | Array             |
| <b>4</b>     | 7.8 mm                     | Common                    | Array             |
| <b>5</b>     | 9.5 mm                     | Separate                  | Array             |
| <b>6</b>     | 7 mm                       | Common                    | Array             |
| <b>7</b>     | 7 mm                       | Separate                  | Array             |
| <b>8</b>     | 6.4 mm                     | Common                    | Edge              |
| <b>9</b>     | 6.4 mm                     | Separate                  | Edge              |
| <b>A</b>     | 5.5 mm                     | Common                    | Edge              |
| <b>B</b>     | 5.5 mm                     | Separate                  | Edge              |
| <b>D</b>     | 6.0mm                      | Separate                  | Edge              |
| <b>E</b>     | 5.0mm                      | Separate                  | Edge              |
| <b>F</b>     | 4.7mm                      | Common                    | Edge              |
| <b>G</b>     | 3.7mm                      | Separate                  | EL                |
- 10 = **T:** TN **S:** STN **B:** STN Blue **G:** STN Grey **F:** FSTN **F2:** FFSTN **Z:** Zero Power (Bi-Stable) **V:** VA
- 11 = **P:** Positive **N:** Negative
- 12 = **R:** Reflective **M:** Transmissive **T:** Transflective
- 13 = **Backlight: Blank:** Reflective **L:** LED
- 14 = **Backlight Colour:** **Y:** Yellow-Green **W:** White **B:** Blue **R:** Red **A:** Amber **O:** Orange **G:** Green **RGB:** R.G.B.  
**If Z (Zero Power):** **WB:** White on blue **GB:** Green on black **YB:** Yellow on black **YPB:** Yellow on pink and/or blue
- 15 = **Driver Chip: Blank:** Standard **T:** Raio RA6963 **A:** Avant SAPI024B **R:** Raio RA8835
- 16 = **Interface: I:** I2C **S:** SPI **Blank:** Parallel
- 17 = **Voltage Variant:** e.g. **3** = 3v



## FEATURES

AVAILABLE OPTIONS	CHARACTERISTICS	CODE	No.
DISPLAY FORMAT	20 Characters by 4 Lines	MC42008A	1~6
POLARIZER OPTIONS	Positive Transflective	F	7
BACKLIGHT TYPE OPTIONS	Edge Type LED Backlight (Long life span version)	H	8
BACKLIGHT COLOR OPTIONS	White color	W	9
LCD PANEL OPTIONS	FSTN	F	10
VIEWING ANGLE OPTIONS	6:00 ( Bottom )	B	11
TEMPERATURE RANGE OPTIONS	-20°C ~ 70°C, Positive Voltage Driving Only	W	12
SUGGESTED DRIVING VOLTAGE	V <sub>lcm</sub> = 5.0V V <sub>led</sub> = 5.0V	5	13
SUGGESTED LED DRIVING MODE	PIN15: LED+, PIN16: LED-	1	14
CONTROLLER ▲1	SPLC780D + SPLC063A	L	15
FONT MAP CODE	E Version	E	16
DRIVING DUTY	1/16	—	—
DRIVING BIAS	1/5	—	—

▲1 Please ask for datasheet of the mentioned controller from 'AT & S' or 'AT & S' authorized distributors. You can find the related information including AC & DC characteristics, Write & Read Timing diagram, Instruction table and descriptions, DDRAM & CGRAM, Rest Function and so on from the datasheet of controller.

▲1 You can ask for the example of software program (C language) from 'AT & S' or 'AT & S' authorized distributors.

## MECHANICAL SPECIFICATIONS

OVERALL SIZE	146.0W x 62.5H	mm	THICKNESS	max 14.5	mm
VIEWING AREA	123.0W x 42.5H	mm	HOLE-HOLE	139.0W x 55.5H	mm
CHARACTER SIZE	4.84W x 9.22H	mm	CHARACTER PITCH	1.16W x 0.53H	mm
DOT SIZE	0.92W x 1.10H	mm	DOT PITCH	0.06W x 0.06H	mm

## ABSOLUTE MAXIMUM RATINGS

ITEM	SYMBOL	CONDITION	MIN	TYP	MAX	UNIT
POWER SUPPLY ( LOGIC)	V <sub>dd</sub>	25°C	-0.3	—	7.0	V
POWER SUPPLY (LCD)	V <sub>0</sub>	25°C	V <sub>dd</sub> -13.5	—	V <sub>dd</sub> +0.3	V
INPUT VOLTAGE	V <sub>in</sub>	25°C	-0.3	—	V <sub>dd</sub> +0.3	V
OPERATING TEMPERATURE	V <sub>opr</sub>	—	-20	—	70	°C
STORAGE TEMPERATURE	V <sub>stg</sub>	—	-30	—	80	°C

## ELECTRONIC CHARACTERISTICS

ICONS	ITEM	SYMBOL	CONDITION	MIN	TYP	MAX	UNIT
	INPUT VOLTAGE	V <sub>dd</sub>	—	—	5.0	—	V
	SUPPLY CURRENT	I <sub>dd</sub>	V <sub>dd</sub> =5V	—	1.5	—	mA
	DRIVING VOLTAGE FOR LCD PANEL	V <sub>lcd</sub> = (V <sub>dd</sub> - V <sub>0</sub> )	-20°C	4.00	—	4.40	V
			0°C	4.05	—	4.50	
			25°C	4.10	4.50	4.60	
			50°C	4.05	—	4.57	
			70°C	4.00	—	4.55	

All data are recorded from TEST REPORT #FSYP000200257

## LCD CHARACTERISTICS

FOR STN/FSTN TYPE LCD Panel (TA=25 °C, Vlcd=5.0V ± 0.5V)							
ICONS	ITEM	SYMBOL	CONDITION	MIN	TYP	MAX	UNIT
	VIEWING ANGLE	$\Phi 2 - \Phi 1$	K=4	40	—	—	deg
		$\theta$		60			
	CONTRAST RATIO	K	—	—	10	—	—
	RESPONSE TIME(RISE)	TR	—	—	150	250	ms
	RESPONSE TIME(FALL)	TF	—	—	150	250	ms

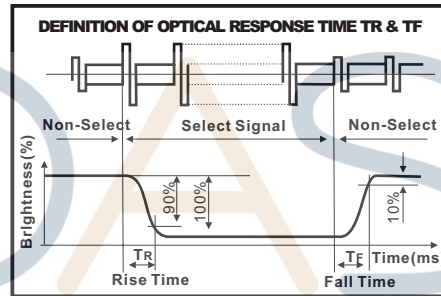
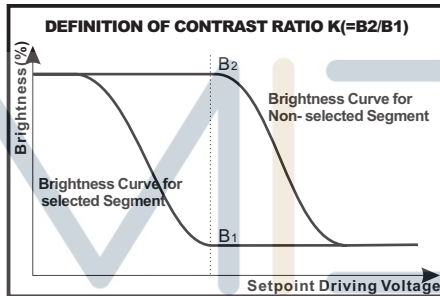
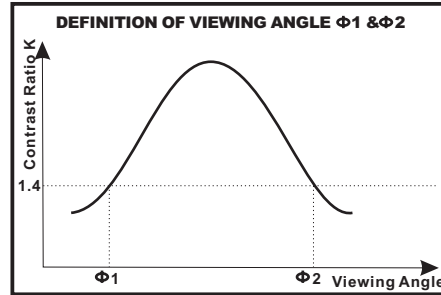
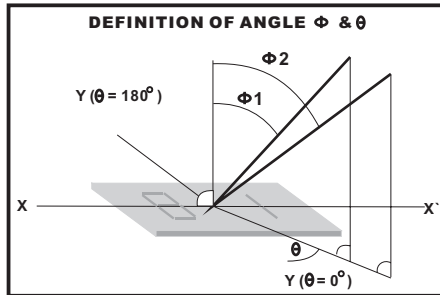

## LED CHARACTERISTICS

ICONS	ITEM	SYMBOL	CONDITION	MIN	TYP	MAX	UNIT
	LED FORWARD VOLTAGE	Vf	25°C If = 2*25mA	—	3.0	—	V
	LED FORWARD CURRENT ▲2	If	25°C	—	2*25	—	mA
	LED REVERSE CURRENT	Ir	25°C Vr=5.0V	—	—	100	μA
	LED COLOR RANGE	X coordinate	25°C If = 2*25mA	0.26	—	0.30	—
		Y coordinate		0.27	—	0.31	—
	LED BRIGHTNESS (WITHOUT LCD)	Lv	25°C If = 2*25mA	—	430	—	cd/m <sup>2</sup>
	LED BRIGHTNESS UNIFORMITY	Lvmin/Lvmax	25°C If = 2*25mA	70	—	—	Ratio
LED LIFE TIME ▲3	—	25°C If = 2*25mA	20K	—	—	Hours	

▲2 请注意, 驱动背光考虑的是恒流而不是恒压. 所以, 这个数值非常重要!

YOUR ATTENTION: It is constant current (not constant voltage) that should be applied when driving LED backlight. Therefore, this data is very important!

\* 当工作温度高于25 °C时, Ifm, Ifp和Pd必须降低; 电流降低率是 -0.36\*10mA/ °C (直流驱动), 或 -0.86\*10mA/ °C (脉冲驱动), 功率降低率是 -75\*10mW/ °C. 产品工作电流不能大于对应的工作条件温度Ifm或Ifpr的60%.

For operation above 25 °C, The Ifm Ifp & Pd must be derated, the Current derating is -0.36\*10mA/ °C for DC drive and -0.86\*10 mA/ °C for Pulse drive, the power dissipation is -75\*10 mW/ °C The product working current must not be more than 60% of the Ifm or Ifp according to the working temperature.

## PIN ASSIGNMENT

PIN	SYMBOL	DESCRIPTION	REMARKS
1	Vss	GND	
2	Vdd	Power supply for LCM	5.0V
3	V0	Contrast Adjust	
4	RS	Register Select Signal	
5	R/W	Data Read / Write	
6	E	Enable Signal	
7	DB0	Data bus line	
8	DB1	Data bus line	
9	DB2	Data bus line	
10	DB3	Data bus line	
11	DB4	Data bus line	
12	DB5	Data bus line	
13	DB6	Data bus line	
14	DB7	Data bus line	
15	LED+	Power supply for BKL	5.0V
16	LED-	Power supply for BKL	

## BLOCK DIAGRAM

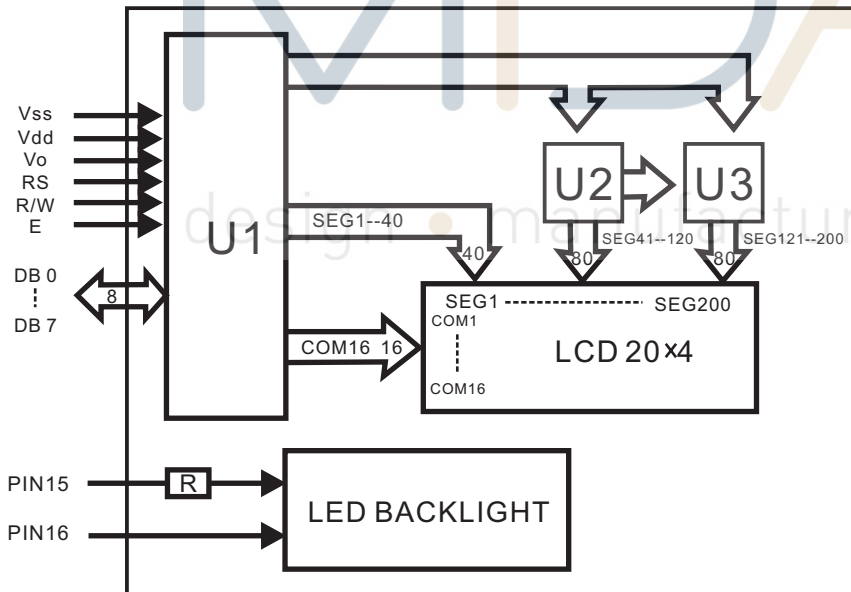

## POWER SUPPLY DIAGRAM

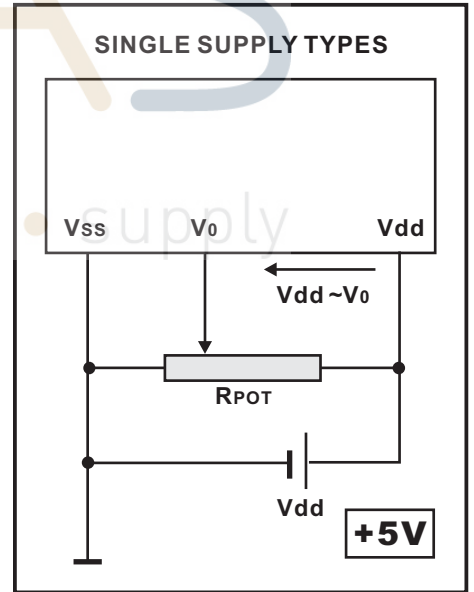

Upper 4bit Lower 4bit	LLLL	LLLH	LLHL	LLHH	LHLL	LHLH	LHHL	LHHH	HLLL	HLLH	HLHL	HLHH	HHLL	HHLH	HHHL	HHHH
LLLL	CG RAM (1)															
LLLH	(2)															
LLHL	(3)															
LLHH	(4)															
LHLL	(5)															
LHLH	(6)															
LHHL	(7)															
LHHH	(8)															
HLLL	(1)															
HLLH	(2)															
HLHL	(3)															
HLHH	(4)															
HHLL	(5)															
HHLH	(6)															
HHHL	(7)															
HHHH	(8)															



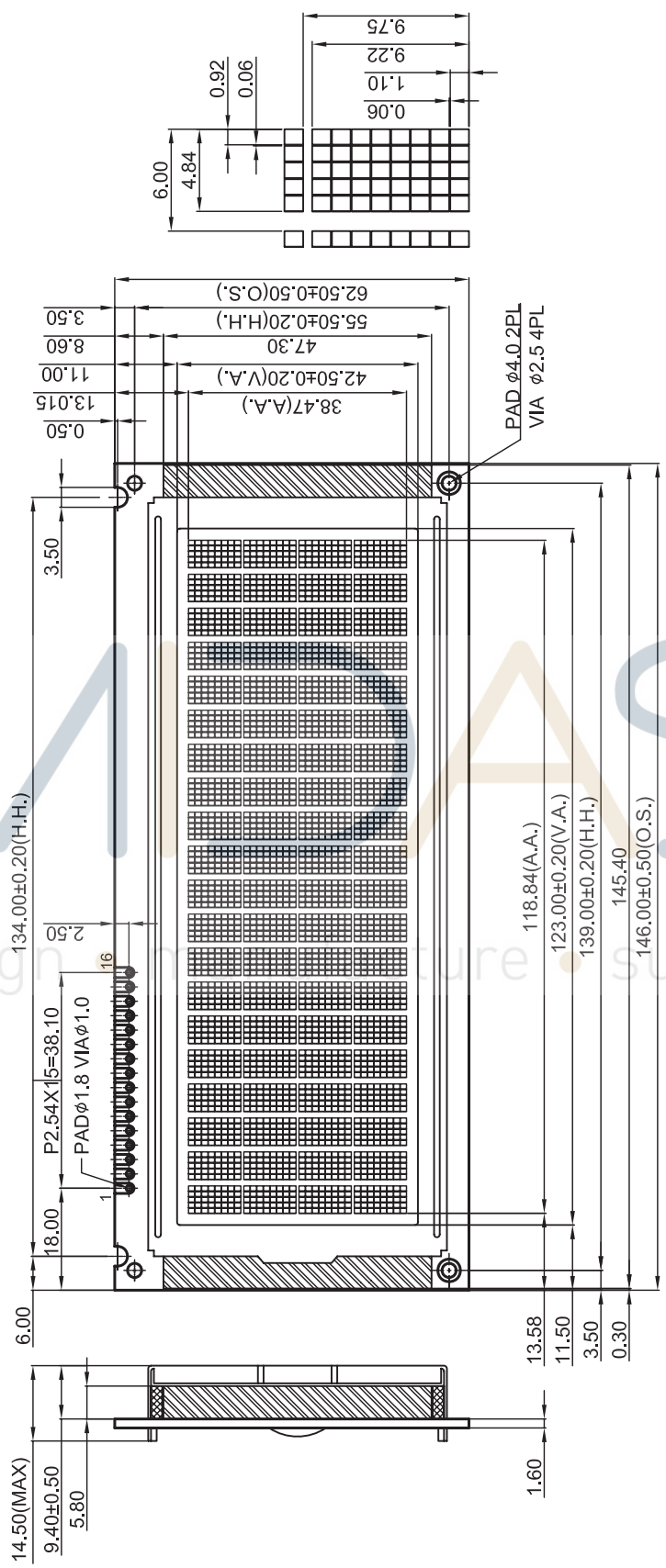

designature supply





FULL-SIZED PACKAGE
15 PCS/BOX
8 BOXES/CARTON
120 PCS/CARTON
18.00 KGS/CTN(G.W.)
0.054 M <sup>3</sup> /CARTON

HALF-SIZED PACKAGE
15 PCS/BOX
4 BOXES/CARTON
60 PCS/CARTON
9.00 KGS/CTN(G.W.)
0.027 M <sup>3</sup> /CARTON

PACKING DECLARATION
1. This packaging information is for reference only. The actual information is subject to the actual packaging. Especially for packaging of LCL, tolerances may exist.
2. T&A will not be responsible for quality problems caused by unnormal transportation conditions (including but not limited to climate factors or human factors, such as improper handling).

