

ATV320U15N4B

variable speed drive ATV320 - 1.5kW -
380...500V - 3 phase - book



Main

Range of product	Altivar Machine ATV320
Product or component type	Variable speed drive
Product specific application	Complex machines
Device short name	ATV320
Format of the control block	Book
Product destination	Asynchronous motors Synchronous motors
EMC filter	Class C2 EMC filter integrated
IP degree of protection	IP20 conforming to EN/IEC 61800-5-1
Type of cooling	Fan
Network number of phases	3 phases
[Us] rated supply voltage	380...500 V (- 15...10 %)
Supply frequency	50...60 Hz (- 5...5 %)
Motor power kW	1.5 kW for heavy duty
Motor power hp	2 hp for heavy duty
Line current	6.5 A at 380 V for heavy duty 4.9 A at 500 V for heavy duty
Prospective line I _{sc}	<= 5 kA
Apparent power	4.2 kVA at 500 V for heavy duty
Continuous output current	4.1 A at 4 kHz for heavy duty
Maximum transient current	6.2 A during 60 s for heavy duty
Asynchronous motor control profile	Voltage/Frequency ratio, 2 points Voltage/Frequency ratio, 5 points Flux vector control without sensor, standard Voltage/Frequency ratio - Energy Saving, quadratic U/f Flux vector control without sensor - Energy Saving
Synchronous motor control profile	Vector control without sensor
Speed drive output frequency	0.1...599 Hz
Nominal switching frequency	4 kHz
Switching frequency	2...16 kHz adjustable
Safety function	GDL (guard door locking) SMS (safe maximum speed) SS1 (safe stop 1) SLS (safe limited speed) STO (safe torque off) SIL 3

The information provided in this documentation contains general descriptions and/or technical characteristics of the performance of the products contained herein. This documentation is not intended as a substitute for and is not to be used for determining suitability or reliability of these products for specific user applications. It is the duty of any such user or integrator to perform the appropriate and complete risk analysis, evaluation and testing of the products with respect to the relevant specific application or use thereof. Neither Schneider Electric Industries SAS nor any of its affiliates or subsidiaries shall be responsible or liable for misuse of the information contained herein.

Communication port protocol	CANopen Modbus
Optional communication modules	Communication module: Ethernet Powerlink Communication module: Profinet Communication module: Profibus DP V1 Communication module: Ethernet/IP Communication module: DeviceNet Communication module: EtherCAT RJ45 Communication module: CANopen open style terminal block Communication module: CANopen SUB-D 9 Communication module: CANopen daisy chain RJ45

Complementary

Output voltage	\leq power supply voltage
Permissible temporary current boost	1.5 x In during 60 s for heavy duty
Speed range	1...100 with asynchronous motor in open-loop mode
Speed accuracy	+/- 10 % of nominal slip 0.2 Tn to Tn
Torque accuracy	+/- 15 %
Transient overtorque	170...200 % of nominal motor torque
Braking torque	< 170 % with braking resistor during 60 s
Regulation loop	Adjustable PID regulator
Motor slip compensation	Automatic whatever the load Not available in voltage/frequency ratio (2 or 5 points) Adjustable 0...300 %
Acceleration and deceleration ramps	S U CUS Deceleration ramp automatic stop DC injection Deceleration ramp adaptation Linear Ramp switching
Braking to standstill	By DC injection
Protection type	Drive: thermal protection Drive: short-circuit between motor phases Drive: overheating protection Drive: overcurrent between output phases and earth Drive: input phase breaks
Frequency resolution	Analog input: 0.012/50 Hz Display unit: 0.1 Hz
Electrical connection	Power supply, screw terminal: 1.5...4 mm ² AWG 14...AWG 10 Motor/Braking resistor, screw terminal: 1.5...2.5 mm ² AWG 14...AWG 12 Control, screw terminal: 0.5...1.5 mm ² AWG 18...AWG 14
Type of connector	1 RJ45 for Modbus/CANopen on front face
Physical interface	2-wire RS 485 for Modbus
Transmission frame	RTU for Modbus
Transmission rate	50 kbps, 125 kbps, 250 kbps, 500 kbps, 1 Mbps for CANopen 4.8, 9.6, 19.2, 38.4 kbit/s for Modbus
Data format	8 bits, configurable odd, even or no parity for Modbus
Type of polarization	No impedance for Modbus
Number of addresses	1...247 for Modbus 1...127 for CANopen
Method of access	Slave for CANopen
Supply	Internal supply for reference potentiometer (1 to 10 kOhm): 10.5 V DC (+/- 5 %) current \leq 10 mA (overload and short-circuit protection)
Local signalling	1 LED red for drive voltage 1 LED red for drive fault 1 LED red for CANopen error 1 LED green for CANopen run
Width	45 mm
Height	325 mm
Depth	245 mm
Product weight	2.5 kg
Analogue input number	3

Analogue input type	Current (AI3): 0...20 mA (or 4-20 mA, x-20 mA, 20-x mA or other patterns by configuration), impedance 250 Ohm, resolution 10 bits Bipolar differential voltage (AI2): +/- 10 V DC, impedance 30000 Ohm, resolution 10 bits Voltage (AI1): 0...10 V DC, impedance 30000 Ohm, resolution 10 bits
Discrete input number	7
Discrete input type	Safe torque off (STO): 24...30 V DC, impedance 1500 Ohm Switch-configurable PTC probe (DI6): 24...30 V DC Programmable as pulse input 20 kpps (DI5): 24...30 V DC: level 1 PLC Programmable (sink/source) (DI1...DI4): 24...30 V DC: level 1 PLC
Discrete input logic	Positive logic (source): : DI1...DI6, < 5 V (state 0) > 11 V (state 1) Negative logic (sink): : DI1...DI6, > 19 V (state 0) < 13 V (state 1)
Analogue output number	1
Analogue output type	Software-configurable voltage (AQ1): 0...10 V, impedance 470 Ohm, resolution 10 bits Software-configurable current (AQ1): 0...20 mA, impedance 800 Ohm, resolution 10 bits
Sampling duration	Analog output (AQ1): 2 ms Analog input (AI1, AI2, AI3): 2 ms
Accuracy	Analog output AQ1: +/- 2 % for a temperature of -10...60 °C Analog output AQ1: +/- 1 % for a temperature of 25 °C Analog input AI1, AI2, AI3: +/- 0.5 % for a temperature of 25 °C Analog input AI1, AI2, AI3: +/- 0.2 % for a temperature of -10...60 °C
Linearity error	Analog output (AQ1): +/- 0.3 % Analog input (AI1, AI2, AI3): +/- 0.2...0.5 % of maximum value
Discrete output number	3
Discrete output type	Logic (LO) Configurable relay logic NO (R2A, R2B): electrical durability 100000 cycles Configurable relay logic NO/NC (R1A, R1B, R1C): electrical durability 100000 cycles
Refresh time	Relay output (R2A, R2C): 2 ms Relay output (R1A, R1B, R1C): 2 ms Logic input (DI1...DI6): 8 ms (+/- 0.7 ms)
Minimum switching current	Relay output (R1, R2): 5 mA at 24 V DC
Maximum switching current	Relay output (R2) on resistive load (cos phi = 1): 5 A at 30 V DC Relay output (R2) on resistive load (cos phi = 1): 5 A at 250 V AC Relay output (R1, R2) on inductive load (cos phi = 0.4): 2 A at 30 V DC Relay output (R1, R2) on inductive load (cos phi = 0.4): 2 A at 250 V AC Relay output (R1) on resistive load (cos phi = 1): 4 A at 30 V DC Relay output (R1) on resistive load (cos phi = 1): 3 A at 250 V AC

Environment

Isolation	Between power and control terminals
Insulation resistance	> 1 mOhm at 500 V DC for 1 minute to earth
Noise level	43 dB conforming to 86/188/EEC
Power dissipation in W	63 W (fan) at 380 V, 4 kHz for heavy duty
Operating position	Vertical +/- 10 degree
Electromagnetic compatibility	Voltage dips and interruptions immunity test conforming to IEC 61000-4-11 Radiated radio-frequency electromagnetic field immunity test conforming to IEC 61000-4-3 level 3 Electrostatic discharge immunity test conforming to IEC 61000-4-2 level 3 Electrical fast transient/burst immunity test conforming to IEC 61000-4-4 level 4 Conducted radio-frequency immunity test conforming to IEC 61000-4-6 level 3 1.2/50 µs - 8/20 µs surge immunity test conforming to IEC 61000-4-5 level 3
Pollution degree	2 conforming to EN/IEC 61800-5-1
Vibration resistance	1.5 mm peak to peak (f = 3...13 Hz) conforming to EN/IEC 60068-2-6 1 gn (f = 13...200 Hz) conforming to EN/IEC 60068-2-6
Shock resistance	15 gn during 11 ms conforming to EN/IEC 60068-2-27
Relative humidity	5...95 % without dripping water conforming to IEC 60068-2-3 5...95 % without condensation conforming to IEC 60068-2-3
Ambient air temperature for operation	50...60 °C with derating factor -10...50 °C without derating
Ambient air temperature for storage	-25...70 °C
Operating altitude	1000...2000 m with current derating 1 % per 100 m <= 1000 m without derating

Standards	EN 61800-3 environment 2 category C2 EN 61800-3 environment 1 category C2 EN 55011 class A group 1 EN/IEC 61800-5-1 EN/IEC 61800-3
Product certifications	CSA NOM 117 UL RCM EAC
Marking	CE

Dimensions

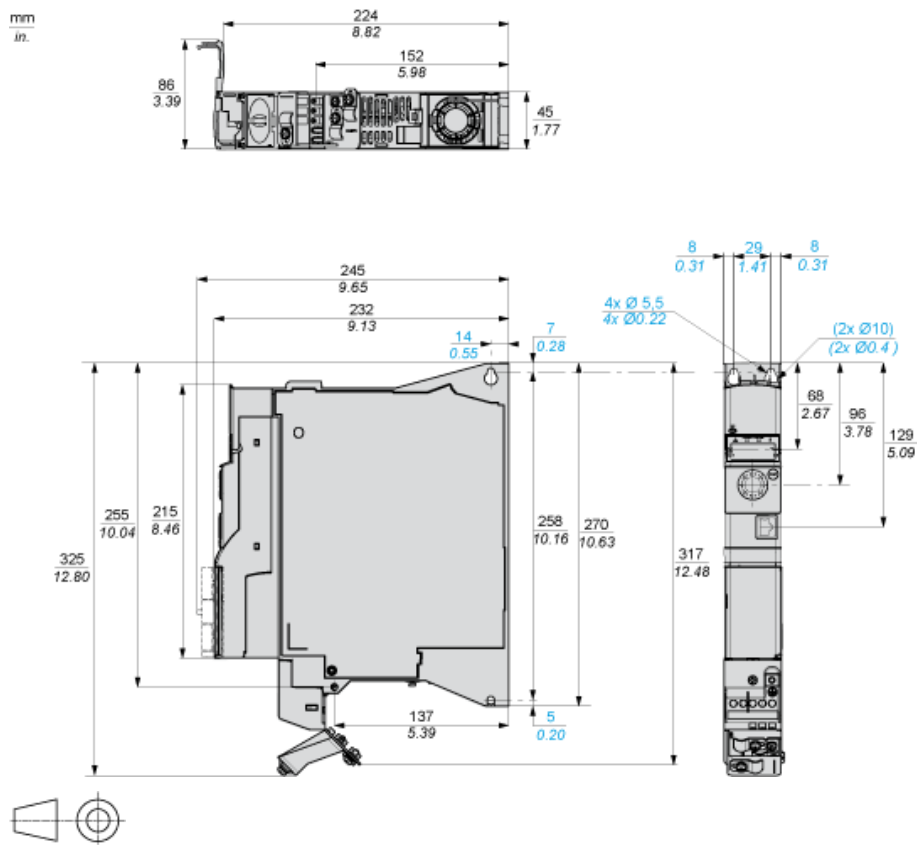

Mounting and Clearance

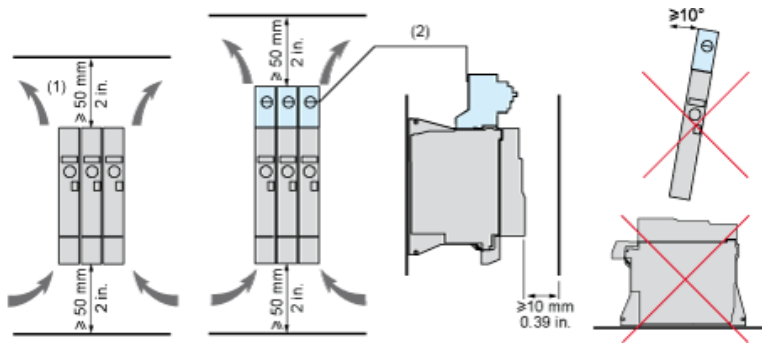

- (1) Minimum value corresponding to thermal constraints.
- (2) Optional GV2 circuit-breaker

Option: Protection Device, GV2 circuit-breaker

NOTE: The product overall height dimension, including GV2 adapter and EMC plate mounted, becomes 424 mm (16.7 in.) instead of 325 mm (12.80 in.)

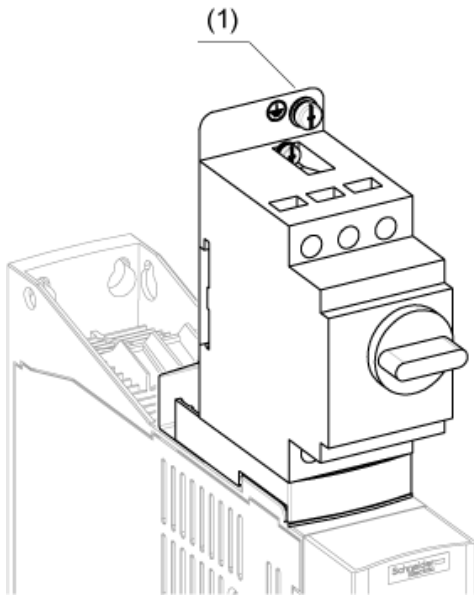

- (1) Ground screw (HS type 2 - 5x12)

Connection Diagrams

Diagram with Line Contactor

Connection diagrams conforming to standards EN 954-1 category 1 and IEC/EN 61508 capacity SIL1, stopping category 0 in accordance with standard IEC/EN 60204-1.



- (1) Line choke (if used)
- (2) Fault relay contacts, for remote signaling of drive status

Diagram with Switch Disconnect

Connection diagrams conforming to standards EN 954-1 category 1 and IEC/EN 61508 capacity SIL1, stopping category 0 in accordance with standard IEC/EN 60204-1.



- (1) Line choke (if used)
- (2) Fault relay contacts, for remote signaling of drive status

Control Connection Diagram in Source Mode

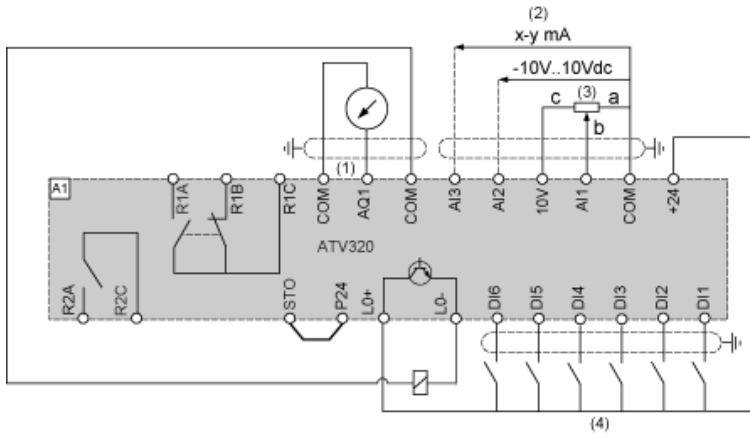

- (1) Analog output
- (2) Analog inputs
- (3) Reference potentiometer (10 kOhm maxi)
- (4) Digital inputs

Derating Curves

Derating curve for the nominal drive current (I_n) as a function of temperature and switching frequency (X).

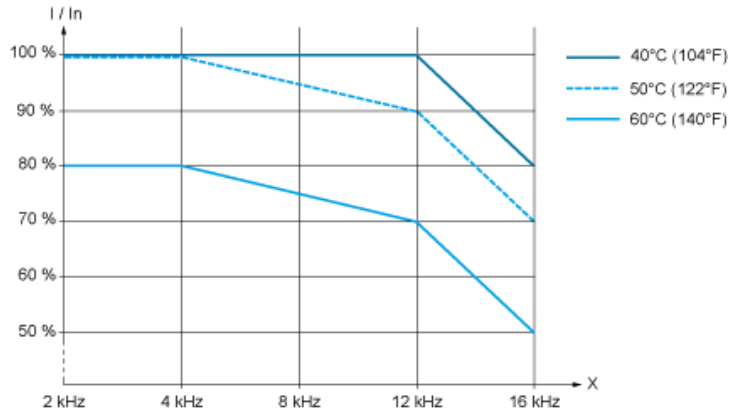

Sink / Source Switch Configuration (SW1)

The logic input switch (SW1) is used to adapt the operation of the logic inputs to the technology of the programmable controller outputs. Switch SW1 set to "SRC" position and use of the output power supply for the DIs.

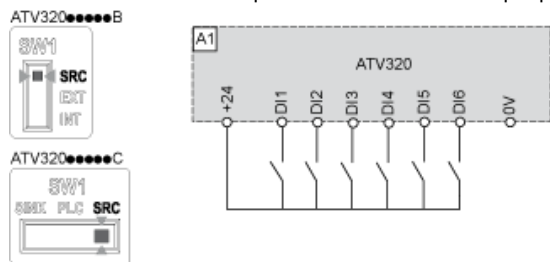

Switch SW1 set to "SRC" position and use of an external power supply for the DIs.

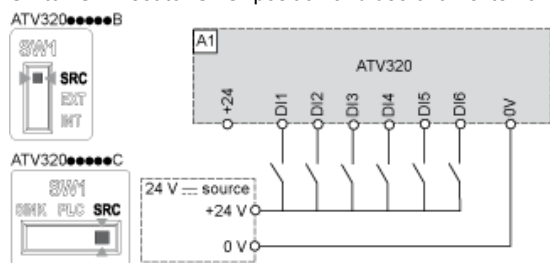

Switch SW1 set to "Sink Int" position and use of the output power supply for the DIs.

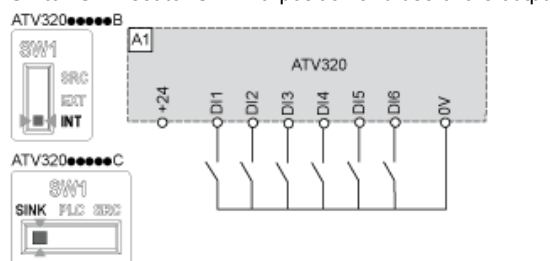

Switch SW1 set to "Sink Ext" position and use of an external power supply for the DIs.

