



Is Now Part of



**ON Semiconductor®**

To learn more about ON Semiconductor, please visit our website at  
[www.onsemi.com](http://www.onsemi.com)

ON Semiconductor and the ON Semiconductor logo are trademarks of Semiconductor Components Industries, LLC dba ON Semiconductor or its subsidiaries in the United States and/or other countries. ON Semiconductor owns the rights to a number of patents, trademarks, copyrights, trade secrets, and other intellectual property. A listing of ON Semiconductor's product/patent coverage may be accessed at [www.onsemi.com/site/pdf/Patent-Marking.pdf](http://www.onsemi.com/site/pdf/Patent-Marking.pdf). ON Semiconductor reserves the right to make changes without further notice to any products herein. ON Semiconductor makes no warranty, representation or guarantee regarding the suitability of its products for any particular purpose, nor does ON Semiconductor assume any liability arising out of the application or use of any product or circuit, and specifically disclaims any and all liability, including without limitation special, consequential or incidental damages. Buyer is responsible for its products and applications using ON Semiconductor products, including compliance with all laws, regulations and safety requirements or standards, regardless of any support or applications information provided by ON Semiconductor. "Typical" parameters which may be provided in ON Semiconductor data sheets and/or specifications can and do vary in different applications and actual performance may vary over time. All operating parameters, including "Typicals" must be validated for each customer application by customer's technical experts. ON Semiconductor does not convey any license under its patent rights nor the rights of others. ON Semiconductor products are not designed, intended, or authorized for use as a critical component in life support systems or any FDA Class 3 medical devices or medical devices with a same or similar classification in a foreign jurisdiction or any devices intended for implantation in the human body. Should Buyer purchase or use ON Semiconductor products for any such unintended or unauthorized application, Buyer shall indemnify and hold ON Semiconductor and its officers, employees, subsidiaries, affiliates, and distributors harmless against all claims, costs, damages, and expenses, and reasonable attorney fees arising out of, directly or indirectly, any claim of personal injury or death associated with such unintended or unauthorized use, even if such claim alleges that ON Semiconductor was negligent regarding the design or manufacture of the part. ON Semiconductor is an Equal Opportunity/Affirmative Action Employer. This literature is subject to all applicable copyright laws and is not for resale in any manner.



May 2015

QEE113 — Plastic Infrared Light Emitting Diode

# QEE113 Plastic Infrared Light Emitting Diode

## Features

- $\lambda = 940 \text{ nm}$
- Package Type = Sidelooker
- Chip Material = GaAs
- Matched Photosensor: QSE113
- Medium Wide Emission Angle,  $50^\circ$
- Package Material: Clear Epoxy
- High Output Power
- Gray dot marking on the top side

## Description

The QEE113 is a 940 nm GaAs LED encapsulated in a medium wide angle, plastic sidelooker package.

## Package Dimensions<sup>(1, 2)</sup>

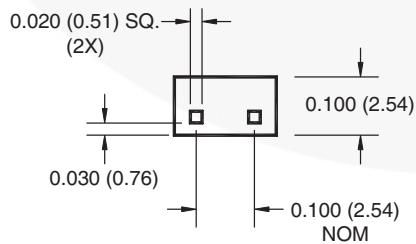
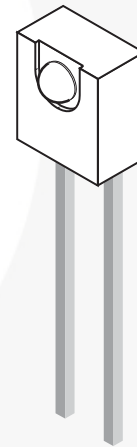
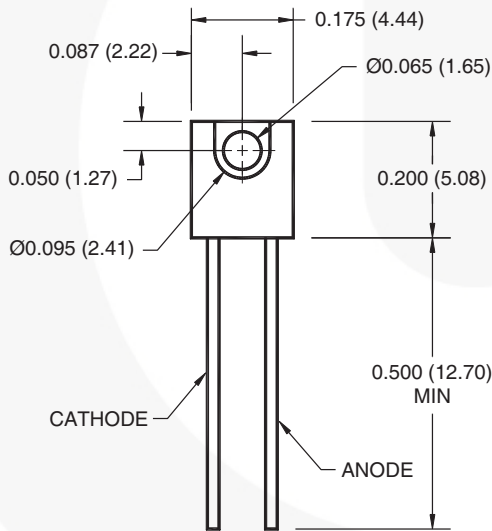

## Schematic

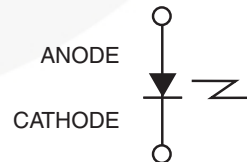

## Notes:

1. Dimensions for all drawings are in inches (mm).
2. Tolerance of  $\pm 0.010$  (0.25) on all non-nominal dimensions unless otherwise specified.

## Absolute Maximum Ratings

Stresses exceeding the absolute maximum ratings may damage the device. The device may not function or be operable above the recommended operating conditions and stressing the parts to these levels is not recommended. In addition, extended exposure to stresses above the recommended operating conditions may affect device reliability. The absolute maximum ratings are stress ratings only. Values are at  $T_A = 25^\circ\text{C}$  unless otherwise noted.

Symbol	Parameter	Value	Unit
$T_{\text{OPR}}$	Operating Temperature	-40 to +100	$^\circ\text{C}$
$T_{\text{STG}}$	Storage Temperature	-40 to +100	$^\circ\text{C}$
$T_{\text{SOL-I}}$	Soldering Temperature (Iron) <sup>(4, 5, 6)</sup>	240 for 5 sec	$^\circ\text{C}$
$T_{\text{SOL-F}}$	Soldering Temperature (Flow) <sup>(4, 5)</sup>	260 for 10 sec	$^\circ\text{C}$
$I_F$	Continuous Forward Current	50	mA
$V_R$	Reverse Voltage	5	V
$P_D$	Power Dissipation <sup>(3)</sup>	100	mW

### Notes:

- Derate power dissipation linearly 1.33 mW/ $^\circ\text{C}$  above  $25^\circ\text{C}$ .
- RMA flux is recommended.
- Methanol or isopropyl alcohols are recommended as cleaning agents.
- Soldering iron 1/16" (1.6mm) minimum from housing.

## Electrical / Optical Characteristics

Values are at  $T_A = 25^\circ\text{C}$  unless otherwise noted.

Symbol	Parameter	Conditions	Min.	Typ.	Max.	Unit
$\lambda_{\text{PE}}$	Peak Emission Wavelength	$I_F = 20 \text{ mA}$		945		nm
$\text{TC}_\lambda$	Temperature Coefficient			0.3		nm/ $^\circ\text{C}$
$2\theta^{1/2}$	Emission Angle	$I_F = 100 \text{ mA}$		50		$^\circ$
$V_F$	Forward Voltage	$I_F = 100 \text{ mA}$ , $t_p = 20 \text{ ms}$			1.5	V
$\text{TC}_{V_F}$	Temperature Coefficient			-2		mV/ $^\circ\text{C}$
$I_R$	Reverse Current	$V_R = 5 \text{ V}$			10	$\mu\text{A}$
$I_E$	Radiant Intensity	$I_F = 100 \text{ mA}$ , $t_p = 20 \text{ ms}$	3	7.5	12	mW/sr
$\text{TC}_{I_E}$	Temperature Coefficient			-0.7		%/ $^\circ\text{C}$
$t_r$	Rise Time	$I_F = 100 \text{ mA}$		800		ns
$t_f$	Fall Time			800		ns
$C_j$	Junction Capacitance	$V_R = 0 \text{ V}$		14		pF

## Typical Performance Characteristics

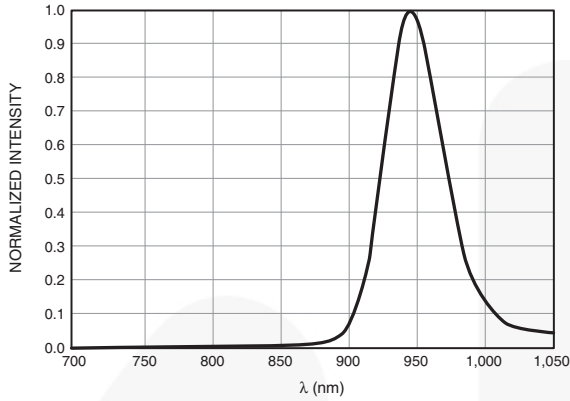

**Figure 1. Normalized Intensity vs. Wavelength**

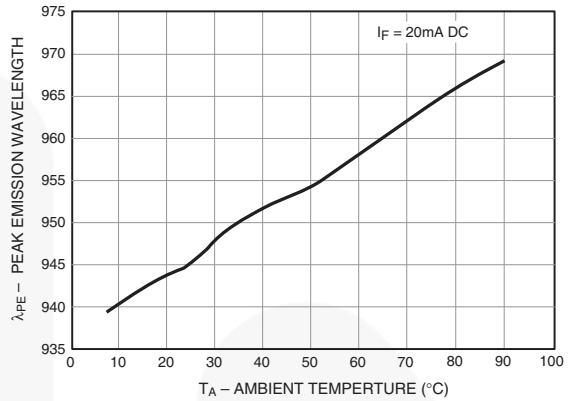

**Figure 2. Peak Wavelength vs. Ambient Temperature**

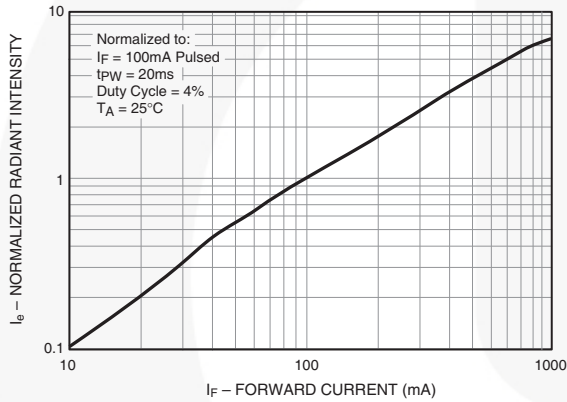

**Figure 3. Normalized Radiant Intensity vs. Forward Current**

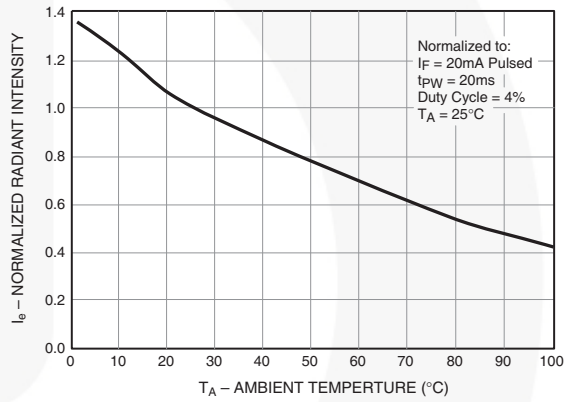

**Figure 4. Normalized Radiant Intensity vs. Ambient Temperature**

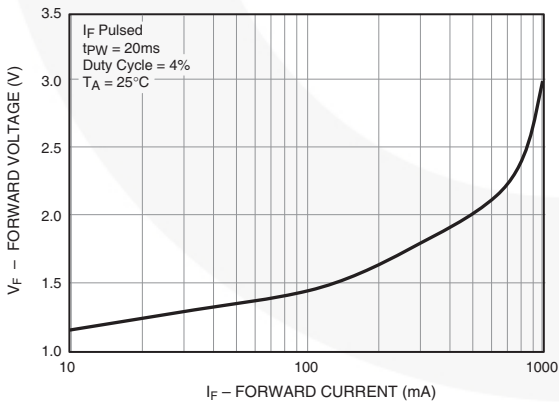

**Figure 5. Forward Voltage vs. Forward Current**

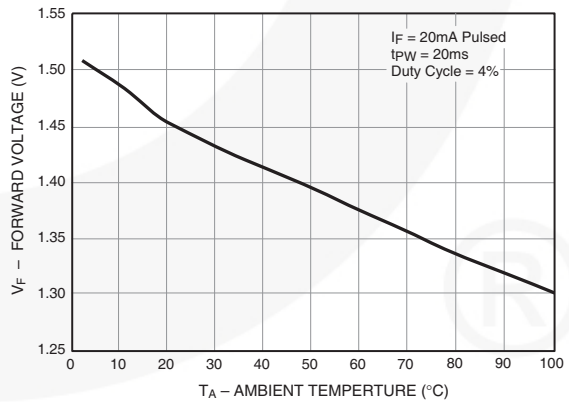

**Figure 6. Forward Voltage vs. Ambient Temperature**

Typical Performance Characteristics (Continued)

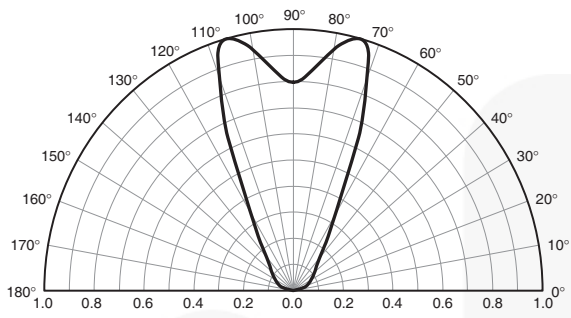

Figure 7. Radiation Diagram

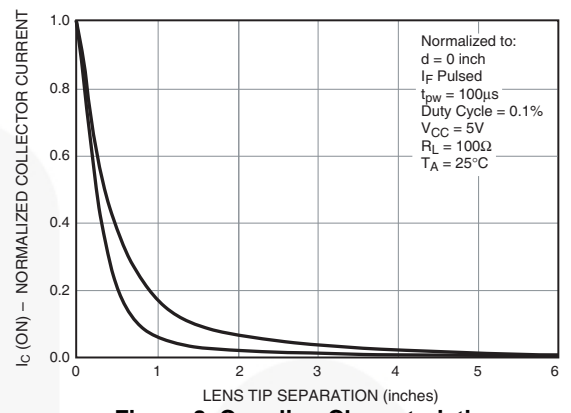

Figure 8. Coupling Characteristics of QEE113 and QSE113



## TRADEMARKS

The following includes registered and unregistered trademarks and service marks, owned by Fairchild Semiconductor and/or its global subsidiaries, and is not intended to be an exhaustive list of all such trademarks.

AccuPower™  
 AttitudeEngine™  
 Awinda®  
 AX-CAP®\*  
 BitSiC™  
 Build it Now™  
 CorePLUS™  
 CorePOWER™  
 CROSSVOLT™  
 CTL™  
 Current Transfer Logic™  
 DEUXPEED®  
 Dual Cool™  
 EcoSPARK®  
 EfficientMax™  
 ESBC™  
  
 Fairchild®  
 Fairchild Semiconductor®  
 FACT Quiet Series™  
 FACT®  
 FAST®  
 FastvCore™  
 FETBench™  
 FPS™

F-PFS™  
 FRFET®  
 Global Power Resource™  
 GreenBridge™  
 Green FPS™  
 Green FPS™ e-Series™  
 Gmax™  
 GTO™  
 IntelliMAX™  
 ISOPLANAR™  
 Making Small Speakers Sound Louder and Better™  
 MegaBuck™  
 MICROCOUPLER™  
 MicroFET™  
 MicroPak™  
 MicroPak2™  
 MillerDrive™  
 MotionMax™  
 MotionGrid®  
 MTi®  
 MTx®  
 MVN®  
 mWSaver®  
 OptoHiT™  
 OPTOLOGIC®

OPTOPLANAR®  
  
 Power Supply WebDesigner™  
 PowerTrench®  
 PowerXS™  
 Programmable Active Droop™  
 QFET®  
 QS™  
 Quiet Series™  
 RapidConfigure™  
  
 Saving our world, 1mW/W/kW at a time™  
 SignalWise™  
 SmartMax™  
 MicroPak™  
 SMART START™  
 Solutions for Your Success™  
 SPM®  
 STEALTH™  
 SuperFET®  
 SuperSOT™-3  
 SuperSOT™-6  
 SuperSOT™-8  
 SupreMOS®  
 SyncFET™  
 Sync-Lock™

 SYSTEM GENERAL®  
 TinyBoost®  
 TinyBuck®  
 TinyCalc™  
 TinyLogic®  
 TINYOPTO™  
 TinyPower™  
 TinyPWM™  
 TinyWire™  
 TranSiC™  
 TriFault Detect™  
 TRUECURRENT®\*  
 μSerDes™  
  
 UHC®  
 Ultra FRFET™  
 UniFET™  
 VCX™  
 VisualMax™  
 VoltagePlus™  
 XS™  
 Xsens™  
 仙童™

\* Trademarks of System General Corporation, used under license by Fairchild Semiconductor.

## DISCLAIMER

FAIRCHILD SEMICONDUCTOR RESERVES THE RIGHT TO MAKE CHANGES WITHOUT FURTHER NOTICE TO ANY PRODUCTS HEREIN TO IMPROVE RELIABILITY, FUNCTION, OR DESIGN. TO OBTAIN THE LATEST, MOST UP-TO-DATE DATASHEET AND PRODUCT INFORMATION, VISIT OUR WEBSITE AT <http://www.fairchildsemi.com>. FAIRCHILD DOES NOT ASSUME ANY LIABILITY ARISING OUT OF THE APPLICATION OR USE OF ANY PRODUCT OR CIRCUIT DESCRIBED HEREIN; NEITHER DOES IT CONVEY ANY LICENSE UNDER ITS PATENT RIGHTS, NOR THE RIGHTS OF OTHERS. THESE SPECIFICATIONS DO NOT EXPAND THE TERMS OF FAIRCHILD'S WORLDWIDE TERMS AND CONDITIONS, SPECIFICALLY THE WARRANTY THEREIN, WHICH COVERS THESE PRODUCTS.

## LIFE SUPPORT POLICY

FAIRCHILD'S PRODUCTS ARE NOT AUTHORIZED FOR USE AS CRITICAL COMPONENTS IN LIFE SUPPORT DEVICES OR SYSTEMS WITHOUT THE EXPRESS WRITTEN APPROVAL OF FAIRCHILD SEMICONDUCTOR CORPORATION.

As used herein:

1. Life support devices or systems are devices or systems which, (a) are intended for surgical implant into the body or (b) support or sustain life, and (c) whose failure to perform when properly used in accordance with instructions for use provided in the labeling, can be reasonably expected to result in a significant injury of the user.
2. A critical component in any component of a life support, device, or system whose failure to perform can be reasonably expected to cause the failure of the life support device or system, or to affect its safety or effectiveness.

## ANTI-COUNTERFEITING POLICY

Fairchild Semiconductor Corporation's Anti-Counterfeiting Policy. Fairchild's Anti-Counterfeiting Policy is also stated on our external website, [www.fairchildsemi.com](http://www.fairchildsemi.com), under Sales Support.

Counterfeiting of semiconductor parts is a growing problem in the industry. All manufacturers of semiconductor products are experiencing counterfeiting of their parts. Customers who inadvertently purchase counterfeit parts experience many problems such as loss of brand reputation, substandard performance, failed applications, and increased cost of production and manufacturing delays. Fairchild is taking strong measures to protect ourselves and our customers from the proliferation of counterfeit parts. Fairchild strongly encourages customers to purchase Fairchild parts either directly from Fairchild or from Authorized Fairchild Distributors who are listed by country on our web page cited above. Products customers buy either from Fairchild directly or from Authorized Fairchild Distributors are genuine parts, have full traceability, meet Fairchild's quality standards for handling and storage and provide access to Fairchild's full range of up-to-date technical and product information. Fairchild and our Authorized Distributors will stand behind all warranties and will appropriately address any warranty issues that may arise. Fairchild will not provide any warranty coverage or other assistance for parts bought from Unauthorized Sources. Fairchild is committed to combat this global problem and encourage our customers to do their part in stopping this practice by buying direct or from authorized distributors.

## PRODUCT STATUS DEFINITIONS

### Definition of Terms

Datasheet Identification	Product Status	Definition
Advance Information	Formative / In Design	Datasheet contains the design specifications for product development. Specifications may change in any manner without notice.
Preliminary	First Production	Datasheet contains preliminary data; supplementary data will be published at a later date. Fairchild Semiconductor reserves the right to make changes at any time without notice to improve design.
No Identification Needed	Full Production	Datasheet contains final specifications. Fairchild Semiconductor reserves the right to make changes at any time without notice to improve the design.
Obsolete	Not In Production	Datasheet contains specifications on a product that is discontinued by Fairchild Semiconductor. The datasheet is for reference information only.

Rev. 174