

**FEATURES**

- -40 to +105°C (-40 to +221°F) measurement range
- Celsius or Fahrenheit readings
- Supplied with thermistor probe
- Installs in round "oiltight" 1.20 inch (30.5mm) cutouts
- Operates from 24Vac or 6 to 50Vdc supplies
- Reverse polarity protected to -75Vdc
- Four-digit LED display with °C and °F annunciators
- Over-temperature and open/shorted thermistor indication
- Two display brightness settings: 3mA (lo) 5mA (hi)
- Screw-style terminal blocks simplify installation
- Self-resetting internal fuse for long term reliability
- Front panel moisture resistance to IP67/NEMA 6
- Supplied with EPDM rubber gasket and plastic hex nut
- Panel knockout punches and tooling available

**Performance/Functional Specifications**

Typical at Ta = +25°C, V<sub>supply</sub> = 12-24Vdc or 24Vac (50-60Hz), unless otherwise noted

**Power Supply (TB1)**

DC Input ①	+6 to +50Vdc
AC Input ①	24Vac (47-63Hz), ±15%
Reverse Polarity Protection	-75Vdc (min.)
Current Consumption	Low brightness: 4.5mA (max.) High brightness: 6mA (max.)

**NTC Thermistor® (TB2)**

Resistance at +25°C	10kΩ, ±3% (max.)
B <sub>25/100</sub>	3988K, ±0.5%
Time Constant	20 seconds (typ.)
Operating Temperature	-40 to +105°C
Insulation Resistance (100V)	100 MΩ (min.)

**Performance**

Sampling Rate	1 reading/second
Resolution	1 degree Fahrenheit or Celsius
Accuracy ③ at +72.0°F (+22.2°C)	±1° (typical), ±2° (max.)
Celsius Measurement Range ③	-35 to +105°C
Fahrenheit Measurement Range ③	-31 to +221°F
Overrange Indication	See footnote ④
Temperature Drift (from -25 to +60°C)	±0.03 counts/°C (typ.)

**Mechanical**

Dimensions	1.5 in. diameter x 1.0 depth in. (38.1 x 25.4mm)
Display Type	Four digit, LED, 0.30 in. (7.6mm)
Weight	0.74 ounces (21 grams) with nut, gasket, and thermistor probe
Housing Material	Polycarbonate
Terminal Block Torque (TB1 & TB2)	2.2 in.-lbs (0.25 N-m) ±20%
Wire size and Type	18-26AWG (1mm <sup>2</sup> to 0.14mm <sup>2</sup> ) copper, solid or stranded
Wire Insulation Strip Length	0.20 in. (5.1mm)

**Environmental**

Operating Temperature ⑤	-25 to +60°C
Storage Temperature	-40 to +75°C
Humidity (non-condensing)	0 to 85% (thermometer and probe)



Murata Power Solutions' new DMR20-1-TMP thermistor-input thermometer modules provide a simple cost-effective way to accurately measure air temperatures from -40 to +221°F (-40 to +105°C). The user can choose between Celsius or Fahrenheit readings via a rear pc-board jumper. Each thermometer is supplied with an epoxy-dipped NTC thermistor probe and is factory-calibrated to a typical accuracy of ±1°F. The probe features 18 inch (46cm) long leads to allow for remote installation.

Operating power can be from either 24Vac (50/60Hz) or 6 to 50V DC supplies. Two display-brightness levels are provided to ensure optimal readability under various ambient lighting environments. Typical power consumption from a 12 or 24Vdc supply is 3mA in the low brightness setting, and 5mA in the high-brightness setting. A built-in resettable fuse assures long term reliability, and all units are reverse polarity protected to -75Vdc.

Their large, 0.30 in./7.6mm, bright LED displays can be easily read from 10 feet away (3 meters). Visual indications alert the user to over / under temperature conditions, as well as an open or shorted thermistor. DMR20-1-TMP thermometers employ a precision 0.2% voltage reference and metal-film resistors to achieve outstanding performance over an operating ambient temperature range of -25 to +60°C.

The DMR20-1-TMP features a round polycarbonate housing that provides excellent protection against moisture, dust, shock and vibration. The supplied hardware is designed to provide moisture ingress protection to IP67/NEMA 6. Panel installation is straightforward: using available tooling, punch a 1.2 inch (30.5mm) diameter hole, insert the thermometer and gasket into the panel, and securely fasten using the supplied plastic hex nut.

- ① Operation and accuracy at supply voltages above or below this range are not specified.
- ② DMR20-1-TMP series thermometers are supplied with a 10k Ohm NTC thermistor probe that has a maximum operating temperature of +221°F (+105°C). The thermistor must not be immersed in fluids of any kind, including water.
- ③ The accuracy and measurement range specifications cited are achieved with the factory-supplied 10k Ohm NTC thermistor probe. Measurements at temperatures in the range of -32°F to -40°F (-36°C to -40°C) will decrease the accuracy to ±3° max. Measurements at temperatures in the range of +221°F to +230°F (+105°C to +110°C) will decrease the accuracy to ±3° max.
- ④ Overrange condition: measurements from -41°F (-41°C) to -50°F (-46°C) will cause the display intensity to flash from bright to dim to indicate a low temperature overrange condition where accuracy is no longer valid nor specified. Measurements from +221°F (+105°C) to +230°F (+110°C) will also cause the display intensity to flash from bright to dim to indicate a high temperature overrange condition, but accuracy is still valid to ±3° max. An open or shorted thermistor condition at terminal block TB2 will be displayed as ---°F or ---°C. Measurements below -50°F (-46°C) or above +230°F (+110°C) will also be displayed as an open or shorted thermistor.
- ⑤ -25 to +60°C is the operating temperature range of the DMR20-1-TMP module, and not the measurement range of the supplied NTC thermistor probe.



For full details go to [www.murata-ps.com/rohs](http://www.murata-ps.com/rohs)

**Ordering Information**

**DMR20-1-TMP-R-C** Digital Thermometer (Red LED) with NTC Thermistor

**Tooling**

<b>DMR20-1-KP</b>	1.2 in. (30.5mm) Round knockout punch (no keying notch)
<b>DMR20-2-KP</b>	1.2 in. 930.5mm) Round knockout punch (with four keying notches)
<b>DMR20-3-KP</b>	1/8 in. and 3/16 in. (3.2 and 4.7mm) key-notch nibbler tool

Note: An M30 x 1.5 nylon hex nut and EPDM sealing gasket are supplied with each thermometer. The “-C” suffix denotes RoHS compliance.

**TECHNICAL NOTES**



**IMPORTANT! To ensure safe and reliable operation, DMR20-1-TMP thermometers must be installed and serviced by qualified technical personnel. Contact Murata Power Solutions if there is any doubt regarding installation or operation.**

**1. Operating Input Range:** As shipped, the DMR20-1-TMP is configured for degrees Fahrenheit readings with jumper JP2 closed as indicated by the LED display's °F annunciator. Removing JP2 from its 2-position header (i.e., opening it) places the unit in the degrees Celsius reading mode and turns on the °C annunciator.

Jumper JP1 selects either the display low brightness mode (JP1 out or open), or the high brightness mode (JP1 in or closed).

Configuration changes to jumpers JP1 and JP2 should only be made when the unit is off (de-energized).

**2. Thermistor Probe Considerations:** Terminal block TB2 is internally connected to a high-impedance amplifier which, in some operating environments, may be susceptible to noise that produces unsteady or erratic temperature readings. Please note, the thermistor probe and its wire leads are not electrically isolated from the power source connected to TB1.

Operation in humid environments is permissible up to a relative humidity of 85% as long as condensation does not form on the thermistor probe body or the thermometer itself. The supplied thermistor probe must never come in direct contact with any liquids, solvents, or corrosive substances.

**3. Calibration:** DMR20-1-TMP thermometers are calibrated with the factory-supplied NTC thermistor probe connected to TB2. Under normal operating conditions, periodic recalibration is not required. The supplied thermistor probe's ±3% tolerance is nulled by adjusting the rear-mounted CAL potentiometer R3. Recalibration must always be performed if the supplied thermistor is replaced with another 10k Ohm NTC thermistor that meets the  $B_{25/100} = 3988K (\pm 0.5\%)$  specification. Operation and performance with thermistors that do not fully meet the thermal characteristics of the factory supplied probe are not specified.

To achieve the best overall accuracy, calibration should be performed with the unit configured for Fahrenheit reading (JP2 closed), with the probe at an ambient temperature of 72°F, ±6° (22°C, ±4°), adjusting R3 to match the readings of a user-supplied thermometer with known accuracy and a resolution of 0.1°F as a reference.

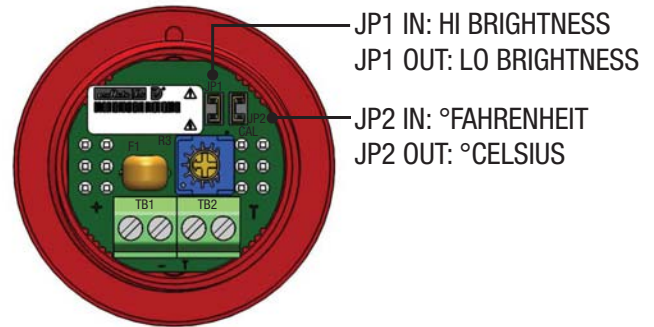

Figure 1. Jumper configuration

**4. Panel Installation:** Other than the factory-supply thermistor probe connected to TB2, all electrical connections to DMR20-1-TMP must be made after the unit is securely attached to the panel, and with its DC supply input de-energized (off). In high-vibration environments, adequate strain reliefs must be used on all wiring connected to TB1 and TB2. See Figure 2 for typical panel mounting details.

**Tightening Torque:**

The recommended tightening torque for the M30 x 1.5 plastic hex nut is 10 to 17 in-lbs (1.3 to 1.9 N-m). If a torque wrench is not available, this recommended range can be approximated by hand tightening the hex nut clockwise until it just bottoms out against the panel's rear surface. From this bottomed-out reference position, using a suitable tool, tightening the hex nut ¼ turn clockwise will produce approximately 10 in-lbs (1.3 N-m) of torque; tightening it 3/8 turn clockwise will produce approximately 17 in-lbs (1.9 N-m).

Check to make sure the housing's anti-rotation key is aligned with the notches on both the panel and the gasket before tightening the hex nut. Over tightening the hex nut will distort the rubber gasket and may damage the threads on both the nut and the housing, thereby compromising the installation's mechanical integrity and its ability to protect against environmental effects.

**Panel Thickness:**

When using both the factory supplied EPDM gasket and hex nut (the recommended standard installation method), the DMR20-1-TMP can be mounted in panels ranging from 0.032 in. to 0.250 in. (0.8 to 6.4mm) thick. When the gasket is not used, the panel thickness range is 0.075 in. to 0.325 in. (1.9 to 8.3mm). However, using the factory supplied hardware and tightening torque recommendations results in optimal resistance to vibration, and dust and moisture ingress.

**Panel Materials:**

Acceptable panel materials include aluminum, mild steels, plastics, FR-4 pc-board, and many other materials with a flat matte surface on both sides of the cutout. The DMR-20-x-KP tools can be used with most panel materials, except for stainless steel or other hardened metals.

DMR20-1-TMP has passed vibration testing combined with temperature cycling while mounted to the materials noted above, using the specified tightening torques. If the unit will be mounted to extremely smooth or slippery surfaces, the user is advised to test the completed

Digital Thermometer with Thermistor Probe

assembly under the environmental conditions expected in the end application.

- 5. Power Supplies, Fusing, and Wiring:** DMR20-1-TMP thermometers contain an internal, self-resettable fuse. However, the power supply wires connected to TB1 must be fused with an external, user supplied, 0.25A/300V time delay/time lag fuse, in accordance with applicable regulatory codes.

All input supply wiring must be rated for the voltages and currents they will conduct and comply with any code or application-mandated requirements pertaining to the user's specific installation. 300V, UL-rated hook-up wire suitable for the intended application is required. TB1 is to be used only for powering the meter's internal circuitry; it must not be used to supply power to external loads.

The recommended TB1 supply wire size is 18AWG to 26AWG (1.0mm<sup>2</sup> to 0.14mm<sup>2</sup>) solid or stranded copper wire. The supply wires must be

properly stripped and attached to TB1 such that their insulation is not pinched by the screw terminal. Recommended insulation strip length is 0.2 in. (5.1mm). When using stranded wire, verify that there are no loose or stray strands that could potentially cause a short circuit across the unit's supply input.

Observe correct polarity when connecting a DC power source to TB1; see the Mechanical Specifications section of this data sheet for more information. However, intermittent or continuous application of reverse-polarity voltages up to -75V will not damage the meter.

When a 24Vac supply is used to power DMR20-1-TMP, it must be derived from the secondary output of a suitably rated step-down voltage transformer. The transformer must provide the minimum level of primary-to-secondary safety isolation required for the user's intended application. As previously noted, the thermistor probe and its wire leads are not electrically isolated from the power source connected to TB1.

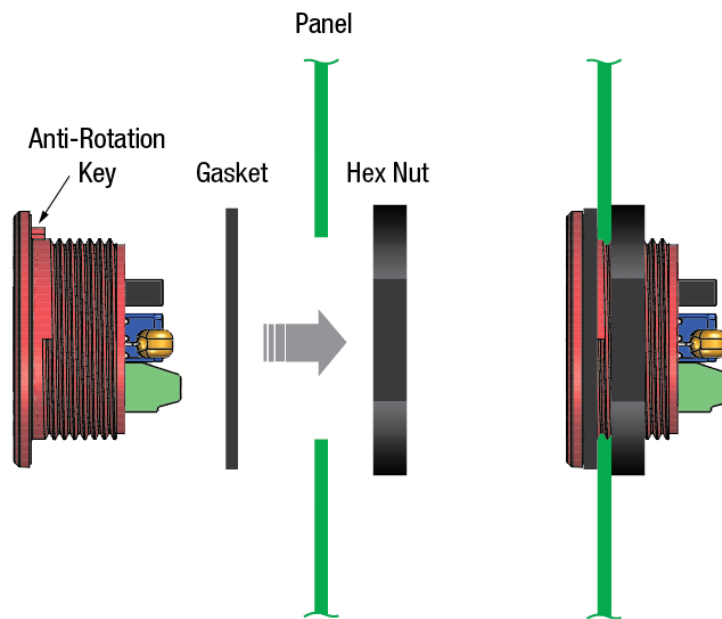

Figure 2. Panel Installation

**MECHANICAL SPECIFICATIONS**

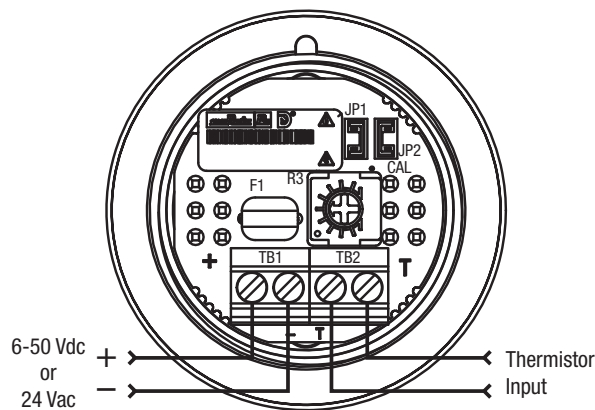
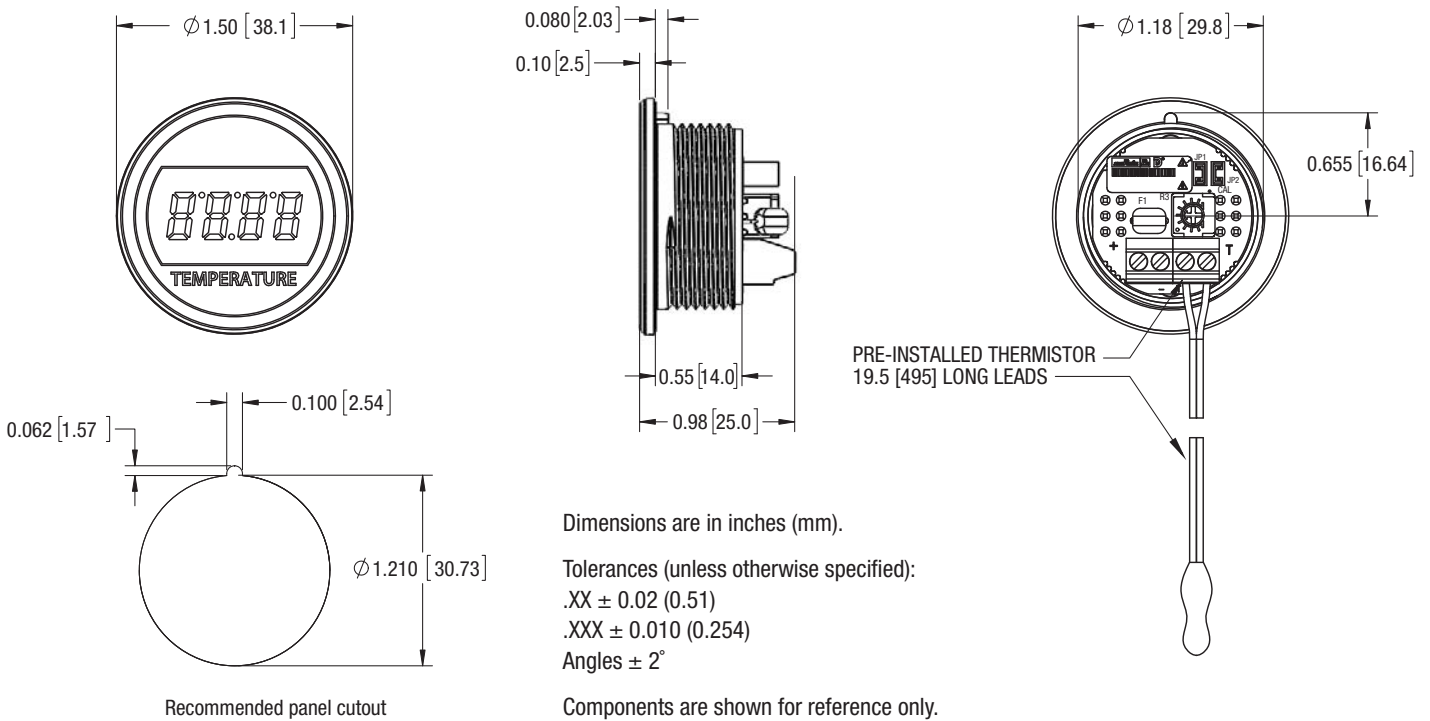

Figure 3. Input/Output Connections

3D models are available at [www.murata-ps.com/en/3d/meters.html](http://www.murata-ps.com/en/3d/meters.html)

Murata Power Solutions, Inc.  
11 Cabot Boulevard, Mansfield, MA 02048-1151 U.S.A.  
ISO 9001 and 14001 REGISTERED



**This product is subject to the following operating requirements and the Life and Safety Critical Application Sales Policy:**  
Refer to: <http://www.murata-ps.com/requirements/>

Murata Power Solutions, Inc. makes no representation that the use of its products in the circuits described herein, or the use of other technical information contained herein, will not infringe upon existing or future patent rights. The descriptions contained herein do not imply the granting of licenses to make, use, or sell equipment constructed in accordance therewith. Specifications are subject to change without notice. © 2015 Murata Power Solutions, Inc.