

PLEASE CHECK WWW.MOLEX.COM FOR LATEST PART INFORMATION

Part Number: [0522711879](#)
Status: **Active**
Overview: FFC-FPC (SMT)
Description: Easy-On™ Type FFC/FPC Connector, Right-Angle, Surface Mount, ZIF, Bottom Contact Style, 18 Circuits, High Barrier Packaging

Documents:

3D Model	Application Specification AS-52271-001 (PDF)
Drawing (PDF)	Packaging Specification SPK-52271-002 (PDF)
Product Specification PS-52271-053 (PDF)	RoHS Certificate of Compliance (PDF)

Agency Certification

CSA	LR19980
UL	E29179

General

Product Family	FFC/FPC Connectors
Series	52271
Overview	FFC-FPC (SMT)
Product Name	Easy-On™
UPC	822348148776

Physical

Circuits (Loaded)	18
Color - Resin	Natural
Contact Position	Bottom
Durability (mating cycles max)	30
Entry Angle	90° Angle
Flammability	94V-0
Mated Height	3.00mm
Material - Metal	Phosphor Bronze
Material - Plating Mating	Tin-Bismuth
Material - Plating Termination	Tin-Bismuth
Material - Resin	Nylon
Net Weight	779.432/mg
Number of Rows	1
Orientation	Right Angle
PCB Locator	No
PCB Retention	Yes
Packaging Type	Embossed Tape on Reel
Pitch - Mating Interface	1.00mm
Pitch - Termination Interface	1.00mm
Polarized to PCB	Yes
Stackable	No
Temperature Range - Operating	-40°C to +85°C
Termination Interface: Style	Surface Mount
Wire/Cable Type	FFC/FPC

Electrical

Current - Maximum per Contact	0.5A
Voltage - Maximum	50V AC (RMS)/DC

Material Info

Reference - Drawing Numbers

Application Specification	AS-52271-001
Packaging Specification	SPK-52271-002

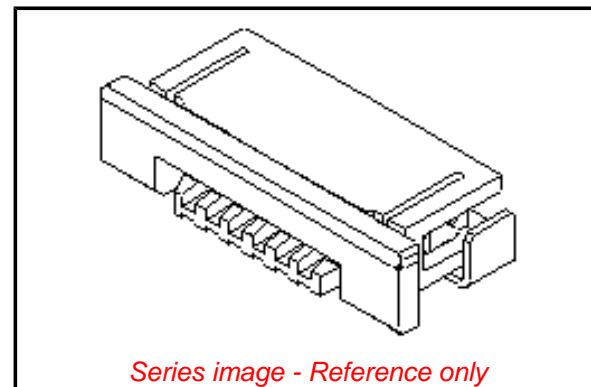

EU ELV

Not Relevant

EU RoHS

Compliant

REACH SVHC

Not Contained Per -
ED/21/2016 (20 June
2016)

Halogen-Free

Status

Not Low-Halogen

**Need more information on product
environmental compliance?**

Email productcompliance@molex.com
Please visit the [Contact Us](#) section for any
non-product compliance questions.

China ROHS

ELV

Green Image

Not Relevant

Search Parts in this Series

[52271 Series](#)

Mates With

Molex Premo-Flex FFC. Be sure to match like plating

Product Specification

PS-52271-053, RPS-52271-066, RPS-52271-067,
RPS-52271-069, RPS-52271-070, RPS-52271-072,
RPS-52271-073, RPS-52271-075, RPS-52271-080,
RPS-52271-085, RPS-52271-087, RPS-52271-091,
RPS-52271-095, RPS-52271-097, RPS-52271-102
SD-52271-036, SD-52271-037

Sales Drawing

This document was generated on 09/28/2016

PLEASE CHECK WWW.MOLEX.COM FOR LATEST PART INFORMATION