



IDEAL NETWORKS

SignalTEK NT



COPYRIGHT NOTICE

The information contained in this document is the property of IDEAL INDUSTRIES Ltd. and is supplied without liability for errors and omissions. No part of this document may be reproduced or used except as authorized by contract or other written permission from IDEAL INDUSTRIES Ltd. The copyright and all restrictions on reproduction and use apply to all media in which this information may be placed.

IDEAL INDUSTRIES Ltd. pursues a policy of continual product improvement and reserves the right to alter without notice the specification, design, price or conditions of supply of any product or service.

iPhone® and iTunes® are trademarks of Apple Inc., registered in the U.S. and other countries.

Google Play™ and Android™ are trademarks of Google, Inc.

© **IDEAL INDUSTRIES LTD. 2015**

All rights reserved

Publication ref: 156875 Issue 2

Issue 2 - 09/15

(Applies to software revision 1.0.0 onwards)

IDEAL INDUSTRIES LTD.
Stokenchurch House
Oxford Road
Stokenchurch
High Wycombe
Buckinghamshire
HP14 3SX UK

www.idealnetworks.net



CONTENTS

Introduction.....4

Care of your SignalTEK NT5

Final Disposal.....5

Safety Information.....5

 Connector Safety5

Power6

 Power Module Management.....6

 Power Module Recharging.....6

 Switching ON and OFF.....6

 Power Saving.....7

 Master Reset.....7

Handset Controls, Indicators and Ports.....8

Menu Navigation.....9

 Soft Keys.....9

Data entry.....9

Getting started10

Modes of Operation10

 Cable.....10

 Ethernet.....10

Ports.....12

Replaceable insert - RJ-45 socket12

Setup13

 Setup menu descriptions.....14

Supported SFP Transceivers.....17

Tests modes18

 Cable mode18

 Ethernet mode18

Tests - run, setup and save.....19

Tests menu description - Cable mode.....20

 Wiremap20

 Tone.....23

 Autotest23

Tests menu description - Ethernet mode24

 Cable performance.....24

 PoE.....25

 Blink25

 Ping4 and Ping626

 TRoute4 and TRoute626

 Netscan.....27

Data Performance Tests.....27

 VoIP.....28

 Web.....29

 Video29

 CCTV29

Jobs.....30

 Using the Jobs menu.....31

 Change the active Job.....31

 Managing Jobs.....32

Generating Reports.....33

Specifications - SignalTEK NT35

 Near-End Unit.....35

 Remote Unit50

Glossary, abbreviations and acronyms.....55

Introduction

SignalTEK NT comprises two hand-held units and a set of standard accessories all held in a semi-rigid case.

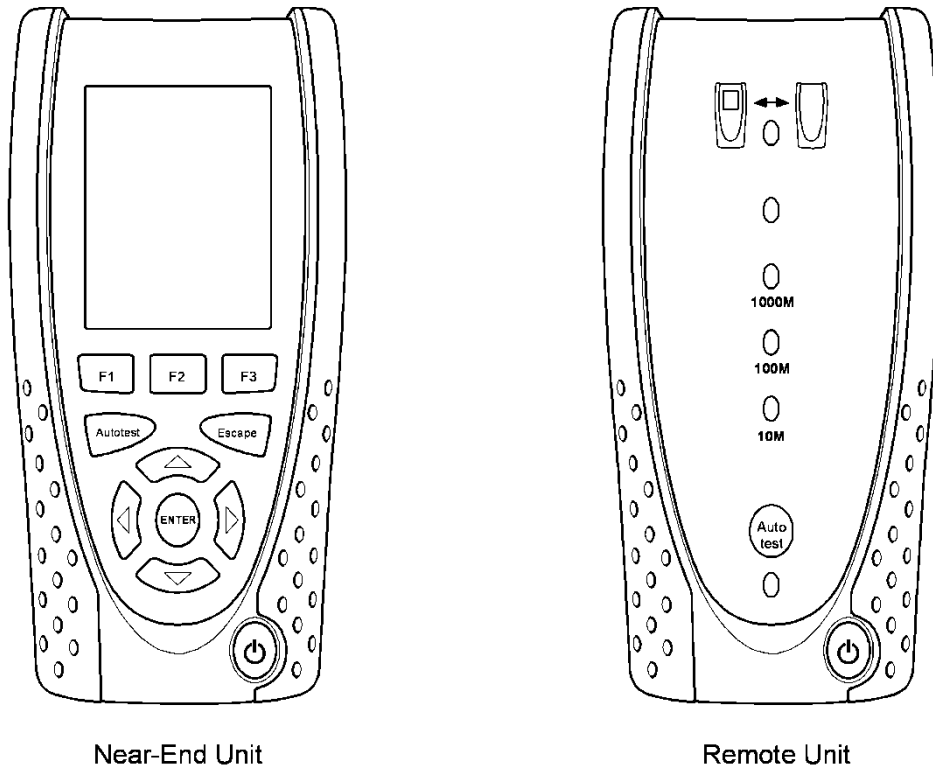

Fig 1 SignalTEK NT components

The Near-End unit is the terminal from where all tests are run and stored. The Remote Unit is a loopback terminal that enables performance testing. The Near-End Unit and Remote Unit are paired. When they are both connected to the same network, the Near-End Unit will find the Remote Unit that it is uniquely paired with, and not any other SignalTEK NT Remote Unit that may be connected to the same network.

The Near-End unit may be used as a stand-alone device for wiremap testing copper network cables. When both units are directly connected by a cable, wiremap and cable performance tests can be run. When the Near-End Unit is connected to a network, it can be used to carry out a range of IP tests. When both the Near-End and Remote Unit are connected to an active network, both IP tests and network performance tests are possible.



Care of your SignalTEK NT

Although light and portable, the SignalTEK NT units are robust and have been designed to operate in a protected outdoor working environment.

To ensure reliable operation:

Avoid very high or low temperatures - SignalTEK NT is designed to operate between 0°C and +40°C, although you should only charge the batteries between +10°C and +30°C. You can store the unit safely between -20°C and +70°C.

To avoid damage, when they are not in use we recommend that you keep both SignalTEK NT units in their carrying case.

Do not use solvents, strong detergents or abrasive materials to clean SignalTEK NT. Use only cleaning agents approved for use on ABS and polycarbonate plastics.

Final Disposal

When your SignalTEK NT has reached the end of its life you must dispose of both complete units in accordance with local environmental regulations.

Safety Information

When using SignalTEK NT, always take basic safety precautions to reduce the risk of fire, electric shock and injury to persons. These include the following:

When connecting to the line, special care must be taken as high voltages may be present on the line and there may be a danger of electrocution.

Avoid using SignalTEK NT during an electrical storm - there is a remote risk of electric shock by lightning.

Use only the mains electricity adaptor supplied with your SignalTEK NT.

CLASS 1 LASER PRODUCT. Light output from the fiber optic port can damage eyesight even though it is invisible. Never stare into open optical ports or the end of a fiber to see if light is coming out.

Connector Safety

The following connectors conform to EN60950 SELV safety status:

RJ-45 Ethernet port.

USB port.

DC inlet port.



DO NOT CONNECT ANY TELECOMMUNICATIONS NETWORK TO ANY OF THE TESTER'S PORTS

Power

SignalTEK NT can be powered from:

- A rechargeable power module,
- Directly from power connected to the DC inlet built in to the power module.

Power Module Management



The power module must be fully charged before you use it for the first time

A fully charged power module will support up to five hours of heavy, continuous use. For maximum life of the power module it is recommended to discharge it fully and then recharge it fully at least once a month. The power module is not user-serviceable. When it has reached the end of its life, please contact your local IDEAL representative for service.

Power Module Recharging

The power module can be fully recharged in three hours with the SignalTEK NT (either unit) switched ON or OFF. To recharge the power module, connect the supplied power adaptor to the DC inlet. For convenience the power module may be removed from, or left attached to, the unit for charging. The Power LED next to the DC inlet glows green to show that the battery is being charged, and flashes green to show that it is not being charged. The Near-End Unit's power module charge state is indicated at FULL, 2/3, 1/3 and EMPTY by the graphical power meter shown in the display's information bar at the top of its LCD display.

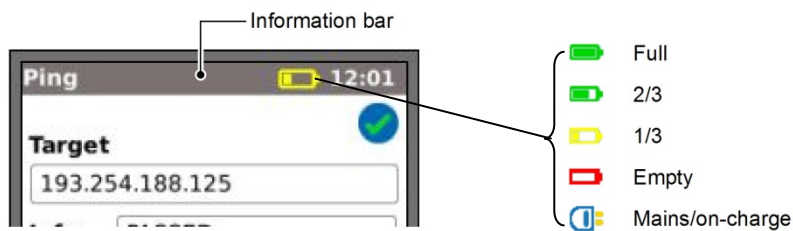

Fig 2 Power indications

The Remote Unit's power module charge state is indicated by an LED directly below the Autotest key. LED indications are:

Power LED	Status
Green	Power ON. Battery level sufficient for use
Red	Power ON. Battery charge level low but still operational
Off	Power OFF

Switching ON and OFF

To switch ON the units, press the ON/OFF button. A splash screen showing the IDEAL logo and model identity is shown on the display. The Near-End unit attempts to detect a network and the Remote Unit. The home screen is then shown on the display. SignalTEK NT is ready for use.

To switch OFF either unit, press and hold the Power button for approximately 1/2 second, a shutdown message is displayed on the screen. The currently stored setup is saved. If the unit does not switch OFF within five seconds, see *Master Reset*. Always switch OFF the unit before removing the power module.

Caution

Do NOT remove the power module when the unit is switched on.

Power Saving

Near-End Unit. Power saving preferences are selected from SETUP>SYSTEM>PREF. Auto Off can be Disabled (unit remains ON indefinitely), or set to switch the unit OFF after three, 10 or 30 minutes of inactivity. The backlight can be set to Always On, or to dim to 50% brightness after three minutes of inactivity. Note that when mains power is connected the display is always on full brightness and the unit remains ON indefinitely.

Remote Unit. The remote unit remains ON indefinitely whether on battery or mains power.

Master Reset

In the unlikely event of a system lock-up which prevents the unit from being switched OFF, it may be necessary to perform a master reset. This will not delete any stored data.

Remove the power module to access a small aperture in the SignalTEK NT (Fig 3).

Insert a paper clip into the reset hole and press the internal reset switch.



Fig 3

Replace the power module.

Handset Controls, Indicators and Ports

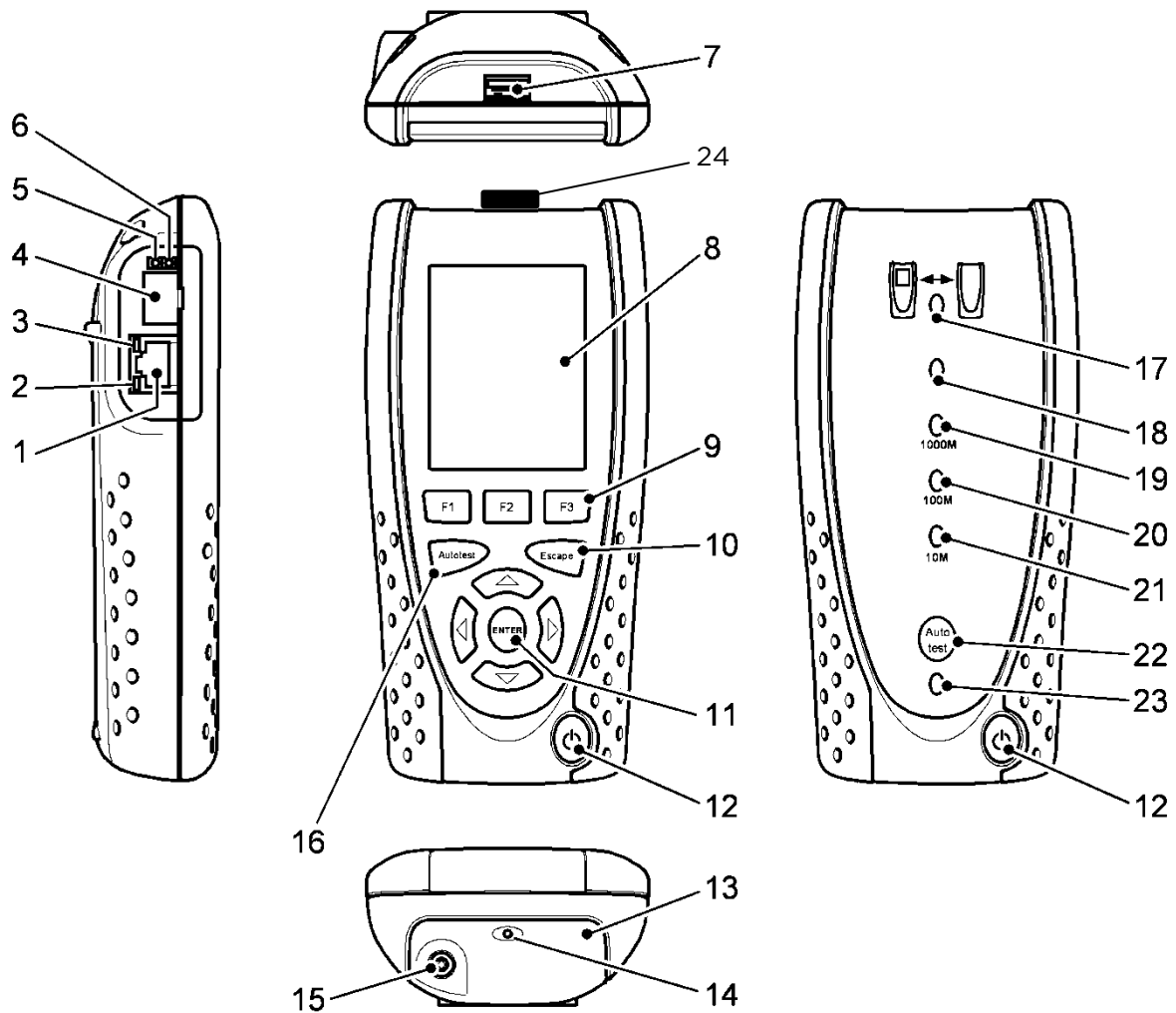

Fig 4

1	RJ 45 port	9	Function keys F1 to F3	17	Link LED
2	RJ 45 activity LED	10	Escape key	18	Status LED
3	RJ 45 link LED	11	Cursor and ENTER keys	19	1000 Mb/s line rate LED
4	Optical port (SFP)	12	ON/OFF button	20	100 Mb/s line rate LED
5	Optical activity LED	13	Power module	21	10 Mb/s line rate LED
6	Optical link LED	14	Charger LED	22	Remote Autotest button
7	USB port	15	DC in connector	23	Power LED
8	LCD color display	16	Autotest button	24	Wi-Fi Adaptor

Menu Navigation

Cursor and ENTER keys. The arrowed cursor keys are intuitively marked to move the highlighted field between all menu icons, settings fields and drop-down menus that appear on the display. ENTER selects the currently highlighted option.

Escape key. Returns to previous screen or hides the options of a drop-down menu. Note that when a value in a settings field is changed, if the Escape key is pressed *before* the soft key 'APPLY', the value will not be stored.

Autotest key. Immediately runs pre-stored range of tests. The range is easily changed using the SETUP menu. The Autotest keys on the Near-End and Remote Unit have identical function.

Function keys. F1 to F3 are to select the corresponding soft keys at the lower edge of the display.

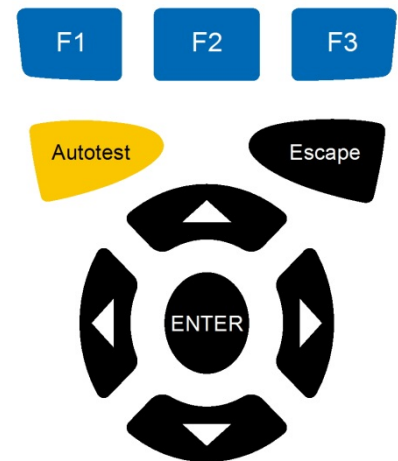

Fig 5

Soft Keys

The soft keys appear along the bottom edge of the display. Their function changes and is dependent on the screen currently shown on the display.

Data entry



Fig 6

When you navigate to and select a field that requires a value or text to be entered, such as a customer's name or a URL, a QWERTY keyboard will be shown on the display (Fig 6). All data is entered using the QWERTY keyboard. Move the key that is highlighted on the keyboard using the tester's cursor keys. ENTER selects the currently highlighted key which will now appear in the text window directly above the keyboard. Key stroke errors are corrected using the backspace key (<-). Press the UP cursor key to move the cursor into the text window for editing.

Press the QWERTY keyboard's SHIFT key to change the display from lower to upper case. Press SHIFT a second time to display symbols and punctuation characters.

When the text or value has been entered, press the soft key OK (F1). The display will return to the previous screen which is now populated with the required data. You must press the soft key APPLY to save the changes.

Getting started

Press the soft key DETECT (F1) and the Near-End Unit will determine the mode of operation dependent on the services detected. The display will show a home screen with one of four connection symbols. There are two modes of operation, Cable and Ethernet. Cable has one way of connecting, Ethernet has three.

Modes of Operation

Cable

Cable mode is used for Wiremap testing and cable route tracing using the tone generator. When the Near-End Unit is connected to a copper cable, with or without an Active Remote, press the soft key DETECT (F1) to display all options available from the Cable mode screen. When an Active Remote is connected it will be shown on screen (Fig 7) and its identification number displayed. For a full description of these options, see *Tests menu description - Cable mode*.

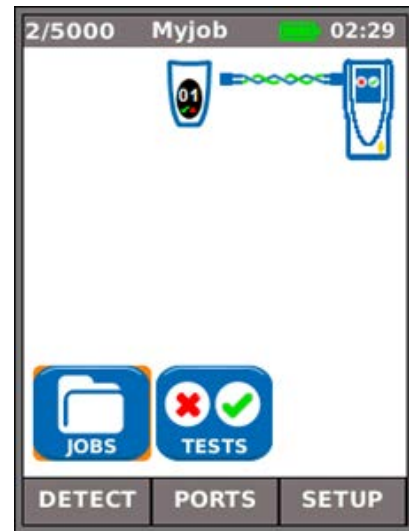

Fig 7

Ethernet

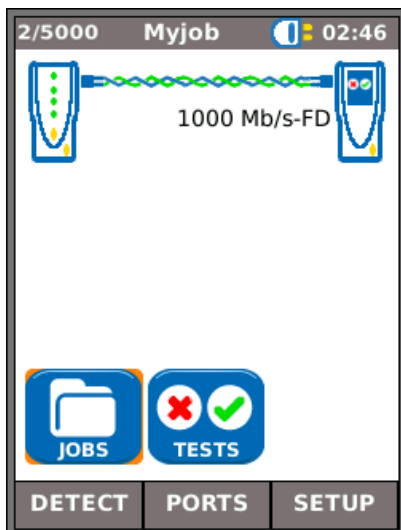

Fig 8

Ethernet mode is used for a range of IP and performance tests. There are three ways to connect in Ethernet mode:-

(1) When the Near-End Unit and Remote Unit are directly connected, with copper or fiber cable, press the soft key DETECT (F1) to detect all options available (Fig 8). In addition to wiremap tests (copper), cable performance can be tested and measured. For a full description of these options see *Tests menu description - Ethernet mode, page 24*.

(2) When the Near-End Unit is connected to an active network, using copper or fiber cable, press the soft key DETECT (F1) to display all options available (Fig 9). IP tests can be run. For a full description of these options see - *Tests menu description - Ethernet mode, page 25*.

The detected services are PoE (802.3af/at), ISDN, PBX and Unknown. The connected Port number and LLDP Power are displayed (when available.) The IPv4 and IPv6 addresses assigned to the tester are displayed (when available).

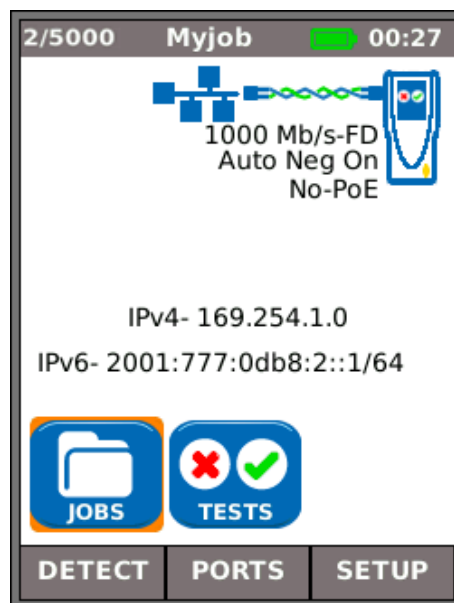

Fig 9

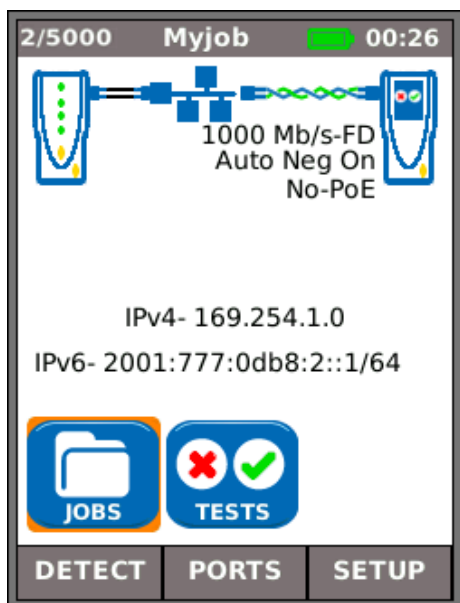

Fig 10

(3) When both the Near-End Unit and Remote Unit are connected to an active network, using copper or fiber cables, press the soft key DETECT (F1) to display all options available (Fig 10). IP tests and performance tests can be run. For a full description of these options see - *Tests menu description - Ethernet mode, page 28*.

The detected services are PoE (802.3af/at), ISDN, PBX and Unknown. The IPv4 and IPv6 addresses assigned to the tester are displayed (when available).

Ports

From the home screen press the soft key PORTS (F2), highlight the required port and press ENTER (Fig 11).

Tick the check box to always see this screen at startup.

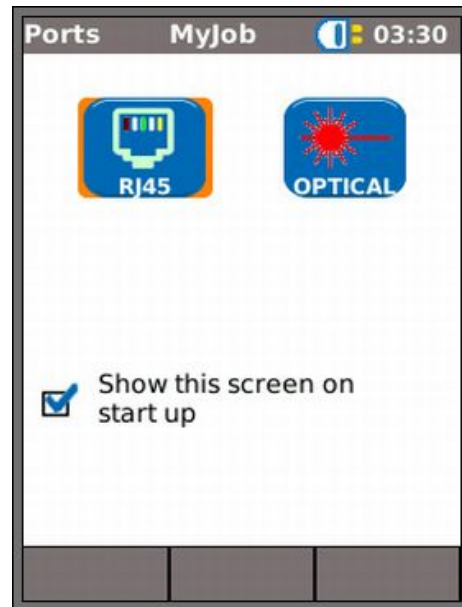

Fig 11

Replaceable insert - RJ-45 socket

To replace a damaged or worn RJ-45 socket insert proceed as follows:

Equipment required: Kit, IDEAL part number 150058 - includes Tool x1 and Replacement Insert x10.

1. Switch the SignalTEK NT off.
2. Remove cables.
3. Carefully push the tool STRAIGHT into the socket. BE CAREFUL - DO NOT MOVE THE TOOL VERTICALLY!
4. Keeping the tool STRAIGHT firmly pull the insert out from the socket.
5. Using fingers replace a new insert STRAIGHT into the socket and secure in place by firmly pushing



3.



4.

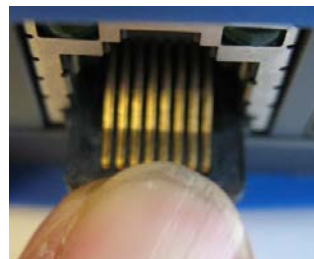

5.

Fig 12

Setup

All user-defined settings and preferences of the SignalTEK NT are set from the SETUP menu.

A description of the available settings and preferences is found on *pages 14 to 17*.

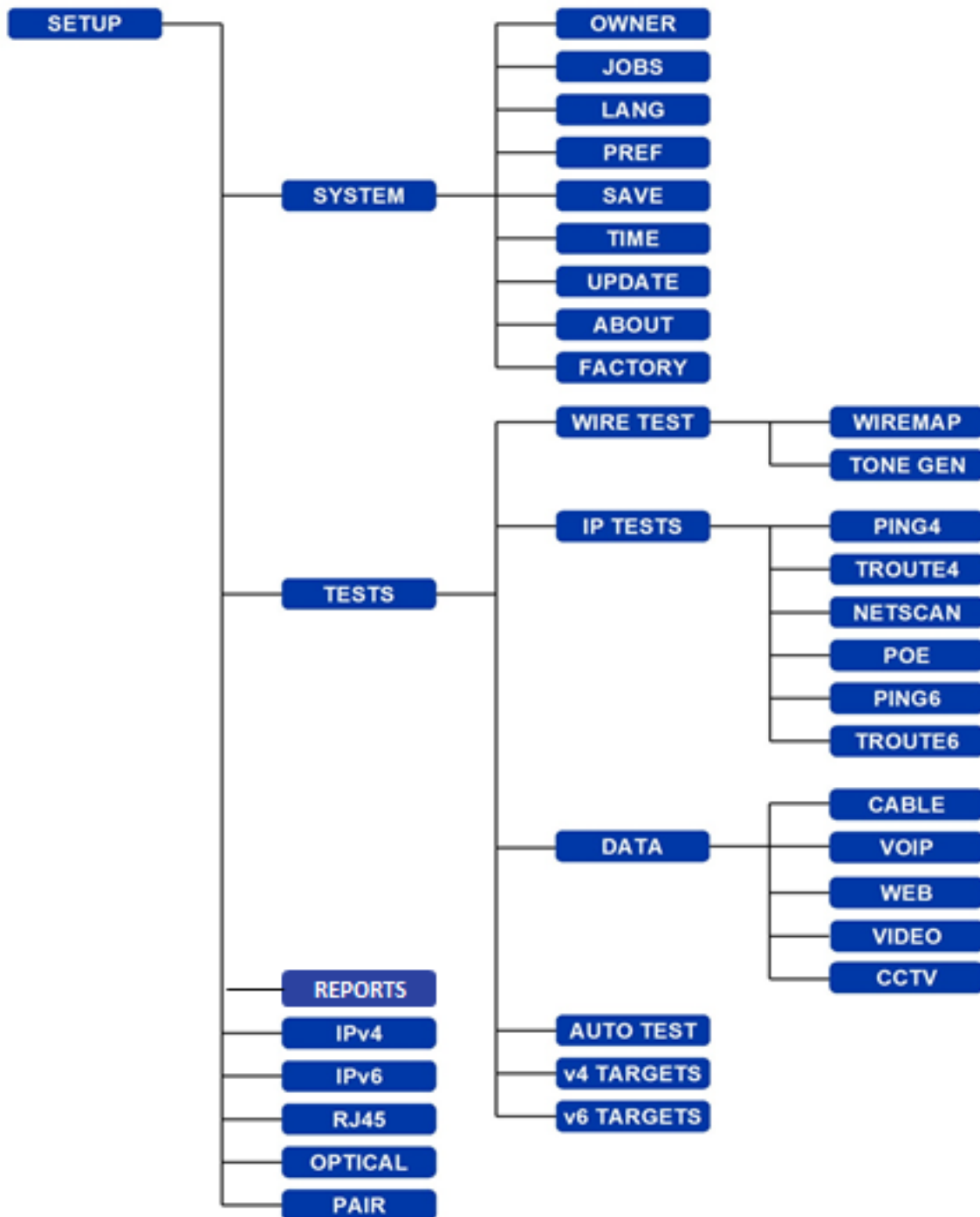

Setup menu descriptions

From the home screen, press the soft key SETUP (F3) to display the Setup menu shown in Fig 13. The settings for all tests, functions and preferences can be changed and saved from here.

Selecting any of the seven icons will produce the options that follow:

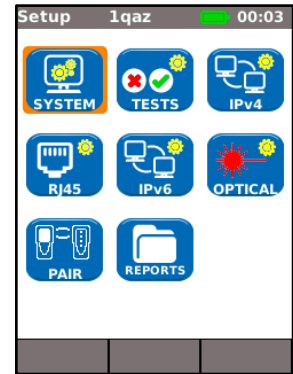

Fig 13

Highlight the System icon and press ENTER to access the settings and preferences listed below:



Enter your name or your company's name, address and phone number(s). The details stored here will appear on all reports exported via a USB key.



This option enables you to manage Jobs as follows: Create new Jobs. View, edit or delete existing Jobs. Save Jobs to a USB key. Set up Jobs preferences and result Name format. The 'Activate' icon selects the Job you require to be active. See *Jobs* for a full description.



Sets the language for the tester. The on-screen display, and the exported results and reports will appear in the selected language.



Sets the power saving options, the preferred units of length and the date and time formats.



Export or import setup information to/from a USB key. Use this function when you wish to copy setup information from one tester to another.



Sets the current date and time. Note that the date and time are recorded against test results and will appear on exported reports. The internal clock is autonomous of the power module for up to one day.



For the Near-End Unit this menu item facilitates software updates downloaded from the IDEAL website and saved to a USB key. Select the update icon and follow the on-screen instructions. To update the Remote Unit: with unit switched OFF, insert USB key and then PRESS and HOLD the AUTOTEST key while switching on the unit.

The LEDs will illuminate in sequence indicating that a software update is in progress. The unit reboots when the update is complete.



Provides model, software, hardware and firmware information.



Provides the option to return all settings to the factory default. The Near-End and Remote Unit must be paired after resetting to factory default. Refer to PAIR on *page 17*.



**A FACTORY RESET WILL REMOVE ALL STORED
DATA
AND PAIRING INFORMATION
FROM THE TESTER**



Highlight the Tests icon and press ENTER to access the settings and preferences listed below:



The two wiretests that follow are available :-



Set the cable type and color scheme to suit the cable to be tested, crossover allowed y/n, and NVP. NVP is preset at 72% but can be custom set anywhere in the range of 59 to 89% to suit the cable to be tested.



Select from three tones. This avoids confusion when a second or third tester is being used on the same installation. Choose on which pin, or pin pair, to play the tone to achieve the best results.



The six IP tests that follow are available :-



Set the target URL/Numerical address (select from up to 10 targets stored in the v4 TARGET look up table or edit the currently displayed URL), Count (Number of times to repeat the Ping - 1 to 999999), Pause (Interval between successive Pings - 10 to 5000 ms), Length (Number of bytes in Ping frame payload - 8 to 1000 bytes).



Set the target URL/Numerical address (select from up to 10 targets stored in the v4 TARGET look up table or edit the currently displayed URL), Maximum number of hops (2 to 100), Timeout (Abort timeout for any hop: 2 to 30 secs), Use a short timeout to reduce test time, or a long timeout to reach remote internet locations. Protocol (ICMP or UDP as required by your network). Select Name Lookup if supported by your network. If not required, de-select Name Lookup to reduce test time.



Select whether the Netscan is to be Local (scan within the range of the tester's own IP address) or Custom (scan within the range of the IP address configured). Set the Scan Range depending on whether a wide scan or a short test time is more important.

Scan Range	Max Number of Hosts	Test time
Class C/24	256	Short
Class C/20	4096	Medium
Class B/16	65,536	Long

IPv6 Netscan Setup - None required (Automatically set).



Select PoE or PoE Plus to suit your network. Set minimum power to be detected to suit the demand of your appliance.



IP Tests continued



Set the target URL/Numerical address (select from up to 10 targets stored in the v6 TARGET look up table or edit the currently displayed URL),
 Count (Number of times to repeat the Ping - 1 to 999999),
 Pause (Interval between successive Pings - 1 to 5 seconds),
 Length (Number of bytes in the Ping frame payload - 8 to 1000 bytes).



Set the target URL/Numerical address (select from up to 10 targets stored in the v6 TARGET look up table or edit the currently displayed URL),
 Maximum number of hops (1 to 30),
 Timeout (Abort timeout for any hop - 2 to 30 secs),
 Select Name Lookup if supported by your network. If not required, de-select Name Lookup to reduce test time.



The five performance tests that follow are available:



Tick IEEE802.3 check box to set the frame failure threshold to 0 and the test duration to 10 secs. With the tick box unchecked the frame failure threshold and duration can be set manually to suit your test. The frame size is permanently set to 1518. Frame fill is always fixed. Select the expected Line Rate depending on the cable type.



No. of Calls (Set expected number of simultaneous calls on the network - 1 to 10,000),
 Threshold (Frames) (Enter the number of errored frames acceptable - 0 to 99),
 Duration (Set test duration from 1 second up to 24 hrs).



No. of sessions (Set expected number of simultaneous sessions on the network - 1 to 500),
 Threshold (Frames) (Enter the number of errored frames acceptable - 0 to 99),
 Duration (Set test duration from 1 second up to 24 hrs).



Definition (Set to HD or SD),
 No. of Streams (Set expected number of simultaneous calls on the network - 1 to 70),
 Threshold (Frames) (Enter the number of errored frames acceptable - 0 to 99),
 Duration (Set test duration from 1 second up to 24 hrs).



Resolution (Set to VGA, 720p, 1080p, 3MP or 5MP),
 CODEC (Set to H.264 or MJPEG),
 No. of Cameras (Set the number of cameras in the system),
 Threshold (Frames) (Enter the number of errored frames acceptable - 0 to 99).



Select the tests that will run every time the Near-End or Remote Unit's Autotest button is pressed. For details of the tests available, see Fig 33.



Select this option to enter up to 10 IPv4 targets in a look up table. The targets you save here can be quickly selected when running Ping4 and TRoute4 tests.



Select this option to enter up to 10 IPv6 targets in a look up table. The targets you save here can be quickly selected when running Ping6 and TRoute6 tests.



Enable/disable IPv4 and set IP address as static or dynamic (DHCP) depending on which type your network supports. If Static is selected, enter the numerical address, Netmask, Gateway, DNS1 and DNS2.



Enable/disable IPv6 and select address type as Static, Stateless, Stateful (DCHP) depending on which type your network supports. If Static is selected, enter numerical IP address, Prefix (64 or 128), Gateway, DNS1 and DNS2.



The factory set MAC address of the tester is displayed.
The skew between the Ethernet pairs is displayed. Skew is the delay (ns) between the arrival time of the four pairs of the Gigabit Ethernet signals. It is measured relative to the first signal to arrive, so that the displayed skew is always zero for at least one pair.

NOTE

Both MAC and skew data are displayed for information only.



Provides the information that follows on the SFP connected to the Optical port:

Status - Available or Not Fitted, Vendor, Part number, Rx Power (dBm), Tx Power (dBm).

See *Supported SFP Transceivers* below.



When first supplied, the Near-End and Remote units are paired. When a different or replacement Remote Unit is used, or the Near-End Unit has been RESET to factory default settings, select PAIR from the set up menu and press the soft key PAIR (F1). When the message 'Remote detected' is shown on the display the units are paired indefinitely.



Provides the change of job reports parameters such as report format (PDF, CSV), size (Summary, Brief and Full), results content level (All, Pass, Fail) and wireless password.

See *JOBS/OPTIONS/SETUP* part on page 33 for details.

Supported SFP Transceivers

The SFP types that follow are supported. The use of other SFP types is possible but correct operation is not guaranteed.

Type	Manufacturer	Part No	Speed	Fiber type	Wavelength	Connector Type
SX	Avago	AFBR-5705PZ	1Gb/s	Multimode	850nm	LC Duplex
SX	Apac	LM28-C3S-TI-N-DD	1Gb/s	Multimode	850nm	LC Duplex
LX	Avago	AFCT-5705PZ	1Gb/s	Singlemode	1310nm	LC Duplex
LX	Apac	LS38-C3S-TC-N-DD	1Gb/s	Singlemode	1310nm	LC Duplex
ZX	Apac	LS48-C3U-TC-N-DD	1Gb/s	Singlemode	1550nm	LC Duplex

Tests modes

Testing with SignalTEK NT falls into two modes, Cable and Ethernet.

Cable mode

Cable testing comprises of wiremap tests and a tone generator.

When no network or SignalTEK NT Remote Unit is detected, the home screen information bar will read 'Cable'. When the TESTS icon is selected, the cable tests shown in the menu map at Fig 14 are available.

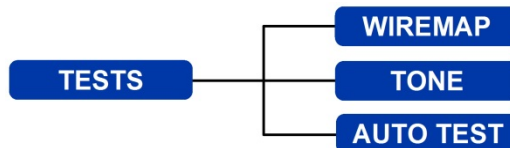

Fig 14 Tests menu map - Cable testing

Ethernet mode

Ethernet testing is divided into three categories that are dependent on the services detected by the Near-End Unit. All available tests are illustrated in the three menu maps that follow.

(1) When a SignalTEK NT Remote Unit is directly connected but no active network is detected, the home screen information bar will read 'Ethernet'. When the TESTS icon is selected, the Ethernet tests shown in the menu map at Fig 15 are available.

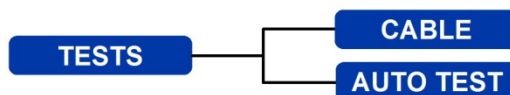

Fig 15 Tests menu map - Ethernet testing (1)

(2) When an active network is detected but no SignalTEK NT Remote Unit, the home screen information bar will read 'Ethernet' and when the TESTS icon is selected; the Ethernet tests shown at Fig 16 are available.

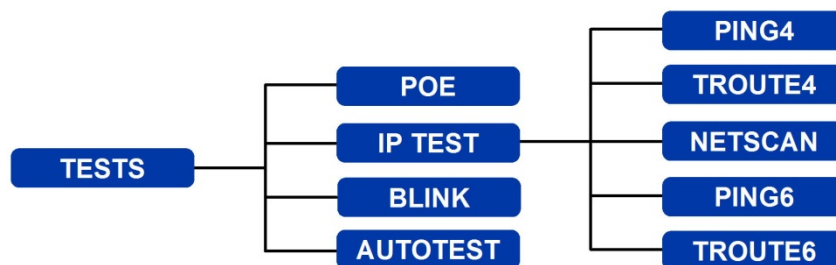

Fig 16 Tests menu map - Ethernet testing (2)

(3) When a SignalTEK NT Remote Unit is detected through an active network the information bar will read 'Ethernet'. When the TESTS icon is selected, the Ethernet tests shown at Fig 17 are available.

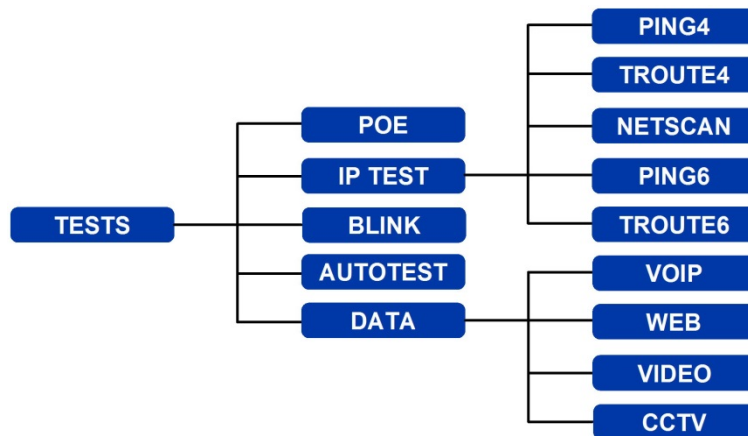

Fig 17 Test menu map - Ethernet testing (3)

Tests - run, setup and save

To select a test highlight its icon and press Enter. Each test has its own result screen. This is indicated by the test name being shown in the display's information bar. Press the soft key RUN (F1) to start the test. The test will use the setup criteria currently stored for that test. The F1 soft key changes to STOP, giving you the opportunity to abort the test.

When you want to change the setup criteria before a test is run, press the soft key SETUP (F3). The display will show a screen where all variables for the test can be changed. Press the soft key APPLY (F2) to save the changes and return to the result screen.

For all tests a symbol is displayed at the top right hand corner of the screen below the clock in the display's information bar.



Indicates test has not been run and that the tester is ready.

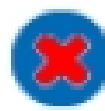

Will be displayed if the test is aborted, or when a test has been run and a fault detected or a network is unknown or unreachable.



Indicates test is in progress. This symbol is also displayed while the tester is detecting a port.



Indicates a test has been run with no faults detected.

When a test is complete the results will be displayed; the soft keys now read RUN, SAVE and SETUP. You can save the results now or press Escape to return to the Tests screen and select another test to run. The results of the previous test are not lost unless you wish to discard them by pressing the soft key RESET (F1). This arrangement gives you the choice of saving the results of either one or several tests to a single Result. To find out how Results are stored, see the description of 'Jobs' on page 30.

Press the soft key SAVE (F2) and the Save Results screen is displayed. Dropdown menus give you the choice of which job and result you would like to store the test under. The remaining storage capacity is displayed as a percentage. For a full description of the storage of test results see *Jobs*.

Tests menu description - Cable mode

When the TESTS icon from the cable mode home screen is selected, Fig 18, the available tests will be displayed, Fig 19.

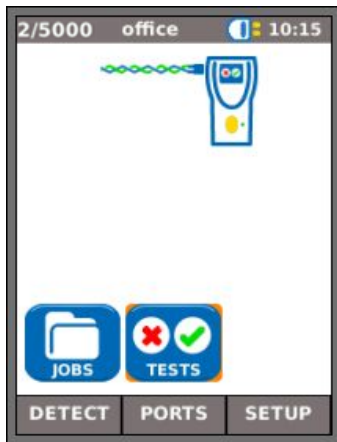

Fig 18

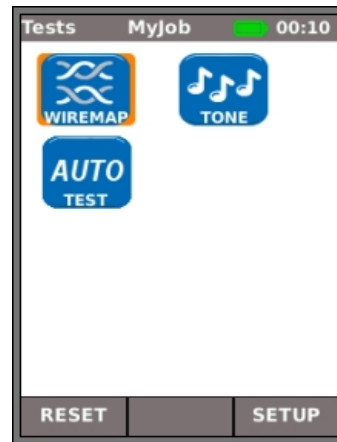

Fig 19

After any one of the three available tests from the menu is selected, the soft keys RUN and SETUP will appear:



Wiremap

When the soft key RUN (F1) is pressed a wiremap test will be run on the cable currently connected to the tester's RJ45 port. The settings used for the test will be those that have been preset via the setup menu: SETUP>TESTS>WIRETEST>WIREMAP.

After the test has been run, the display will show a graphical interpretation of the result (Fig 20) and an indication of the distance to the fault or, the length of the cable. In addition, a FAULT icon and a SAVE soft key will appear. Select the FAULT icon and the display will show a textual list of the faults detected, Fig 21.

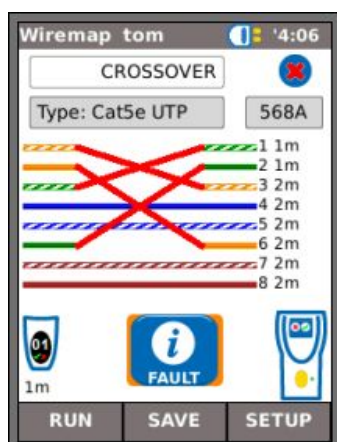

Fig 20

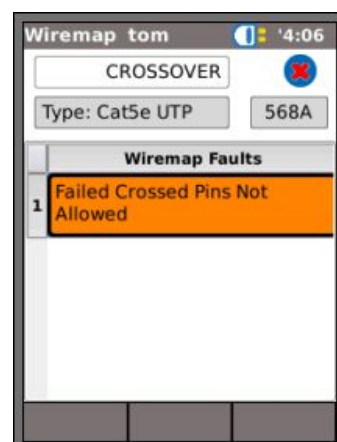

Fig 21

Note that for the example of a Wiremap test shown above; if the option 'XOver Allowed' had been checked in the Wiremap SETUP options, the results would be displayed as shown in Fig 22 and Fig 23.

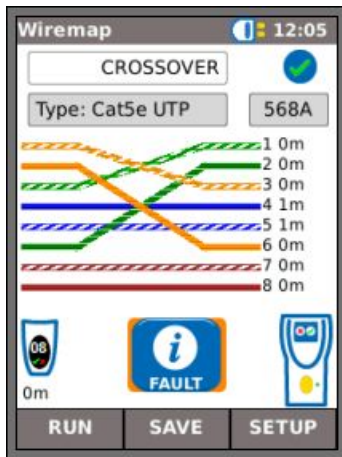

Fig 22



Fig 23

The wiremap tests may be run with no termination - open, or with an Active Remote termination. When connected, an image of an Active Remote will be shown on the display and its type identified. After a test has been run, the length of the cable is displayed (range up to 100m (330ft)).

With an open termination the possible faults detected are:

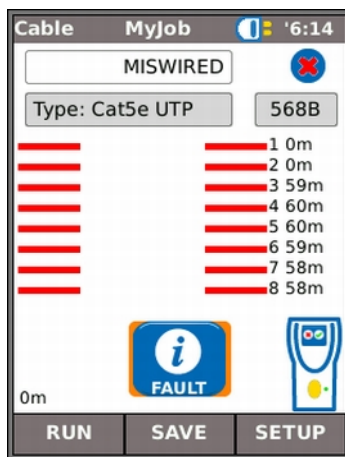

Fig 24 Open circuit by pair

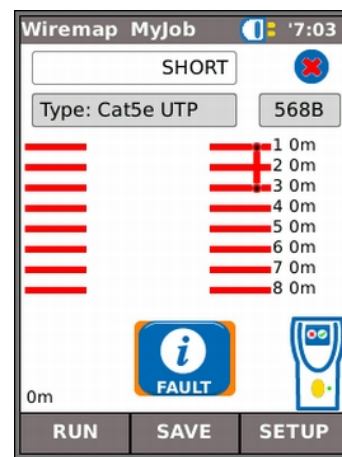

Fig 25 Short circuit by pin

With an Active Remote or a SignalTEK NT Remote Unit termination the possible faults detected are:

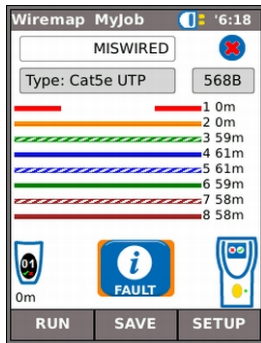

Fig 26 Open circuit by pin

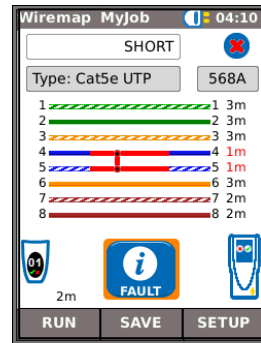

Fig 27 Short circuit by pin

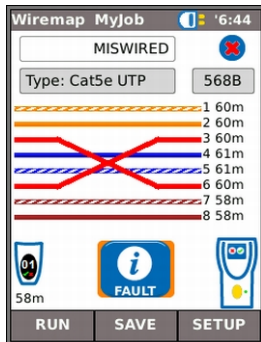

Fig 28 Crossed pairs

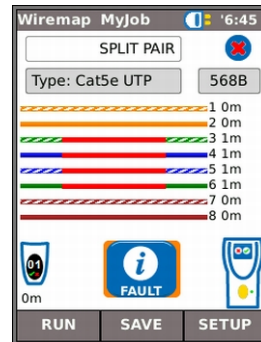

Fig 29 Split pairs

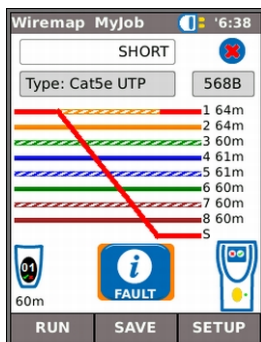

Fig 30 Bridged shorts

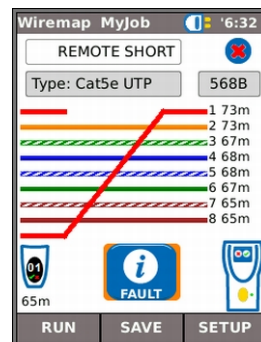

Fig 31 Remote shorts

As with the result of the Crossover fault shown in Fig 20 and Fig 21, all wiremap test results are displayed as a graphic that includes the FAULT icon. When the icon is selected, the faults are presented as a list.

The indications that follow appear on the Active Remote device:

Flashing green LED - Test Passed.

Flashing red LED - Test Failed.

Amber LED - DC voltage greater than 12 Volts detected - cannot perform test.



Tone



SignalTEK NT can act as a tone generator (Fig 32). Together with a compatible tone probe, the route of a cable can be traced. A choice of three tones can be selected. To achieve the best result, the tone may be played over one of eight pins relative to the other seven, or over one of four pairs. The tone is started and stopped with the F1 soft key which displays as RUN or STOP accordingly.

Press the soft key SETUP (F3) to change the tone and the pin, or pin pair, that the tone is played on. Press the soft key APPLY (F2) for your changes to take effect.

Fig 32



Autotest

SignalTEK NT can be set up to run a predefined range of tests when the yellow Autotest button is pressed on either the Near-End or Remote Unit. The range of tests is set from SETUP>TESTS>AUTOTEST by ticking the check boxes next to your choice, Fig 33. Press the soft key APPLY (F2) for your changes to take effect.

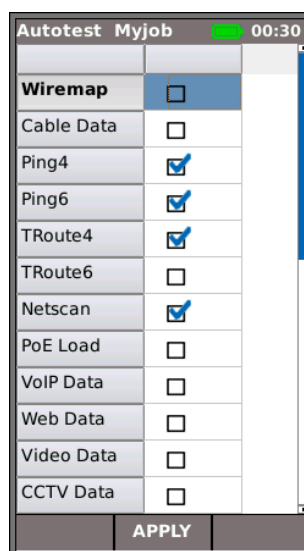

Fig 33

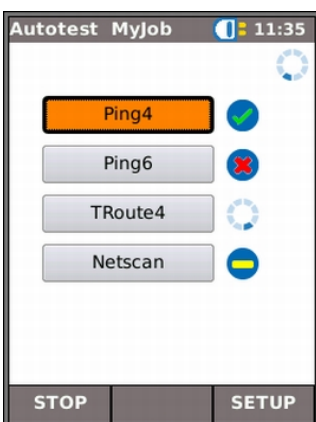

Fig 34

When an Autotest is run, Fig 34, the display lists the tests that are applicable to the current mode from the list that you selected at Setup and shows the status of each. After the Autotest is complete, or has been stopped, each individual test can be selected and its detailed results displayed.

In Cable mode, Autotest is limited to Wiremap.

Tests menu description - Ethernet mode

When a SignalTEK NT Remote Unit is directly connected but no active network is detected, select the TESTS icon from the home screen (Fig 35) to view the tests available, Fig 36.

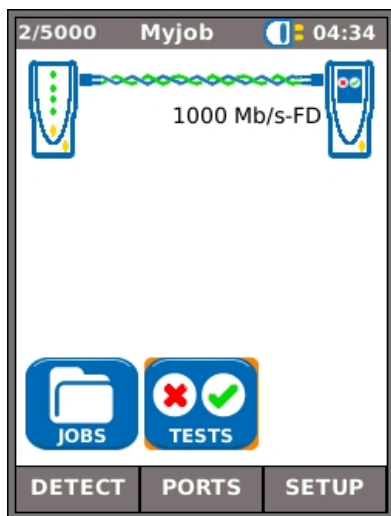

Fig 35

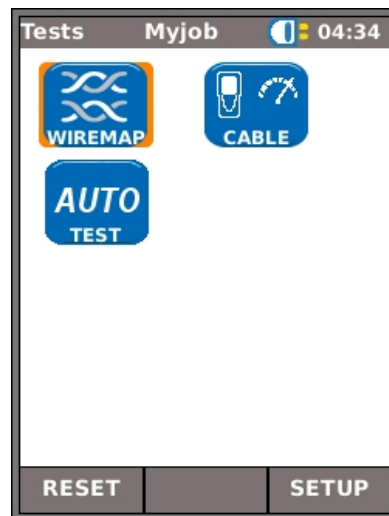

Fig 36

After any one of the three available tests is selected from the menu, the soft keys RUN and SETUP will appear:



Wiremap and Autotest are described in *Tests menu description - Cable mode*. When Wiremap is run in Ethernet mode, the only difference is that the cable to be tested is not connected to an Active Remote but to either the Remote Unit or an active network port.



Cable performance

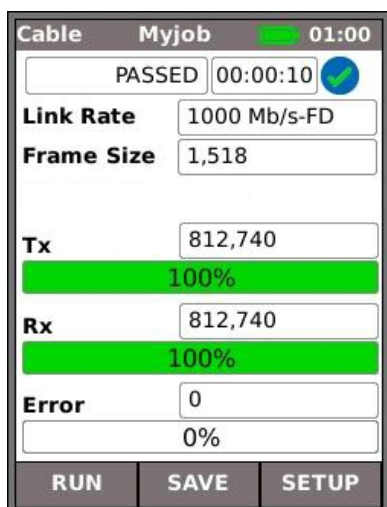

Fig 37

When a cable performance test is run, back-to-back frames are transmitted to the Remote Unit which loops them back to the Near-End Unit where they are checked and counted.

Fig 37 shows the result screen of a successful cable test. **Frame Size**, which is fixed, is stated for information. **Tx** states the number of frames transmitted, the associated green indicator bar confirms that 100% of the frames were sent. As the frame size (and fill) is fixed, the number of frames transmitted is dependent on the duration of the test only. **Rx** states the number of frames received, the green indicator bar confirms that 100% of the transmitted frames were received. As all transmitted frames were received, **Error** states 0 and its associated indicator bar remains uncolored and shows 0%. When there is a discrepancy between the number of transmitted and received frames, **Error** states the number of errored frames and the indicator bar is partly colored red proportional to the number of errored frames. However, the cable will still pass the test provided the Frame Threshold is not exceeded and the Line Rate is as expected. (See Setup page 16).

When an active network is detected but no SignalTEK NT Remote Unit, select the TESTS icon from the home screen (Fig 38) and the Tests screen (Fig 39) is displayed. In addition to Autotest, (described in *Tests menu description - Cable mode*) POE and Blink tests can be run from here. Select the IP TEST icon to reach the IP tests Ping, Trace route and Netscan (Fig 40).



Fig 38



Fig 39

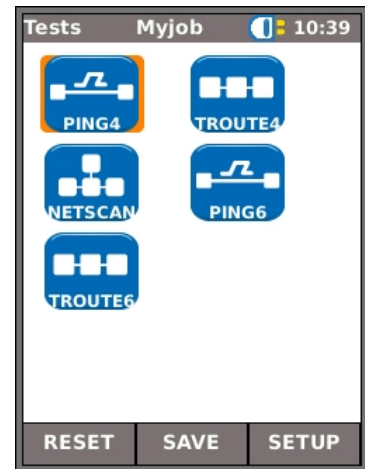

Fig 40



PoE

When the Near-End Unit is connected to a port it automatically detects PoE voltage (when present). In addition, running a PoE test will apply a resistive load and measure the power available at the connected port. SignalTEK NT identifies which pairs are carrying power, and displays the voltage (V), current (mA) and power (W). The PoE test result screen at Fig 41 shows that pair one and two, and pair three and six are carrying 11 Watts. The port tested is capable of powering devices that require upto 11 Watts.

The test is PASSED because the power available is \geq the minimum power value entered at set up.

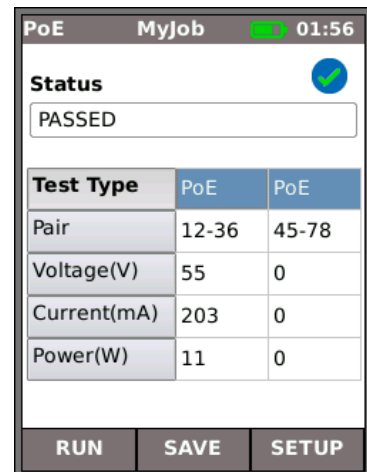

Fig 41



Blink

A Hub Blink test forces the connected port of a network device to blink. SignalTEK NT also changes the speed and therefore LED color (on supporting devices) making it easier to identify the correct port. Select the BLINK icon from the Tests screen, the test is started and stopped with the soft key F1 which displays as RUN or STOP accordingly.



Ping4 and Ping6

Ping will test the availability and measure the response times of devices and URLs. The results of a successful test, both in progress and passed are shown in Fig 42. The ranges of possible results are listed next to the figure.



- Info: READY, IN PROGRESS, PASSED, NO RESPONSE, UNKNOWN HOST.
- Tx: Count of transmitted ping frames: 1 to 999999.
- Rx: Count of successfully received Ping responses: 1 to 999999.
- Delay: Round trip delay in ms between transmitting Ping and receiving response. Displayed as Minimum, Average and Maximum.

Fig 42



TRoute4 and TRoute6

Trace Route will display the route and measure transit delays of frames across an IP network.

Press the soft key SETUP (F3) to enter the target or select one from the v4 or v6 TARGET look-up table, and to view or amend the test settings.

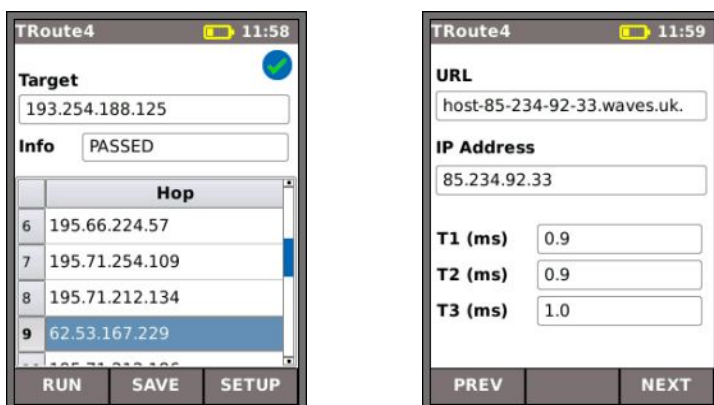

Select an individual hop to view its statistics.

The soft keys PREV (F1) and NEXT (F3) and are used to navigate between individual hops.

Each hop is traced three times. The time recorded during each trace is displayed in ms as T1, T2 and T3.

Fig 43



Netscan

Netscan will report the number of IPv4 hosts and IPv6 hosts detected within the scan range. Press the soft key SETUP (F3) to adjust the scan settings if required.

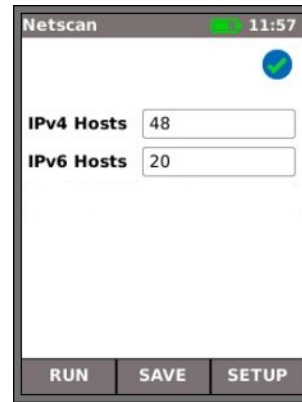

Fig 44

Data Performance Tests

One of the most important functions of SignalTEK NT is its ability to make data performance tests of cables and active networks. These performance tests are designed to test the system by sending Ethernet traffic through it, looping it back and checking it for errors. You can choose whether to test according to the IEEE 802.3 standard for Gigabit Ethernet, which requires that 10 seconds of full-rate traffic is transmitted through the system without errors, or to set your own traffic rate and pass/fail limit.

Each of the performance tests operates on the principle illustrated in Fig 45:

1. Frames transmitted to Remote Unit at calculated Frame Rate for specified duration
2. Frames looped back by Remote Unit,
3. Received frames checked and counted.

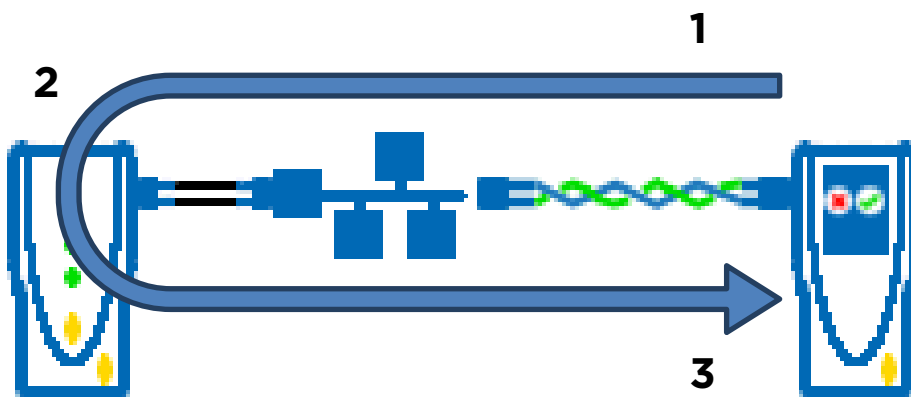

Fig 45



When a SignalTEK NT Remote Unit is detected through an active network, select the TESTS icon from the home screen (Fig 46) to display the Tests screen (Fig 47). From the Tests screen select the DATA icon to show the Performance Tests screen (Fig 48).

Before a Performance test is run, the warning and dialogue that follow are displayed:

**This test will generate traffic loading which may interfere with other network users
CONTINUE? YES/NO**

Select YES to continue with the test and not display the warning again until the next power cycle. Select NO to not continue with test and display the warning again before another test is run.

Performance tests are as follows:

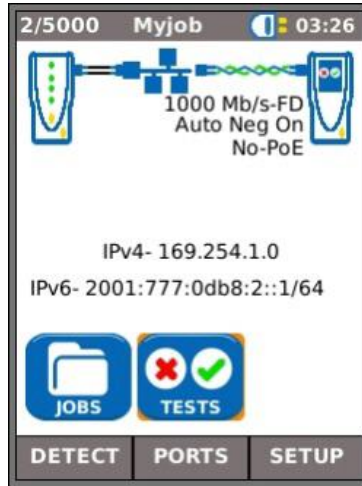

Fig 46

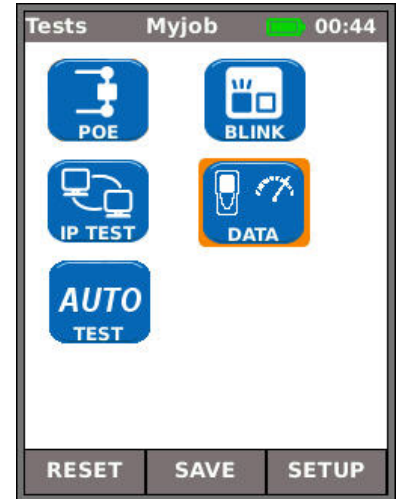

Fig 47

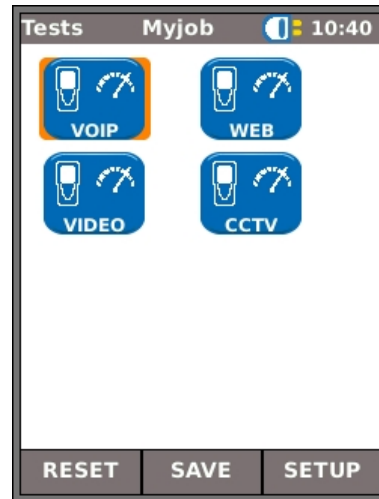

Fig 48 Performance Tests



VoIP

Fig 49 shows the result screen of a successful VoIP test. **Frame Size** and **Frame Fill** are fixed, and stated for reference only. The Information rate, **IR (Mb/s)**, is variable and dependent on the number of calls you have entered at set up. **Tx** states the number of frames transmitted, the green indicator bar confirms that 100% of the frames were sent. **Rx** states the number of frames received, the green indicator bar confirms that 100% of the transmitted frames were received. As all transmitted frames were received, **Error** states 0 and its associated indicator bar remains uncolored and shows 0%. Because the number of errors does not exceed the limit set in SETUP, the test result is PASSED.

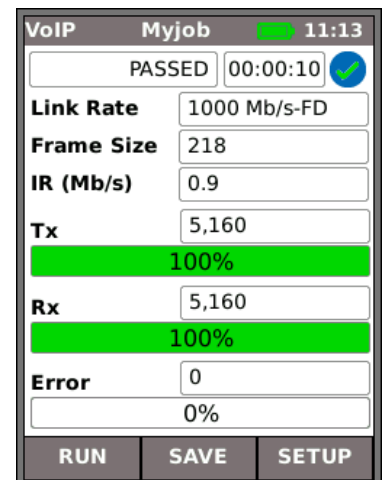

Fig 49



Web

Fig 50 shows the result screen of a successful Web test. **Frame Size** and **Frame Fill** are fixed, and stated for reference only. The Information rate, **IR (Mb/s)**, is variable and dependent on the number of sessions you have entered at set up. **Tx** states the number of frames transmitted, the green indicator bar confirms that 100% of the frames were sent. **Rx** states the number of frames received, the green indicator bar confirms that 100% of the transmitted frames were received. As all transmitted frames were received, **Error** states 0 and its associated indicator bar remains uncolored and shows 0%. Because the number of errors does not exceed the limit set in SETUP, the test result is PASSED.

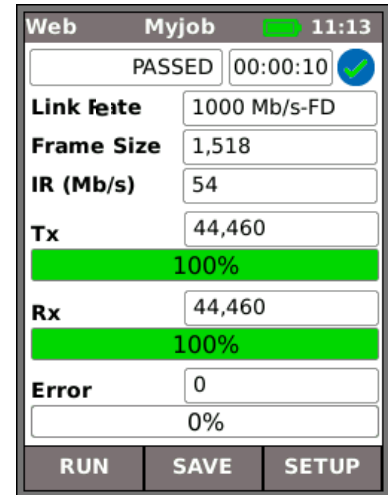

Fig 50



Video

Fig 51 shows the result screen of a successful Video test. **Frame Size** and **Frame Fill** are fixed, and stated for reference only. The Information rate, **IR (Mb/s)**, is variable and dependent on the number of streams entered and the definition (SD- Standard Definition / HD - High definition) chosen at set up. **Tx** states the number of frames transmitted, the green indicator bar confirms that 100% of the frames were sent. **Rx** states the number of frames received, the green indicator bar confirms that 100% of the transmitted frames were received. As all transmitted frames were received, **Error** states 0 and its associated indicator bar remains uncolored and shows 0%. Because the number of errors does not exceed the limit set in SETUP, the test result is PASSED.

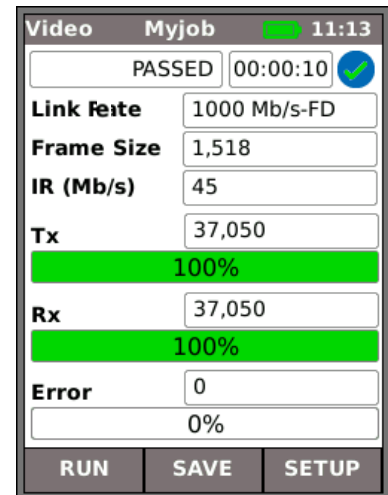

Fig 51



CCTV

Fig 52 shows a CCTV performance test in progress. **Frame Size** and **Frame Fill** are fixed, and stated for reference only. The Information rate, **IR (Mb/s)**, is variable and dependent on the Resolution (VGA / 720p / 1080p / 3MP / 5Mp), CODEC (H.264 / MJPEG) and number of cameras chosen at set up. **Tx** shows that, so far, 72,371 frames have been transmitted which is 92% of the total frames required to be sent in this test. **Rx** shows that only 62,405 of the transmitted frames have been received (79% of the total sent so far). **Error** shows the number of errored (unreturned) frames (Approx. 12%).

When the number of errored frames is \geq the Limit (Frames) that you entered at set up, the test is failed.

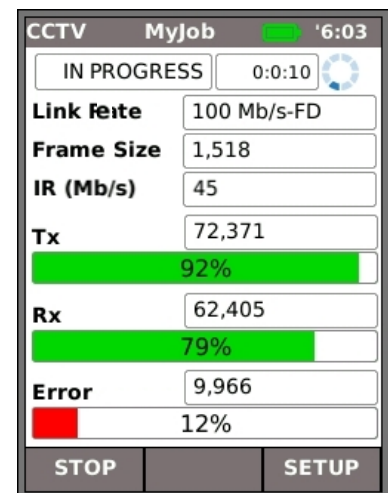

Fig 52

Jobs

SignalTEK NT provides a system that enables the storage and organization of test results and statistics. Test results can be made into reports and can be exported via a USB key or downloaded by a Wi-Fi connected smartphone.

The two elements of this storage and organization system are Jobs and Results. A Job is a named repository for a collection of Results. A Result is a group of test results. It may contain the saved results of one or several tests. Therefore, a Job may be understood as a folder, a Result as the file(s) held within that folder. SignalTEK NT can store up to 5000 results divided among up to 50 Jobs.

At any time, one Job is always 'active'. Any existing Job can be activated, at any time, via the menu on the Jobs Options screen. The currently active Job is indicated in the display's information bar.

Test results are saved by pressing the soft key SAVE (F2). The Save Result screen is displayed. From here you may choose which Job to save the test(s) to and the prefix and serial number of the Result. If you do not choose, SignalTEK NT defaults to the active Job and assigns the next serial number.

The structure in which Jobs, Results and test results are stored is shown in Fig 53.

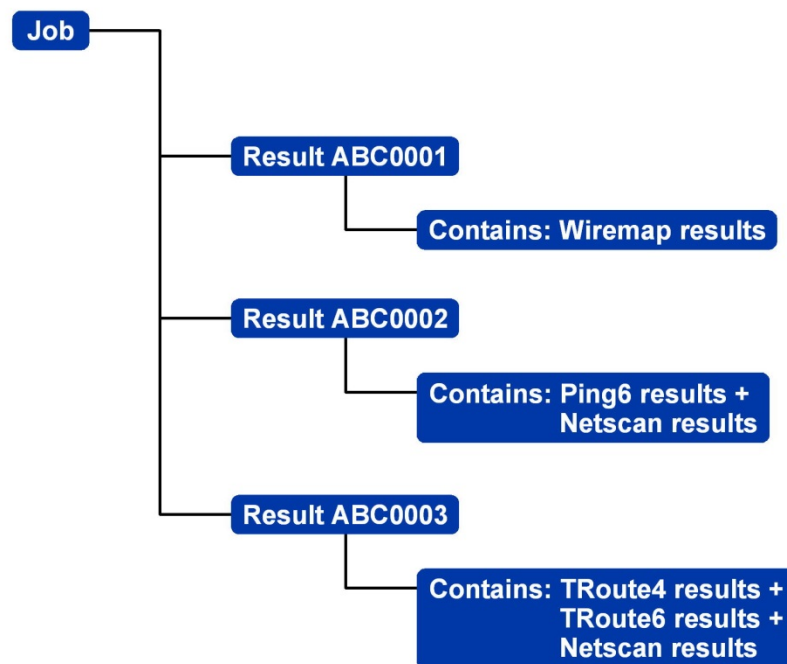

Fig 53 Example of Job storage structure

When creating a new Job, you can store:

A Job name.

General information about the cable, shelf, port etc. This information will appear on reports that are compiled from exported test results.

Using the Jobs menu

From the home screen select the JOBS icon. The display will show the Job List screen, Fig 54. The Job List screen lists all currently stored Jobs. The column 'Tests' indicates the number of Results saved to each Job. The column 'Pass %' indicates the percentage of the total number of tests in all Results allocated to a Job that have passed.

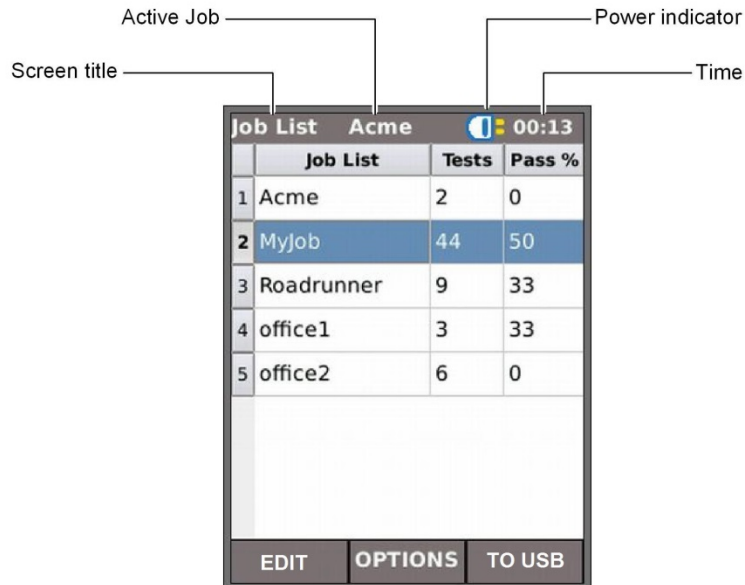

Fig 54 Job List screen

Change the active Job

In the example of a Job List screen shown at Fig 54, the active Job is 'Acme' as indicated on the display's information bar. To change the active Job, scroll to the Job required (e.g. My Job) and press the soft key OPTIONS (F2); the display will show the Options screen, Fig 55. Highlight the ACTIVATE icon and press ENTER.

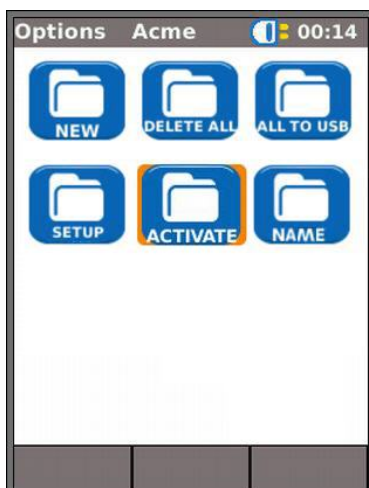

Fig 55 Options screen

The display will show a dialogue stating:

'MyJob is set as current job'

To change the active Job List from Acme to MyJob Press ENTER to confirm.

The display returns to the Job List screen, and the new active Job is now shown in the information bar.

Managing Jobs

Select one of the icons from the Job Options screen to manage Jobs as follows:



Create a new Job. Data entry fields are:

Job. Enter the title of the new Job. For example, your customer's name.

8 Information fields that can be used to record details about the Job. When a new Job is created it automatically inherits the details from the previous new Job and becomes the Active Job.



Delete all Jobs and all associated Results. When DELETE ALL is selected, the dialogue 'Are you sure you want to delete?' will appear.



ONCE DELETED, JOBS CANNOT BE RESTORED



Selects the Job to be currently active. All test results are saved to the active Job. Full details of this function are described on *page 31*.



Provides settings for user preferences for the generated reports:

- Format - PDF (useful for presentation to clients) and/or CSV (useful for incorporation into databases).
- Size - SUMMARY (a list showing test results with one line per test), BRIEF (a single page per test) or FULL (full details on multiple pages per test).
- Results - ALL results, only PASS results or only FAIL results.
- SSID - Default IDEALS-XXXXX is set for user
- Password - required for downloading to a smartphone. (The default password following Factory Reset is *ideal001606*).



Exports all Jobs to USB. Information on how to generate reports is detailed below.

To rename an existing test in a particular Job

Highlight the test and press RENAME (F1)

Press ENTER to edit the test name, then OK

To insert your own logo at the top of the reports

- Create a file *logo.png* (max dimensions 768 x 512 pixels) on a USB key
- Insert the USB key
- In SETUP/SYSTEM/OWNER, press LOGO (F1)

Generating Reports

1. Reports can be generated and exported to a USB key.

To generate a report to USB:

Insert a USB key into the SignalTEK NT USB port.

From the home screen select the JOBS icon. The display will show the Job List screen.

- Scroll down to select the required Job
- To generate a report for a single result, press ENTER to display the Results list, select the required result, press ENTER, then TO USB (F3).
- To generate a report for a single Job select the required Job then press TO USB (F3).
- To generate a report for all Jobs, press OPTIONS (F2) then select ALL TO USB.

The dialogue 'Result saved to USB' appears. Reports are now saved on the USB key in the selected format(s).

2. Reports can be generated and downloaded to a smartphone (only when no tests are running).

To enable Wi-Fi for results transfer:

- Insert Wi-Fi dongle into the SignalTEK NT USB port.
- From the home screen select the JOBS icon.
- The display will show the Job List screen. Wi-Fi connectivity is indicated by the top bar on the SignalTEK NT screen changing from grey to blue with wireless symbol toggled with battery symbol:

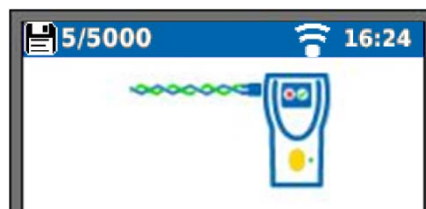

Now the SignalTEK NT is ready for results transfer wirelessly.

Note

To minimise battery consumption the Wi-Fi connectivity is enabled for 5 minutes following power up and whenever the user is in the JOB screen.

To download results to an Android™ smartphone:

- Download and open IDEAL AnyWARE™ App from the Google Play™ Store.
- Search and connect to SignalTEK NT. The SSID will be of the form "IDEALS-XXXXXX". This can be viewed on the SignalTEK NT under the SETUP | REPORTS screen.
- You will be prompted for the SignalTEK NT Wi-Fi password if it has been changed from the default value.
- Once connected the App will display list of JOBS on the SignalTEK NT. These can be selected and downloaded to the smartphone.



- Once results are on the smartphone they can then be transferred using email or other share mechanisms.

To download results to an iPhone®:

- Download and open IDEAL AnyWARE™ App from iTunes®.
- Search and connect to SignalTEK NT. The SSID will be of the form "IDEALS-XXXXXX". This can be viewed on the SignalTEK NT under the SETUP | REPORTS screen.
- You will be prompted for the SignalTEK NT Wi-Fi password if it has been changed from the default value.
- Once connected the App will display list of JOBs on the SignalTEK NT. These can be selected and downloaded to the smartphone.
- Once results are on the iPhone® they can then be transferred using email or other share mechanisms.

Apple is a trademark of Apple Inc., registered in the U.S. and other countries.

Android is a trademark of Google Inc.



Specifications - SignalTEK NT

Near-End Unit

Connectors

Test Ports

RJ45

Used for - Cable Test (With a companion Remote Unit)
- Network Test (Connected to an active network)

Connector type - Samtec Lifejack with user-replaceable contacts

Insertion Cycles - 500 min

Location - Left hand side

Optical

Used for - Cable Test (With a companion Remote Unit)
- Network Test (Connected to an active network)

Connector type - SFP socket

Location - Left hand side

System Ports

USB

Used for - Software Update
- Results transfer to memory key or via Wi-Fi adaptor

Class - Host

Connector type - A

USB type - 1.1

Location - Top

Power

Used for - Battery charging
- Mains powering via adaptor

Connector type - 2.5mm pin power jack

Polarity - Centre pin positive

Voltage - 12v

Current - 2 amps

Location - Bottom of power module

Controls

ON/OFF

Push button

Used for - Power ON/OFF

Location - Front

Function Keys

F1 to F3

Used for - Screen-defined functions

Location - Front

Navigation Keys

Cursor and ENTER

Used for - User interface navigation

Location - Front



Controls (continued)

Navigation Keys

Escape

Used for - Return to previous menu

Location - Front

Autotest

Used for - Launch of automatic test sequence

Location - Front

Reset

Push button

Used for - Escape from exceptional lockup condition

Location - Accessible through hole inside battery compartment using paper clip

Displays

Screen

LCD

Used for - Display of setup functions and results

Location - Front

Size - 2.8 inch diagonal

Type - QVGA Color

Pixels - 240 x 320

LEDs

Charger LED

Used for - Indication of charging status...

Green - Battery is charging

Off (with charger connected) - Battery is charging

Green flashing - Battery is not being charged

Color - Green

Location - Bottom of Power module

RJ45 Link LED

Use - ON indicates link UP

Location - Adjacent to RJ45 socket, nearest top of tester

Color - Green

RJ45 Activity LED

Use - Flashing indicates link activity

Location - Adjacent to RJ45 socket, nearest bottom of tester

Color - Green

Optical Link LED

Use - ON indicates Optical link UP

Location - Adjacent to SFP socket, nearest front of tester

Color - Green

Optical Activity LED

Use - Flashing indicates Optical link activity

Location - Adjacent to SFP socket, nearest back of tester

Color - Green



Ports

RJ45

Fixed Setup

Speed - Auto negotiated
Duplex - Auto negotiated
MAC - Factory set

Tests

Automatic mode selection depending on detection of Network / Remote Unit:

No-Link	(No network or Remote Unit detected)
Link	(Active network detected but no Remote Unit)
Link-Remote	(Remote Unit detected through a network device)
Remote	(Remote Unit detected but no network)
Active Remote	(Active remote #1 - #12 detected)

Link Mode Tests (Active network detected but no Remote Unit)

- IPv4 Ping
- IPv6 Ping
- Traceroute v4
- Traceroute v6
- Nmap
- PoE / PoE+ Load
- Hub Blink
- Auto
 - IPv4 Ping
 - IPv6 Ping
 - Traceroute v4
 - Traceroute v6
 - Nmap
 - PoE / PoE+ Load

Remote Mode Tests (Remote Unit detected but no network)

- Double-ended Wiremap
- Cable Performance
- Auto

Link-Remote Mode Tests (Remote Unit detected through a network device)

- VoIP Performance
- Web Performance
- Video Performance
- CCTV Performance
- IPv4 Ping
- IPv6 Ping
- Traceroute v4
- Traceroute v6
- Nmap
- PoE / PoE+ Load
- Hub Blink



RJ45

Tests

- Auto
 - VoIP Performance
 - Web Performance
 - Video Performance
 - CCTV Performance
 - IPv4 Ping
 - IPv6 Ping
 - Traceroute v4
 - Traceroute v6
 - Netscan
 - PoE / PoE+ Load

Active Remote Mode Tests (Active Remote #1 - #12 detected)

- Double-ended Wiremap
- Tone Generator
- Auto
 - Double-ended Wiremap

No-Link Mode Tests (No network or Remote Unit detected)

- Single-ended Wiremap
- Tone Generator
- Auto

Service Detection

Detected Services - PoE / PoE+ (802.3af/at. Not Cisco pre-standard)

- ISDN
- PBX
- Unknown

Optical

Supported SFPs

The following SFP types are supported. Use of other types of SFP is possible but correct operation is not guaranteed.

SFP Type SX

Manufacturer Part # - Avago AFBR-5705PZ / Apac LM28-C3S-TI-N-DD
Speed - 1Gb/s
Fiber Type - Multimode
Wavelength - 850nm
Connector Type - LC Duplex

SFP Type LX

Manufacturer Part # - Avago AFCT-5705PZ / Apac LS38-C3S-TC-N-DD
Speed - 1Gb/s
Fiber Type - Singlemode
Wavelength - 1310nm
Connector Type - LC Duplex

SFP Type ZX

Manufacturer Part # - Apac LS48-C3U-TC-N-DD
Speed - 1Gb/s
Fiber Type - Singlemode
Wavelength - 1550nm
Connector Type - LC Duplex

Ports (continued)

Optical



Setup

- Speed* - 1Gb/s
- MAC* - Factory set

Indication

Optical power indicated on home screen if supported by fitted SFP

Tests

Automatic mode selection depending on detection of Network / Remote Unit:

- No-Link (No network or Remote Unit detected)
- Link (Active network detected but no Remote Unit)
- Link-Remote (Remote Unit detected through network device)
- Remote (Remote Unit detected but no network)
- Active Remote (Active remote #1 - #12 detected)

Link Mode Tests (Active network detected but no Remote Unit)

- IPv4 Ping
- IPv6 Ping
- Traceroute v4
- Traceroute v6
- Netscan
- Hub Blink
- Auto
 - IPv4 Ping
 - IPv6 Ping
 - Traceroute v4
 - Traceroute v6
 - Netscan

Remote Mode Tests (Remote Unit detected but no network)

- Cable Performance
- Auto
 - Cable Performance

Link-Remote Mode Tests (Remote Unit detected through a network device)

- VoIP Performance
- Web Performance
- Video Performance
- CCTV Performance
- IPv4 Ping
- IPv6 Ping
- Traceroute v4
- Traceroute v6
- Netscan
- Hub Blink
- Auto
 - VoIP Performance
 - Web Performance
 - Video Performance
 - CCTV Performance
 - IPv4 Ping
 - IPv6 Ping
 - Traceroute v4
 - Traceroute v6
 - Netscan

Cable Tests



Wiremap Setup

- Cable Type*
 - Cat3 UTP
 - Cat3 STP
 - Cat5 UTP
 - Cat5 STP
 - Cat5e UTP
 - Cat5e STP
 - Cat6 UTP
 - Cat6 STP
 - Cat7
 - USOC
 - ETH S1236
 - ETH S1278
 - ETH U1236
 - ETH U1278
 - IND. M12
 - COAX RG59
- Color Scheme*
 - None
 - 568A
 - 568B
 - USOC
 - TERA
- Crossover Allowed* - Yes
 - No
- NVP* - Fixed 72%
 - Custom 59% - 89%

Termination Types supported and identified by icon

- Active Remote* - #1 - #12
- Remote Unit*

Single-ended Wiremap Tests

- Faults*
 - Open circuit by pin
 - Short circuit by pin
- Length of pair*
 - Meters / Feet (Set in System Setup)
 - Range 100m / 390ft

Double-ended Wiremap Tests

- I/D* - Active Remote # / Remote icon
- Indications on Active Remote* - Voltage Warning (>±10v on any pins)
 - Pass/Fail
- Indications on Remote Unit* - See below
- Faults*
 - Open circuit by pin
 - Short circuit by pin
 - Crossed pairs
 - Split pairs
 - Bridged shorts
 - Remote shorts
- Length of pair*
 - Meters / Feet (Set in System Setup)
 - Range 100m / 390ft
- Delay Skew* - Per pair (ns)

Cable Tests (continued)



Tone Generator

Setup

Tones - 3

Wire I/D - Tone applied to one of 8 pins relative to the other 7

- Tone applied across one of 4 pairs

Test

Audible tone detected using compatible tone probe

Cable Performance Test

Setup

IEEE802.3

Tick-box

Ticked

Fix Failure Threshold at 0

Fix Duration at 10 secs

Unticked

Allow editing of Threshold and Duration

Frame size

Fixed 1518 bytes

Frame Fill

Fixed

Duration

User-defined (hh:mm:ss up to 24 hours. Default 10 secs)

Failure Threshold

Number of frames (0 to 9999. Default 0)

Test

- Back-to-back frames transmitted to Remote for specified duration.

- Remote loops frames back

- Received frames checked and counted

Results

Test conditions

Line Rate

10 Mb/s

100 Mb/s

1000 Mb/s

Duplex

Full

Half

Frame Size

Frame Fill

Overall result

Pass (100% frames transmitted, 100% frames received and Failure threshold not exceeded)

Fail

Transmitted Frames

Count (0 to 10¹²)

Percentage (0 to 100% with colored bar indication - green if 100%, red if <100%)

Result

Pass (100%)

Fail (<100%)

(continued)

Cable Tests (continued)



Cable Performance Test

Results

Received Frames

Count (0 to 10¹²)

Percentage (0 to 100% with colored bar indication - green if 100%, red if <100%)

Result

Pass (100%)

Fail (<100%)

Errored Frames

Count (0 to 10¹²)

Percentage (0 to 100% with colored bar indication. Green if below threshold, red if ≥ threshold)

Result

Pass (<threshold)

Fail (≥ threshold)

Link-Remote Performance Tests

VoIP Performance Test

Fixed Settings

Frame size

Fixed 218 bytes

Frame Fill

Random

Setup

Number of Simultaneous Calls

User-defined. (Range 1 to 10,000 . Default 100)

Equivalent Information Rate calculated and displayed

Duration

User-defined (hh:mm:ss upto 24 hours. Default 10 secs)

Failure Threshold

Number of frames (0 to 99. Default 0)

Test

- Frames transmitted to Remote at calculated Frame Rate for specified duration
- Frames looped back by Remote
- Received frames checked and counted

(continued)



Link-Remote Performance Tests (continued)

VoIP Performance Test
Results

Test conditions

Line Rate

10 Mb/s

100 Mb/s

1000 Mb/s

Information Rate Mb/s

Duplex

Full

Half

Frame Size

Frame Fill

Overall result

Pass (100% frames transmitted and Failure threshold not exceeded)

Fail

Transmitted Frames

Count (0 to 10¹²)

Percentage (0 to 100% with colored bar indication - Green if 100%, red if <100%)

Result

Pass (100%)

Fail (<100%)

Received Frames

Count (0 to 10¹²)

Percentage (0 to 100%)

Errored Frames

Count (0 to 10¹²)

Percentage (0 to 100% with colored bar indication -, Green if 100%, red if <100%)

Result

Pass (100%)

Fail (>100%)

Web Performance Test

Fixed Settings

Frame size

Fixed 1518 bytes

Frame Fill

Random

Setup

Number of Simultaneous Sessions

User-defined. (Range 1 to 500. Default 10)

Equivalent Information Rate calculated and displayed

IR = 1.8 x No of sessions (Mb/s)

Equivalent Frame Rate calculated but not displayed

FR = IR / 1518 / 8 (fps)

Duration

User-defined (hh:mm:ss upto 24 hours. Default 10 secs)

Failure Threshold

Number of frames (0 to 99. Default 0)



Link-Remote Performance Tests (continued)

Web Performance Test
Test

See VoIP Performance Test

Results

See VoIP Performance Test

Video Performance Test

Fixed Settings

Frame size

Fixed 1518 bytes

Frame Fill

Random

Setup

Definition

SD

HD

Number of Simultaneous Video Streams

User-defined. (Range 1 to 70. Default 1)

Equivalent Information Rate calculated and displayed

Duration

User-defined (hh:mm:ss upto 24 hours. Default 10 secs)

Failure Threshold

Number of frames (0 to 99. Default 0)

Test

See VoIP Performance Test

Results

See VoIP Performance Test

CCTV Performance Test

Fixed Settings

Frame size

Fixed 1518 bytes

Frame Fill

Random

Setup

Resolution

VGA

720p

1080p

3MP

5MP

CODEC

H.264

MJPEG

(continued)



Link-Remote Performance Tests (continued)

CCTV Performance Test

Setup

Number of Cameras

User-defined. (Range 1 to 500. Default 1)

Equivalent Information Rate calculated and displayed

Duration

User-defined (0 to 99 secs. Default 10 secs)

Failure Threshold

Number of frames (0 to 99. Default 0)

Test

See VoIP Performance Test

Results

See VoIP Performance Test

Network Setup

IPv4

Setup

Addressing- DHCP

- Static

Numerical - Address

- Netmask

- Gateway

- DNS1

- DNS2

IPv6

Setup

Addressing - Stateful (DHCPv6)

- Stateless

- Static

Numerical - 128bit HEX IP address

Network Prefix - 64 bit

- 128 bit

Network Tests

Ping v4

Setup

Target - Numerical address

- URL (Store up to 10)

Count - 1 to 999999

Pause - 1 to 5 Sec

Length - 8 to 1000 bytes.

Results

Info - READY
- IN PROGRESS
- PASSED
- NO RESPONSE
- UNKNOWN HOST

Tx Count - 1 to 999999

Rx Count - 1 to 999999

Delay(ms) - Minimum



- Average
- Maximum

Ping v6

Setup

- Target* - IPv6 address
- URL (Store up to 10)
- Count* - 1 to 999999
- Pause* - 1 to 5 Sec
- Length* - 8 to 1000 bytes.

Results

- Info* - READY
- IN PROGRESS
- PASSED
- NO RESPONSE
- UNKNOWN HOST
- Tx Count* - 1 to 999999
- Rx Count* - 1 to 999999
- Delay (ms)* - Minimum
- Average
- Maximum

Traceroute v4

Setup

- Target* - Numerical address
- URL (Store up to 10)
- Max Hops* - 1 to 30
- Timeout* - 2 to 30 sec
- Type* - ICMP
- UDP

(continued)



Network Tests (continued)

Traceroute v4
Results

- Info*
 - READY
 - IN PROGRESS
 - PASSED
 - NO RESPONSE
 - UNKNOWN HOST
- Hop*
 - Numerical address
- Delay(ms)*
 - t1
 - t2
 - t3

Traceroute v6
Setup

- Target*
 - Numerical address
 - URL (Store up to 10)
- Max Hops*
 - 1 to 30
- Timeout*
 - 2 to 30 sec
- Type*
 - UDP

Results

- Info*
 - READY
 - IN PROGRESS
 - PASSED
 - NO RESPONSE
 - UNKNOWN HOST
- Hop*
 - Numerical address
- Delay (ms)*
 - t1
 - t2
 - t3

Netscan

Setup

- Address Type*
 - Local
 - Custom
 - IPv4 address
- Scan Range*
 - 0 (class C /24)
 - 1 (class C /20)
 - 2 (class B /16)

Results

- Total of IPv4 hosts
- Total of IPv6 hosts

Blink

Test

- Sequence*
 - Off/10/Off/100/Off/1000 Mb/s (RJ-45)
 - Off/On (Optical)



Storage

Configurations

Internal storage

Number of configurations - 2 (Current & Factory settings)

Results

Internal storage

Max Number of Jobs (Projects) - 50

Max Number of result sets per Job - 5000 depending on tests performed

Max total number of result sets - Up to 5000 depending on tests performed.

Results stored

Where available

- Wiremap
- Cable Performance
- VoIP Performance
- Web Performance
- Video Performance
- Netscan
- PoE Load
- Info: listening, assigned, DHCP failed
- DHCP or Static
- IPv4 Address
- IPv4 Netmask
- IPv4 Gateway
- IPv4 DNS1
- IPv4 DNS2
- Info: listening, assigned, DHCP failed
- Stateful (DHCPv6) or Stateless or Static
- IPv6 Address
- IPv6 Network Prefix, 64 bit or 128 bit
- IPv6 Link Address
- IPv6 DNS

(continued)



Storage (continued)

Export

- Port* - USB and Smartphone
- Format* - PDF
- CSV

Port # decode

Protocol

- Cisco Discovery Protocol (CDP)
- Link Layer Discovery Protocol (LLDP)
- Extreme Discovery Protocol (EDP)

System

Setup

Owner

- Details* - Name
- Company
- Address
- Phone

Preferences

- Language* - English
- French
- German
- Spanish
- Italian
- Portuguese
- Chinese
- Auto off* - Disabled
- 3 mins
- 10 mins
- 30 mins
- Backlight* - Always On
- Dims to 50% after 3 mins
- Length Units* - Meters
- Feet
- Date Format* - dd/mm/yy
- mm/dd/yy
- Time Format* - 12 hour
- 24 hour

Software update

- Update* - Via USB

General

Date/Time

Internal Clock

- Used for* -Time stamping results
- Autonomy* - Up to 1 day with battery removed



(continued)

General(continued)

Power

Battery

- Supported Types* - Standard Power module (4 x AA NiMH cells)
- Autonomy* - Up to 5 hours (power module only)
- Recharge time* - 3 hours (Power module only)
- Battery level Indication*
 - Full
 - 2/3
 - 1/3
 - Empty

Physical

Dimensions

- Length* - 175mm
- Width* - 80mm
- Depth* - 40mm

Weight

- Unit* - 0.22kg
- Batteries* - 0.18kg

Environmental

Temperature

- Operating* - 0°C to 40°C
- Storage* - - 20°C to 70°C

Relative Humidity

- Min* - 5%
- Max* - 90% non-condensing

Approvals

EMC

- EN 55022:2006 / A1:2007
- EN55024:1998 / A1:2001 / A2:2003

Safety

- IEC 60950-1:2005+A1:2009/EN 60950-1:2006+A1:2010

Remote Unit

Connectors

Test Ports

RJ45

- Used for* - Wiremap Test (Done by a companion Near-End Unit)
 - Performance Tests (Done by a companion Near-End Unit)
- Connector type* - Samtec Lifejack with user-replaceable contacts
- Insertion Cycles* - 500 min
- Location* - Left hand side

Optical

- Used for* - Performance Tests (Done by a companion Near-End Unit)
- Connector type* - SFP socket
- Location* - Left hand side

System Ports

USB

- Used for* - Software Update
- Class* - Host
- Connector type* - A



USB type - 1.1
Location - Top

Connectors (continued)

System Ports

Power

Used for - Battery charging
 - Mains powering via adaptor
Connector type - 2.5mm pin power jack
Polarity - Centre pin positive
Voltage - 12v
Current - 2 amps
Location - Bottom of power module

Controls

ON/OFF

Push button

Used for - Power ON/OFF
Location - Front

Autotest

Push button

Used for - Instructing connected Near-End Unit to start its Autotest
Location - Front

Displays

LEDs

Charger LED

Used for - Indication of charging status...
 Green - Battery is charging
 Off (with charger connected) - Battery is charging
 Green flashing - Battery is not charging

Color - Green
Location - Bottom of Power module

Power LED

Used for - Indication of battery and power status...
 Green - Power ON. Battery level sufficient for use
 Red - Power ON. Battery charge level low but still operational.
 Off - Power OFF

Color - Red / Green
Location - Front

RJ45 Link LED

Use - ON indicates link UP
Location - Adjacent to RJ45 socket, nearest top of tester
Color - Green

RJ45 Activity LED

Use - Flashing indicates link activity
Location - Adjacent to RJ45 socket, nearest bottom of tester
Color - Green

(continued)



Displays (continued)

Optical Link LED

Use - ON indicates Optical link UP

Location - Adjacent to SFP socket, nearest front of tester

Color - Green

Optical Activity LED

Use - Flashing indicates Optical link activity

Location - Adjacent to SFP socket, nearest back of tester

Color - Green

Link LED

Use - ON indicates connection to Near-End Unit

Location - Front

Color - Green

Status LED

Use - Flashing green indicates test in progress with Near-End Unit

- Green indicates test completed and passed

- Red indicates test completed and failed

Location - Front

Color - Red/Green

10M LED

Use - ON indicates 10Mb/s line rate

Location - Front

Color - Green

100M LED

Use - ON indicates 100Mb/s line rate

Location - Front

Color - Green

1000M LED

Use - ON indicates 1000Mb/s line rate

Location - Front

Color - Green

Ports

RJ45

Fixed Setup

Speed - Auto negotiated

Duplex -- Auto negotiated

MAC - Factory set

Functions

Controlled automatically by connected Near-End Unit

Performance test with connected Near-End Unit

- Regenerate all traffic addressed to this unit's MAC address

- Swap Source/Destination MAC

Wiremap test with connected Near-End Unit

- Function identical to Active Remote.

(continued)



Ports (continued)

Optical

Supported SFPs

The following SFP types are supported. Use of other types of SFP is possible but correct operation is not guaranteed.

SFP Type SX

*Manufacturer Part # - Avago AFBR-5705PZ / Apac LM28-C3S-TI-N-DD
Speed - 1Gb/s
Fiber Type - Multimode
Wavelength - 850nm
Connector Type - LC Duplex*

SFP Type LX

*Manufacturer Part # - Avago AFCT-5705PZ / Apac LS38-C3S-TC-N-DD
Speed - 1Gb/s
Fiber Type - Singlemode
Wavelength - 1310nm
Connector Type - LC Duplex*

SFP Type ZX

*Manufacturer Part # - Apac LS48-C3U-TC-N-DD
Speed - 1Gb/s
Fiber Type - Singlemode
Wavelength - 1550nm
Connector Type - LC Duplex*

Fixed Setup

*Speed - 1Gb/s
MAC - Factory set*

Function

Performance test with connected Near-End Unit
- Regenerate all traffic addressed to this unit's MAC address
- Swap Source/Destination MAC

Software update

Via USB key

General

Power

Battery

Supported Types - Standard Power module (4 x AA NiMH cells)

Autonomy - Up to 5 hours (power module only)

Recharge time - 3 hours (Power module only)

(continued)



General (continued)

Physical

Dimensions

Length - 175mm
Width - 80mm
Depth - 40mm

Weight

Unit - 0.22kg
Batteries - 0.18kg

Environmental

Temperature

Operating - 0°C to 40°C
Storage -20°C to 70°C

Relative Humidity

Min 5%
Max 90% non-condensing

Approvals

EMC

EN 55022:2006 / A1:2007
EN55024:1998 / A1:2001 / A2:2003

Safety

IEC 60950-1:2005+A1:2009/EN 60950-1:2006+A1:2010

Glossary, abbreviations and acronyms

Term	Description
10M-HD	10 Mb/s Half Duplex
10M-FD	10 Mb/s Full Duplex
100M-HD	100 Mb/s Half Duplex
100M-FD	100 Mb/s Full Duplex
1000M-HD	1000 Mb/s Half Duplex
1000M-FD	1000 Mb/s Full Duplex
Broadcast	Communication from single sender to all connected receivers
CCTV	Closed Circuit Television
CRC	Cyclic Redundancy Check
CSV	Comma Separated Value file format
DHCP	Dynamic Host Configuration Protocol
DNS	Domain Name System
ICMP	Internet Control Message Protocol
IP	Internet Protocol
IPv4	Internet Protocol version 4
Static	IP address assigned manually by the operator
Dynamic	IP address assigned automatically using DHCP
IPv6	Internet Protocol version 6
Stateful	IP address assigned automatically using DHCPv6
Stateless	IP address assigned automatically using ICMPv6
Static	IP address assigned manually by the operator
LAN	Local Area Network
MAC	Media Access Control
MDI	Medium Dependent Interface
MDIX	Medium Dependent Interface Crossover
Multicast	Communication between single sender and multiple receivers
NVP	Nominal Velocity of Propagation of signals in a cable, expressed as a percentage of the speed of light in a vacuum. Can be determined using cable manufacturers' data or experimentally using a known cable length.
PDF	Portable Document Format
PoE	Power over Ethernet
PoE+	Power over Ethernet which exceeds the IEEE 802.3af limit of 12.95 watts
QinQ	Ethernet frame format that allows multiple VLAN headers to be inserted into a single frame
RJ45	Registered Jack standard for a modular connector using 8 conductors
Rx	Receive



SFP	Small Form-factor Pluggable
SSID	Service Set Identifier
STP	Shielded Twisted Pair
Tx	Transmit
UDP	User Datagram Protocol
Unicast	Communication between single sender and single receiver
URL	Uniform Resource Locator
USB	Universal Serial Bus
UTP	Unshielded Twisted Pair
VoIP	Voice over Internet Protocol
Wi-Fi	Wireless Fidelity



IDEAL NETWORKS

IDEAL INDUSTRIES LIMITED
Stokenchurch House, Oxford Road, Stokenchurch,
High Wycombe, Bucks, HP14 3SX, UK.

www.idealnetworks.net

A subsidiary of IDEAL INDUSTRIES INC.



IDEAL INDUSTRIES, INC.