

40 W + 40 W stereo amplifier with mute and standby

Datasheet – production data

Features

- Wide supply voltage range (up to ± 33 V)
- Split supply
- High output power
- 40 W + 40 W into 8Ω with $V_S = \pm 26$ V and THD = 10%
- No “pop” at turn on/off
- Mute (“pop”-free)
- Standby feature (low I_Q)
- Short-circuit protection
- Thermal overload protection

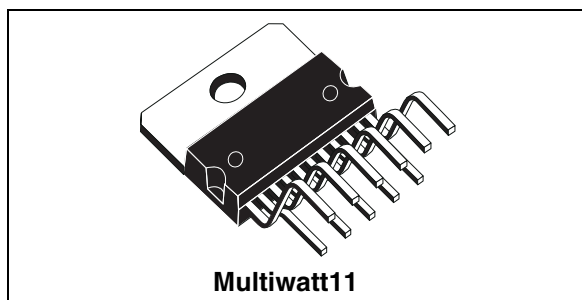

Description

The TDA7292 is a class-AB dual audio power amplifier assembled in a Multiwatt package.

It has been specifically designed for high-quality sound applications such as hi-fi music centers and stereo TV sets.

Table 1. Device summary

| Order code | Operating temp. range | Package | Packaging |
|------------|-----------------------|-------------|-----------|
| TDA7292 | 0° to 70° C | Multiwatt11 | Tube |

Figure 1. Applications circuit

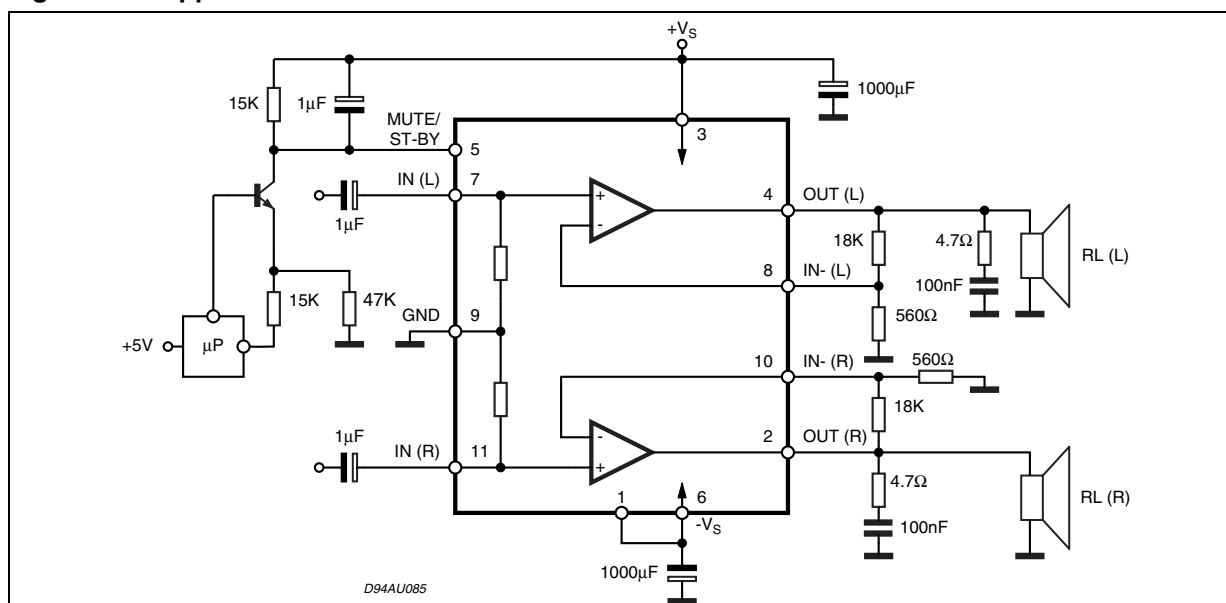

Contents

| | | |
|----------|---|-----------|
| 1 | Pin description | 5 |
| 2 | Electrical specifications | 6 |
| | 2.1 Absolute maximum ratings | 6 |
| | 2.2 Thermal data | 6 |
| | 2.3 Electrical specifications | 6 |
| 3 | Characterization curves | 8 |
| 4 | Mute and standby modes | 13 |
| 5 | Applications information | 14 |
| | 5.1 Applications with dual supply | 14 |
| | 5.2 Applications with single supply | 17 |
| 6 | Package mechanical data | 20 |
| 7 | Revision history | 21 |

List of tables

| | | |
|----------|--|----|
| Table 1. | Device summary | 1 |
| Table 2. | Absolute maximum ratings | 6 |
| Table 3. | Thermal data | 6 |
| Table 4. | Electrical specifications | 6 |
| Table 5. | Mute and standby thresholds on pin 5 | 13 |
| Table 6. | Recommended values | 15 |
| Table 7. | Document revision history | 21 |

List of figures

| | | |
|------------|--|----|
| Figure 1. | Applications circuit | 1 |
| Figure 2. | Pin connections (top view) | 5 |
| Figure 3. | Quiescent current vs. supply voltage | 8 |
| Figure 4. | Frequency response | 8 |
| Figure 5. | Output power vs. supply voltage | 9 |
| Figure 6. | Output power vs. supply voltage | 9 |
| Figure 7. | Output power vs. supply voltage | 9 |
| Figure 8. | THD vs. output power | 10 |
| Figure 9. | THD vs. output power | 10 |
| Figure 10. | THD vs. output power | 10 |
| Figure 11. | Quiescent current vs. voltage on pin 5 | 11 |
| Figure 12. | Attenuation vs. voltage on pin 5 | 11 |
| Figure 13. | Crosstalk vs. frequency | 11 |
| Figure 14. | Power dissipation vs. output power | 12 |
| Figure 15. | Power dissipation vs. output power | 12 |
| Figure 16. | Power dissipation vs. output power | 12 |
| Figure 17. | Mute and standby thresholds on pin 5 | 13 |
| Figure 18. | Test and applications circuit (dual supply) | 14 |
| Figure 19. | PCB layout, solder side | 16 |
| Figure 20. | PCB layout, component side | 16 |
| Figure 21. | PCB component placement | 17 |
| Figure 22. | Typical applications circuit (single supply) | 17 |
| Figure 23. | PCB layout, solder side | 18 |
| Figure 24. | PCB layout, component side | 18 |
| Figure 25. | PCB component placement | 19 |
| Figure 26. | Multiwatt11 outline drawing and dimensions | 20 |

1 Pin description

Figure 2. Pin connections (top view)

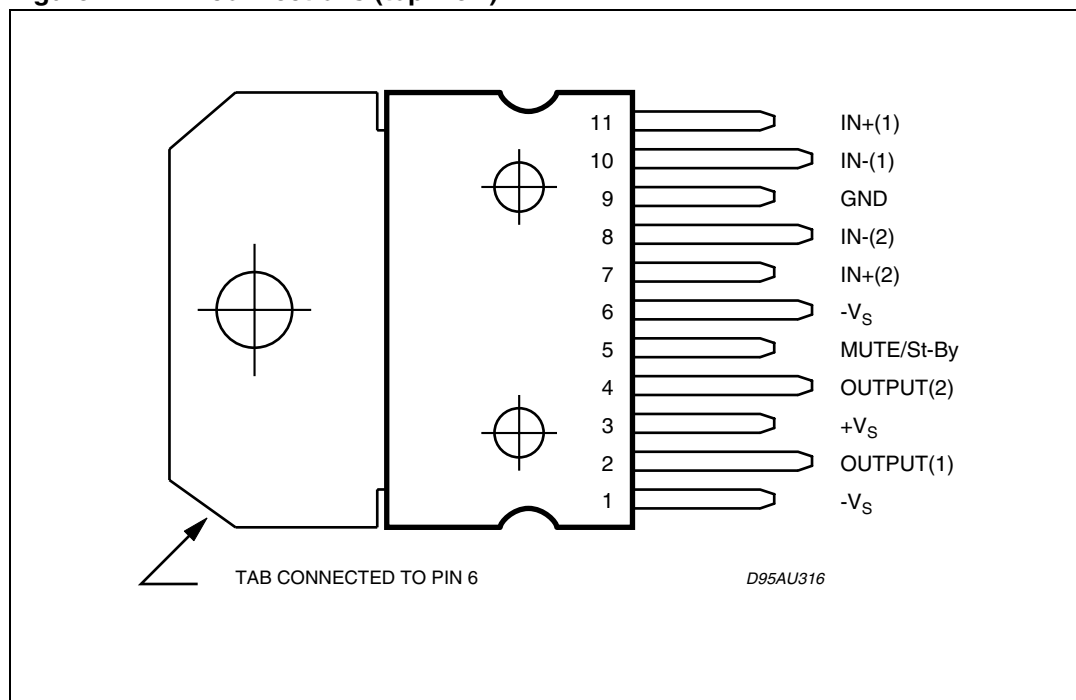

2 Electrical specifications

2.1 Absolute maximum ratings

Table 2. Absolute maximum ratings

| Symbol | Parameter | Value | Unit |
|-----------|---|------------|------------------|
| V_S | DC supply voltage | ± 35 | V |
| I_O | Output peak current (internally limited) | 5 | A |
| P_{tot} | Power dissipation $T_{case} = 70^\circ\text{C}$ | 40 | W |
| T_{op} | Operating temperature | -20 to 85 | $^\circ\text{C}$ |
| T_j | Junction temperature | -40 to 150 | $^\circ\text{C}$ |
| T_{stg} | Storage temperature | -40 to 150 | $^\circ\text{C}$ |

2.2 Thermal data

Table 3. Thermal data

| Symbol | Parameter | Min | Typ | Max | Unit |
|------------------|--------------------------------------|-----|-----|-----|---------------------------|
| $R_{th\ j-case}$ | Thermal resistance, junction to case | - | 1.5 | - | $^\circ\text{C}/\text{W}$ |

2.3 Electrical specifications

Unless otherwise stated, the results in [Table 4](#) below are given for the conditions: $V_S = \pm 26\text{ V}$, R_L (load) = 8 Ω , R_S (source) = 50 Ω , $f = 1\text{ kHz}$, $G_V = 30\text{ dB}$, and $T_{amb} = 25^\circ\text{ C}$. See also the test circuit in [Figure 18 on page 14](#).

Table 4. Electrical specifications

| Symbol | Parameter | Condition | Min | Typ | Max | Unit |
|------------|----------------------------------|--|---------|----------|----------|------|
| V_S | Supply voltage range | - | ± 8 | - | ± 33 | V |
| I_q | Total quiescent current | - | - | 50 | 130 | mA |
| V_{OS} | Output offset voltage | - | -20 | - | 20 | mV |
| I_b | Non-inverting input bias current | - | - | 500 | - | nA |
| P_o | Output power | THD = 10%: $R_L = 8\ \Omega$, $V_S = \pm 26\text{ V}$ $R_L = 4\ \Omega$, $V_S = \pm 18\text{ V}$ | - | 40 31 | - | W |
| | | THD = 1%: $R_L = 8\ \Omega$, $V_S = \pm 26\text{ V}$ $R_L = 4\ \Omega$, $V_S = \pm 18\text{ V}$ | - | 30 24 | - | |
| I_{Peak} | Peak output current | Internally limited | - | 5 | - | A |
| THD | Total harmonic distortion | $P_o = 1\text{ W}$ | - | 0.02 | - | % |

Table 4. Electrical specifications (continued)

| Symbol | Parameter | Condition | Min | Typ | Max | Unit |
|---|---|--|------|------|------|--------------------|
| C_T | Crosstalk | $f = 1 \text{ kHz}$ | - | 70 | - | dB |
| SR | Slew rate | - | - | 11 | - | V/ms |
| G_{OL} | Open-loop gain | - | - | 80 | - | dB |
| eN | Total input noise | $f = 20 \text{ Hz to } 22 \text{ kHz}$ | - | 4 | - | μV |
| R_i | Input resistance | - | - | 20 | - | $\text{k}\Omega$ |
| SVRR | Supply voltage rejection ratio | - | - | 75 | - | dB |
| T_j | Junction temperature at thermal shut-down | - | - | 145 | - | $^{\circ}\text{C}$ |
| Mute mode (see also Table 5 on page 13) | | | | | | |
| V_{T_MUTE} | Mute/play threshold | - | -7 | -6 | -5 | V |
| A_{MUTE} | Mute attenuation | - | - | 75 | - | dB |
| Standby mode (see also Table 5 on page 13) | | | | | | |
| V_{T_STBY} | Standby/mute threshold | - | -3.5 | -2.5 | -1.5 | V |
| A_{STBY} | Standby attenuation | - | - | 110 | - | dB |
| I_{q_STBY} | Quiescent current in standby | - | - | 8 | - | mA |

3 Characterization curves

Figure 3. Quiescent current vs. supply voltage

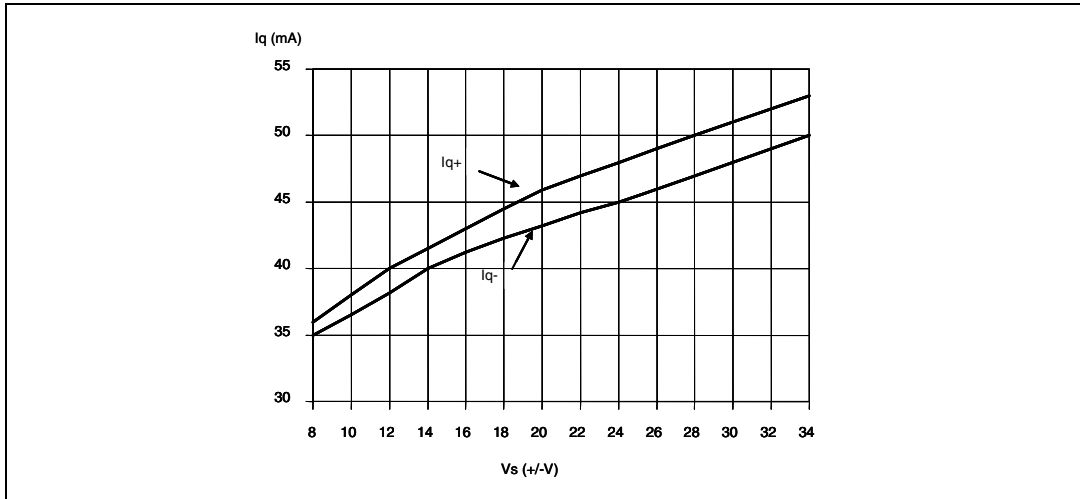

Figure 4. Frequency response

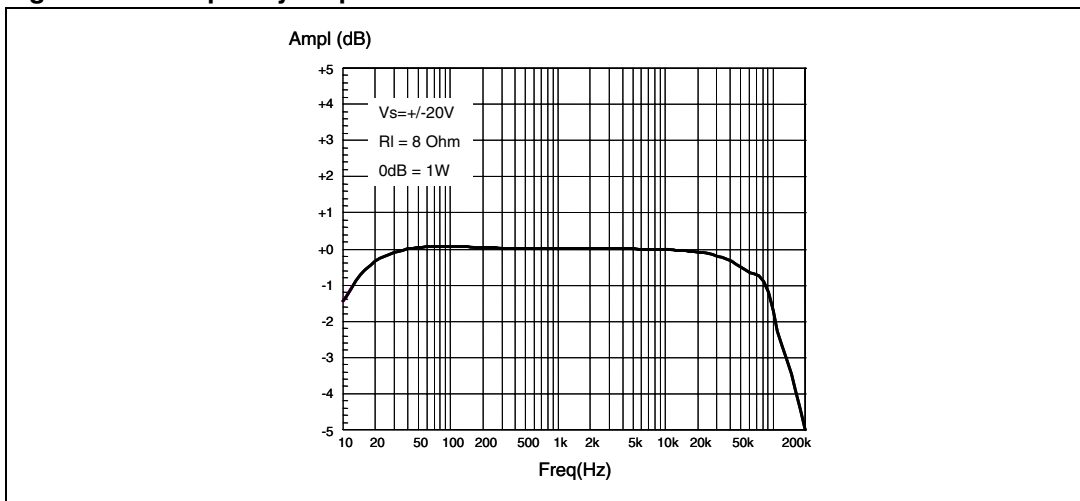

Figure 5. Output power vs. supply voltage

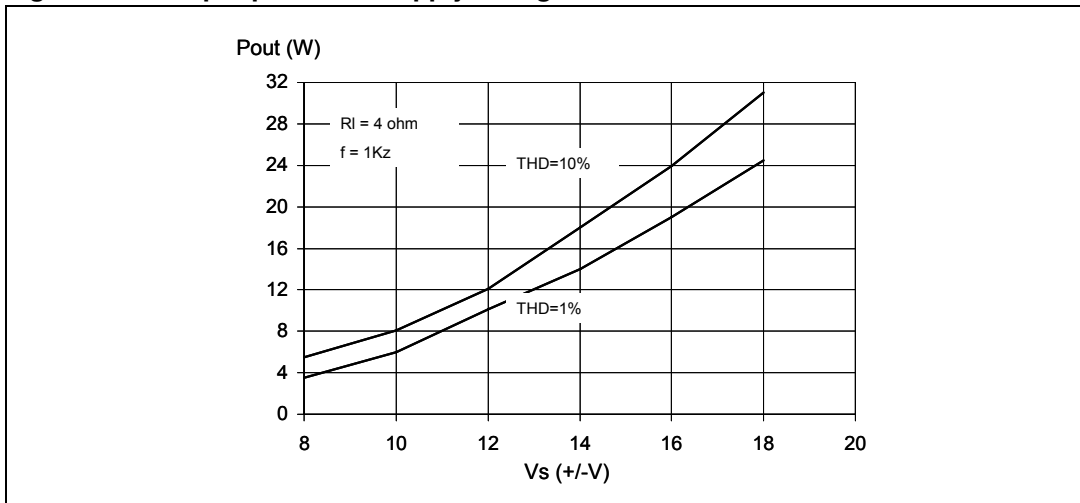

Figure 6. Output power vs. supply voltage

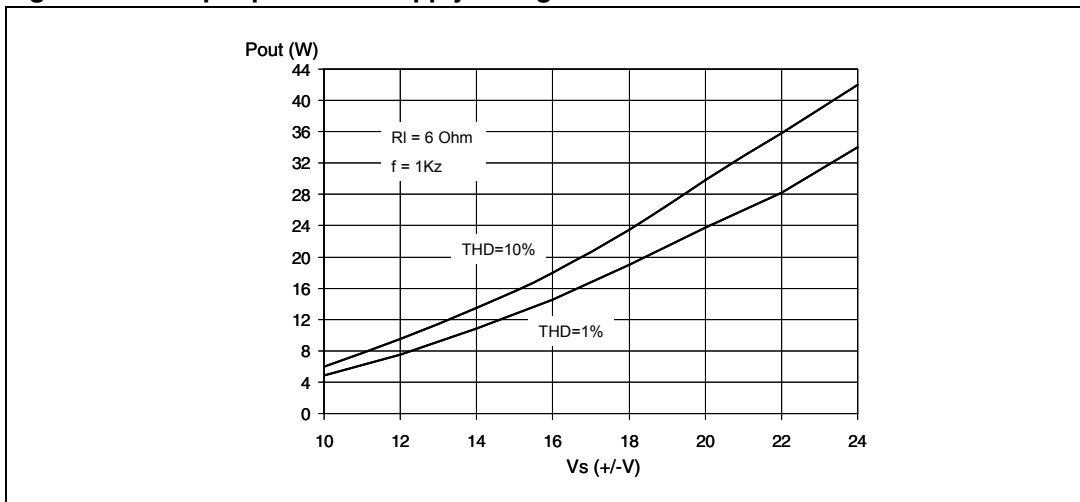

Figure 7. Output power vs. supply voltage

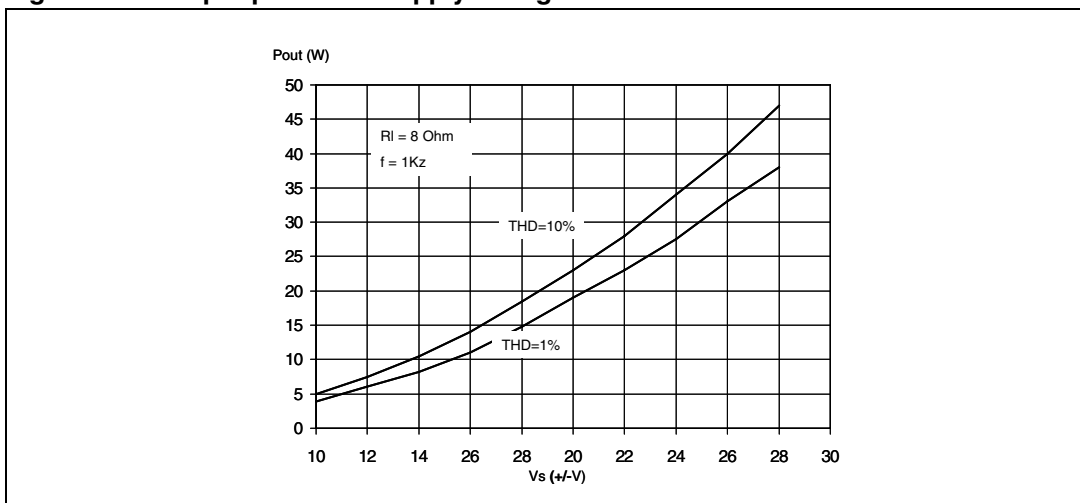

Figure 8. THD vs. output power

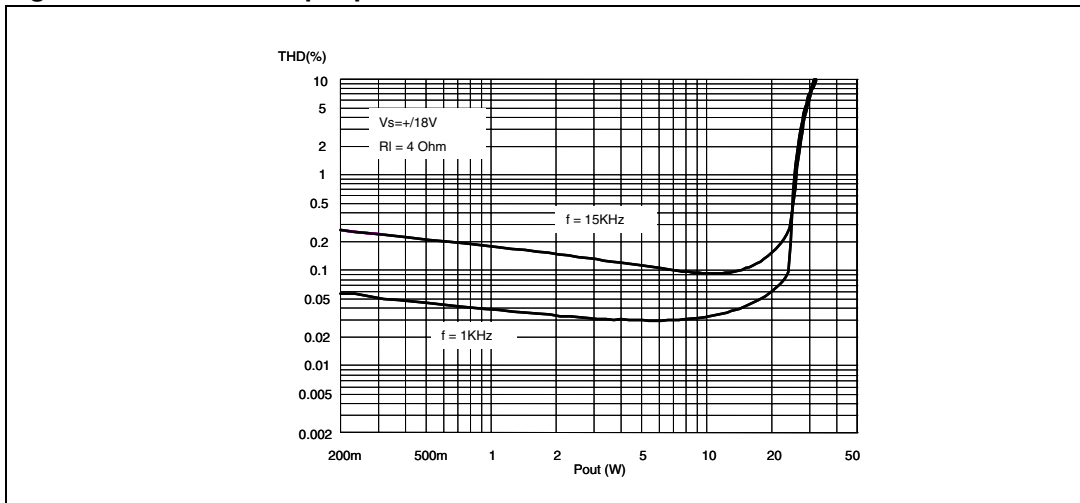

Figure 9. THD vs. output power

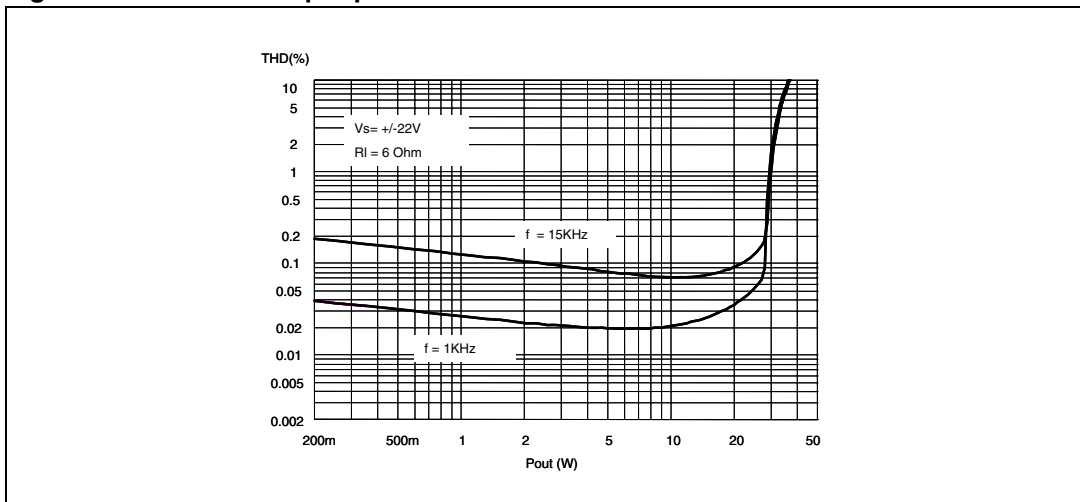

Figure 10. THD vs. output power

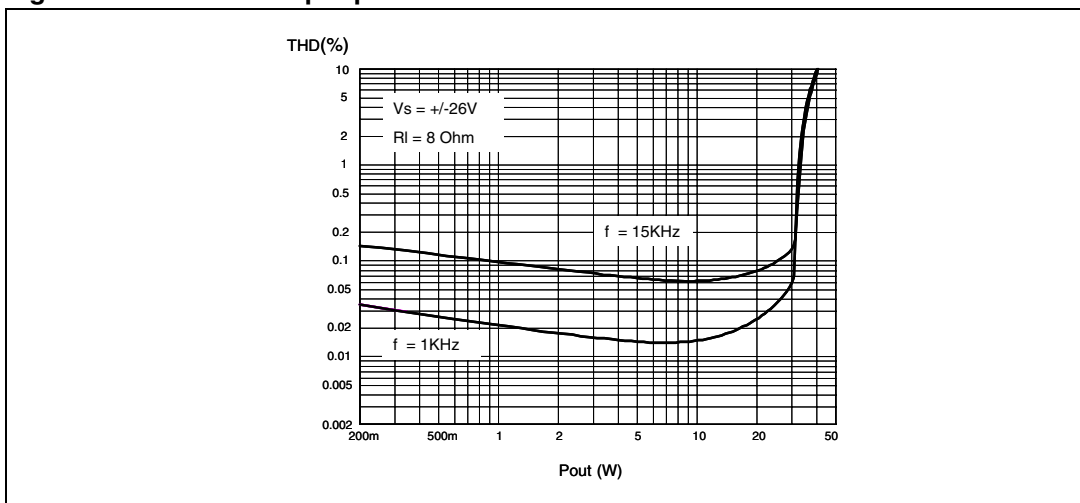

Figure 11. Quiescent current vs. voltage on pin 5

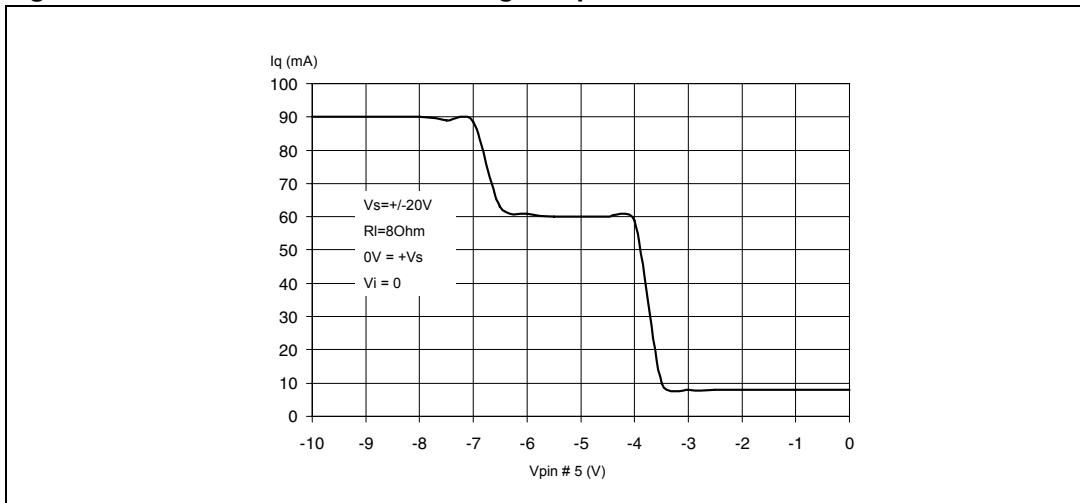

Figure 12. Attenuation vs. voltage on pin 5

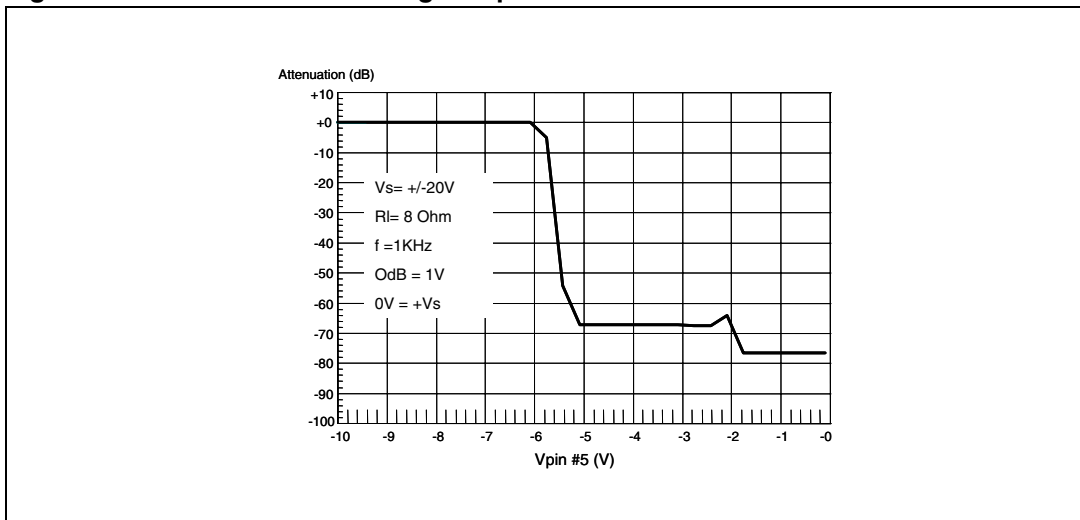

Figure 13. Crosstalk vs. frequency

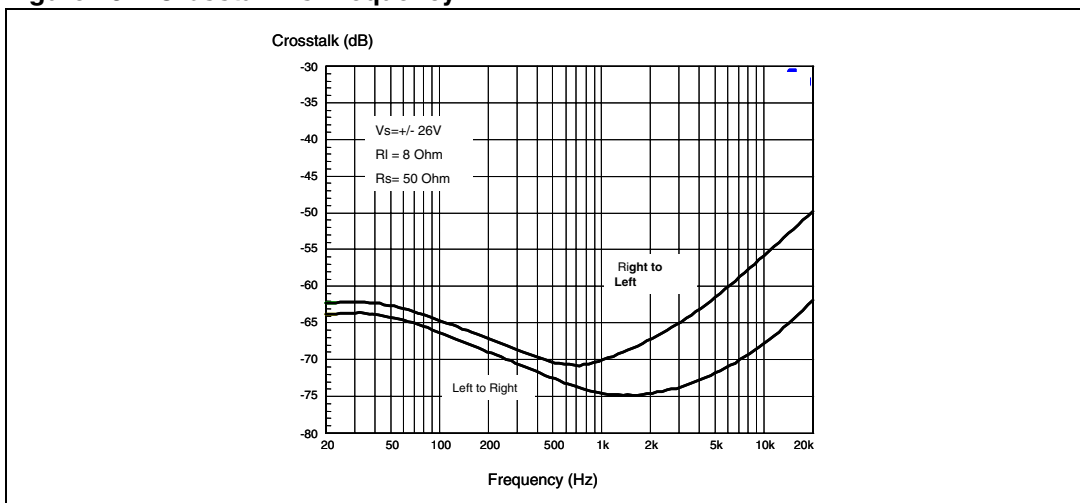

Figure 14. Power dissipation vs. output power

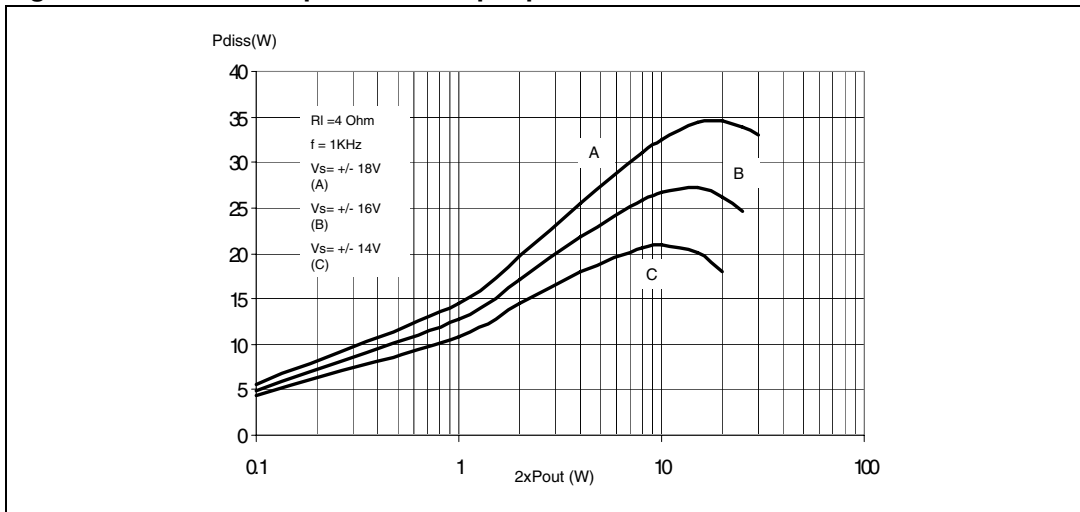

Figure 15. Power dissipation vs. output power

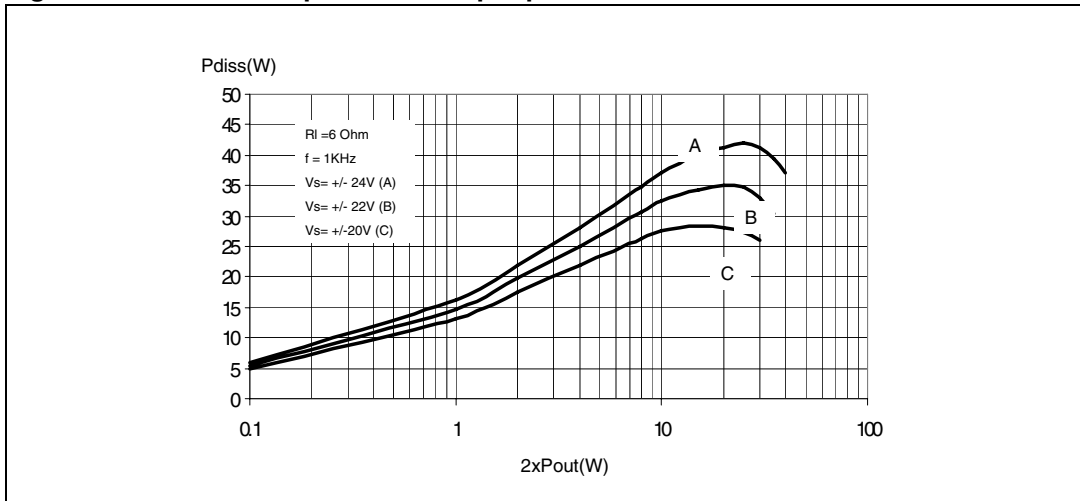
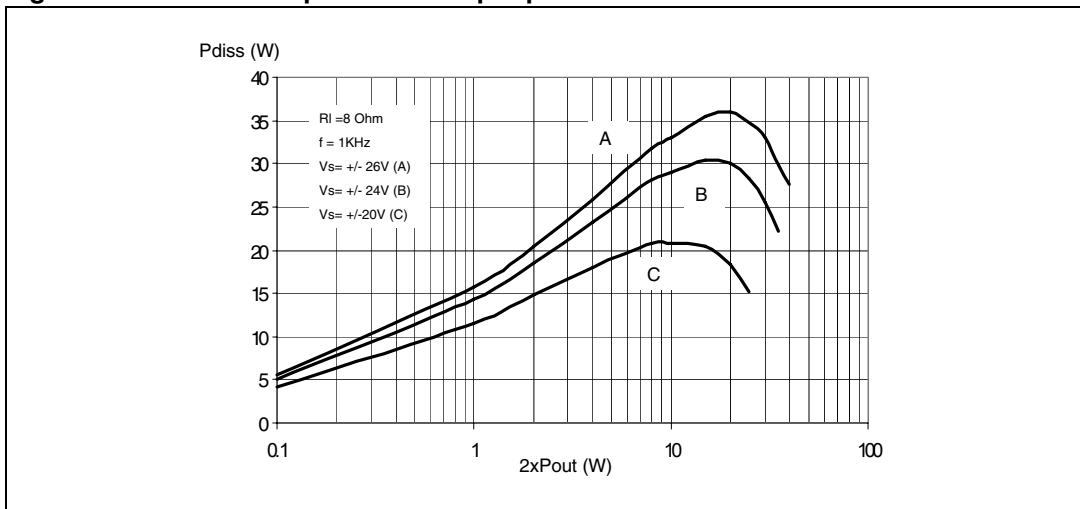

Figure 16. Power dissipation vs. output power



4 Mute and standby modes

Pin 5 (MUTE/STANDBY) controls the amplifier status by two different thresholds referenced to $+V_S$ as given in [Table 5](#) below. See also [Table 4: Electrical specifications on page 6](#).

Table 5. Mute and standby thresholds on pin 5

| Nominal voltage on pin 5, V_{PIN5} | Mode | Remarks |
|--|---------|---|
| $> +V_S - 2.5 \text{ V}$ | Standby | Output stages turned off |
| $> +V_S - 6.0 \text{ V}, < +V_S - 2.5 \text{ V}$ | Mute | Output stages turned on, amplifiers muted |
| $< +V_S - 6.0 \text{ V}$ | Play | Amplifiers active |

Figure 17. Mute and standby thresholds on pin 5

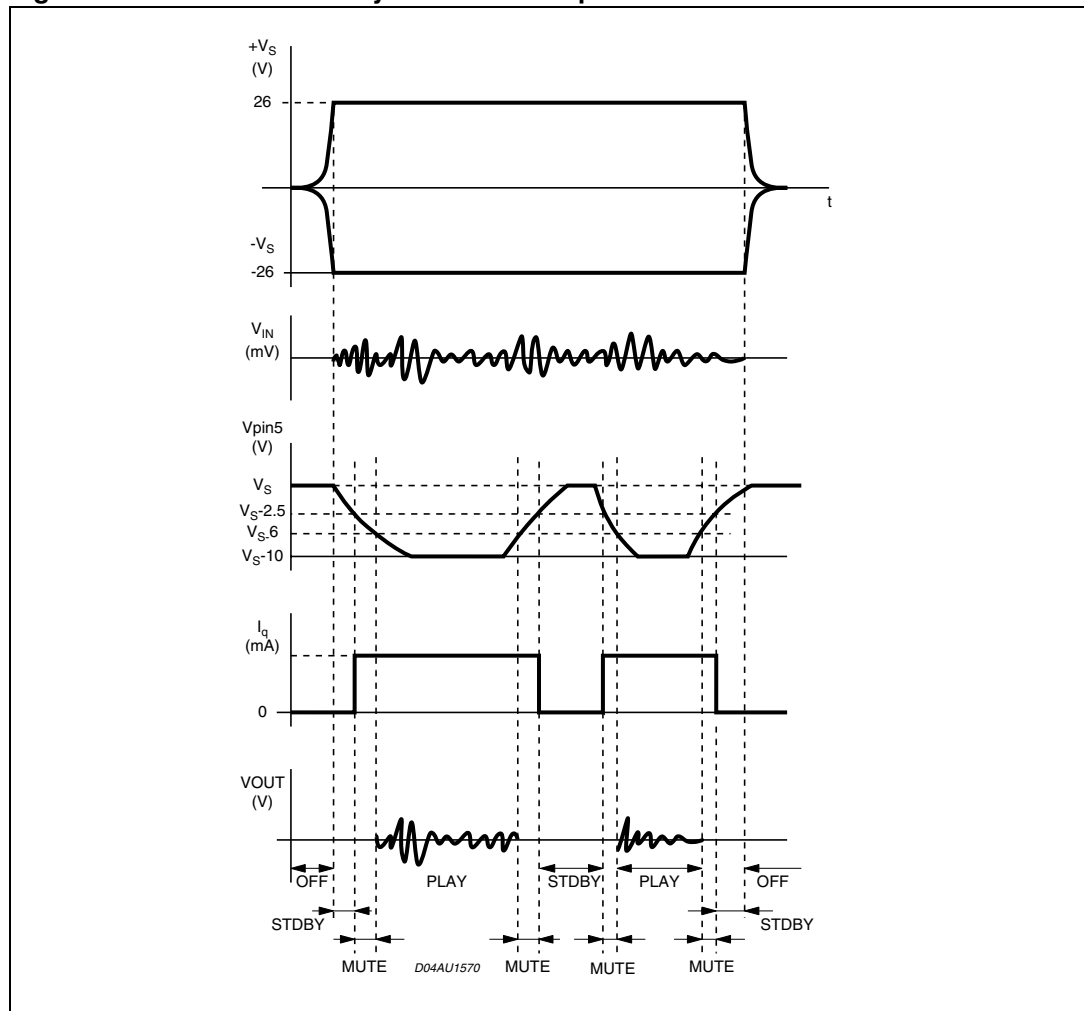

5 Applications information

Warning: SOA protection:

If the TDA7292 is operated without a load connected to the output terminals, the SOA protection circuit could be activated when a high amplitude and high frequency signal is applied to the input. The frequency and amplitude of the signal able to trigger the protection is a function also of the supply voltage level used. If the above mentioned condition is possible when the speakers are not connected, it is recommended to connect the input to ground or add a dummy resistive load. For example, a 1-kΩ / 1-W resistor can be used at Vcc = ±26 V. If a lower supply voltage is used, the resistor value must be decreased accordingly.

5.1 Applications with dual supply

Figure 18. Test and applications circuit (dual supply)

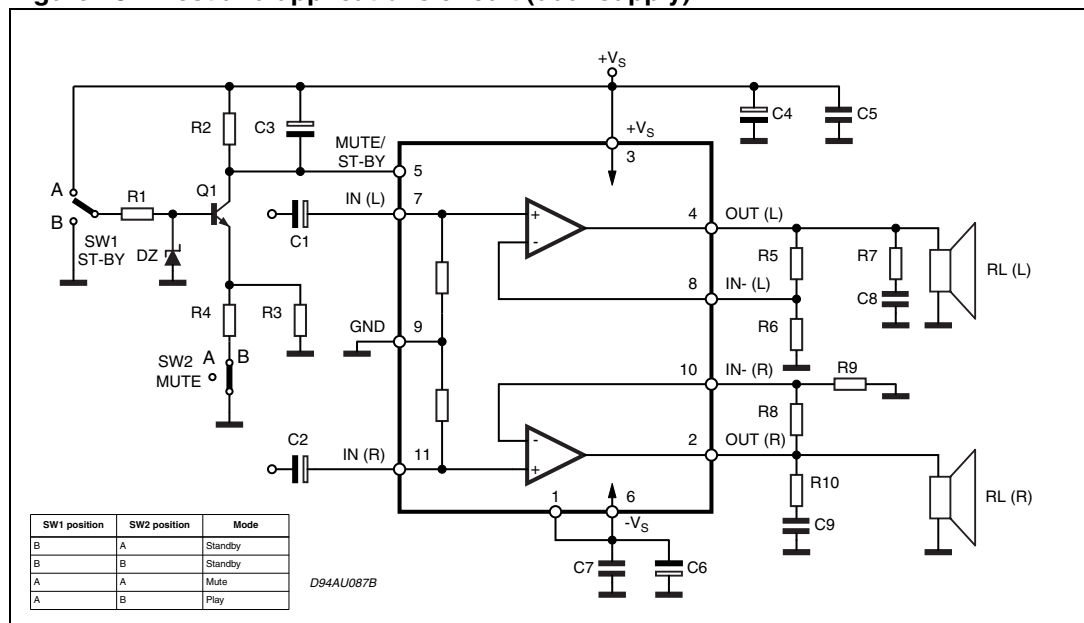

Table 6. Recommended values

| Component | Recommended value | Purpose | Larger than recommended value | Smaller than recommended value |
|-----------|-------------------|---|-------------------------------------|-------------------------------------|
| R1 | 10 k Ω | Mute circuit | Decrease in DZ biasing current | - |
| R2 | 15 k Ω | Mute circuit | V _{PIN5} shifted downwards | V _{PIN5} shifted upwards |
| R3 | 47 k Ω | Mute circuit | V _{PIN5} shifted upwards | V _{PIN5} shifted downwards |
| R4 | 15 k Ω | Mute circuit | V _{PIN5} shifted upwards | V _{PIN5} shifted downwards |
| R5, R8 | 18 k Ω | Closed-loop gain setting ⁽¹⁾ | Increase in gain | - |
| R6, R9 | 560 Ω | | Decrease in gain | - |
| R7, R10 | 4.7 Ω | Frequency stability | Danger of oscillation | Danger of oscillation |
| C1, C2 | 1 μ F | Input AC coupling | - | Higher low-frequency cutoff |
| C3 | 1 μ F | Standby/mute time constant | Larger on/off time | Smaller on/off time |
| C4, C6 | 1000 μ F | Supply voltage decoupling | - | Danger of oscillation |
| C5, C7 | 0.1 μ F | Supply voltage decoupling | - | Danger of oscillation |
| C8, C9 | 0.1 μ F | Frequency stability | - | - |
| Dz | 5.1 V | Mute circuit | - | - |
| Q1 | BC107 | Mute circuit | - | - |

1. Closed-loop gain must be >29 dB

Note: The PCB layout shown in [Figure 19](#), [Figure 20](#), and [Figure 21](#) is common to the pin-to-pin compatible devices TDA7269A, TDA7265 and TDA7265B.

Figure 19. PCB layout, solder side

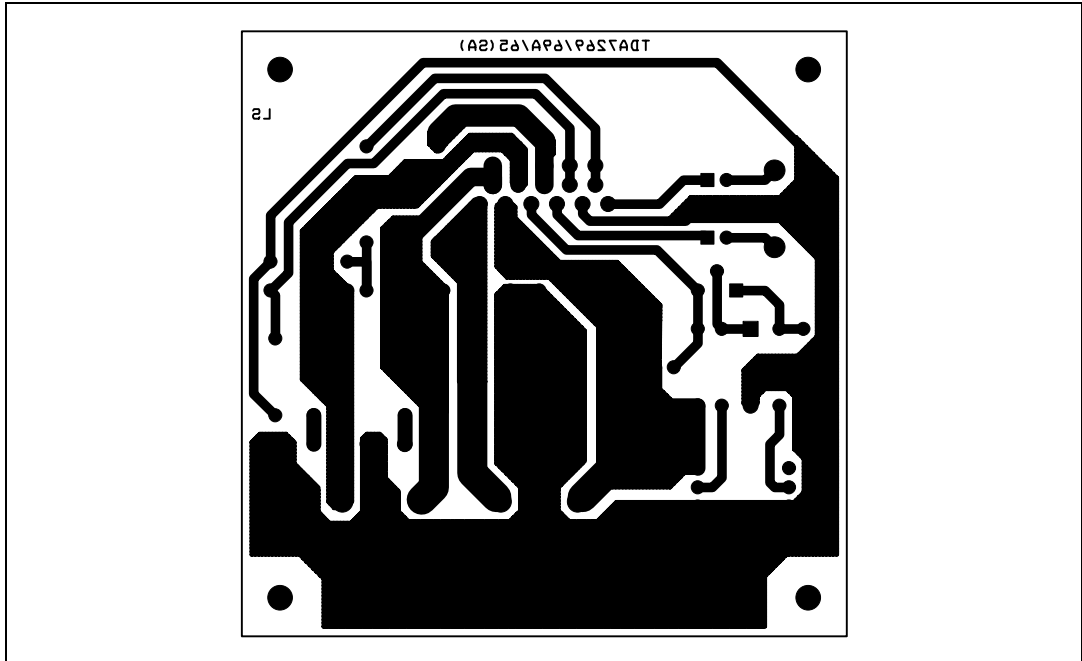

Figure 20. PCB layout, component side

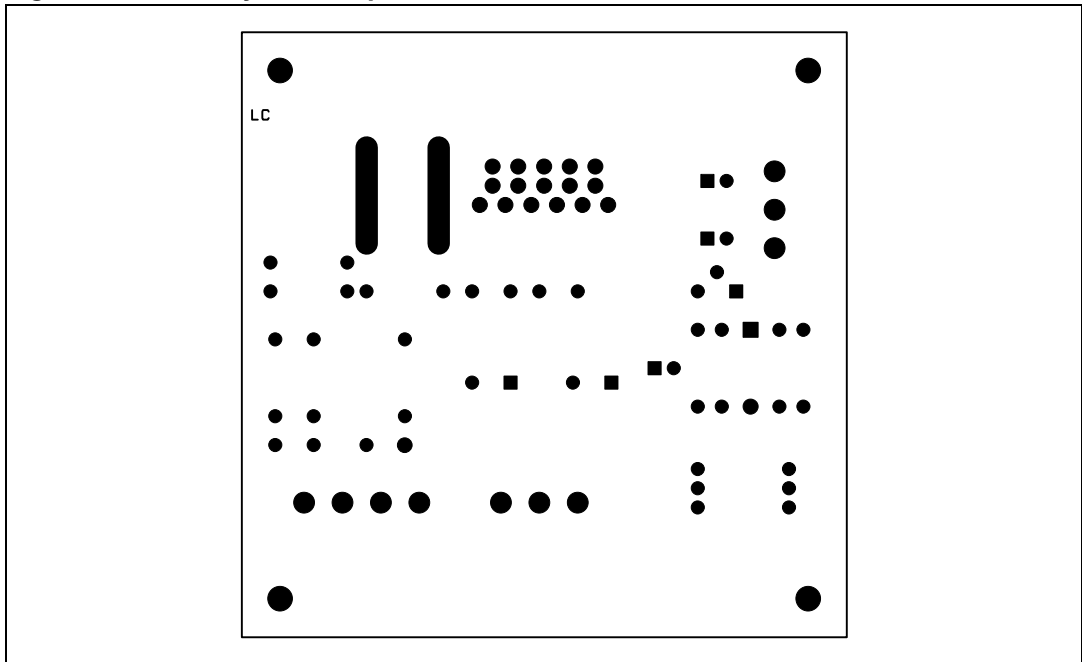
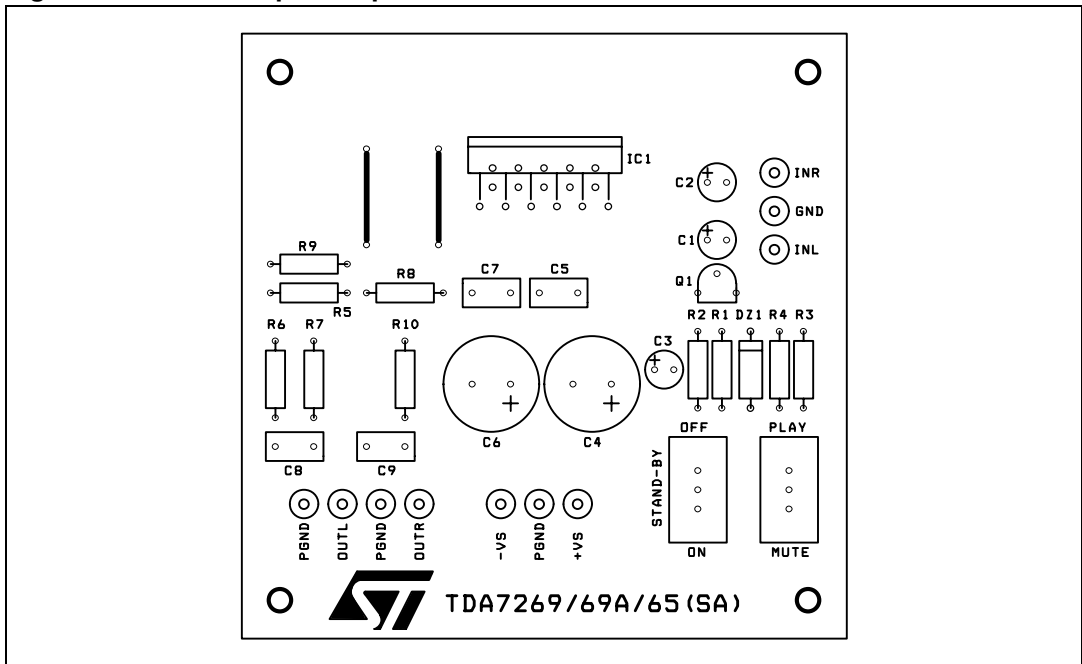
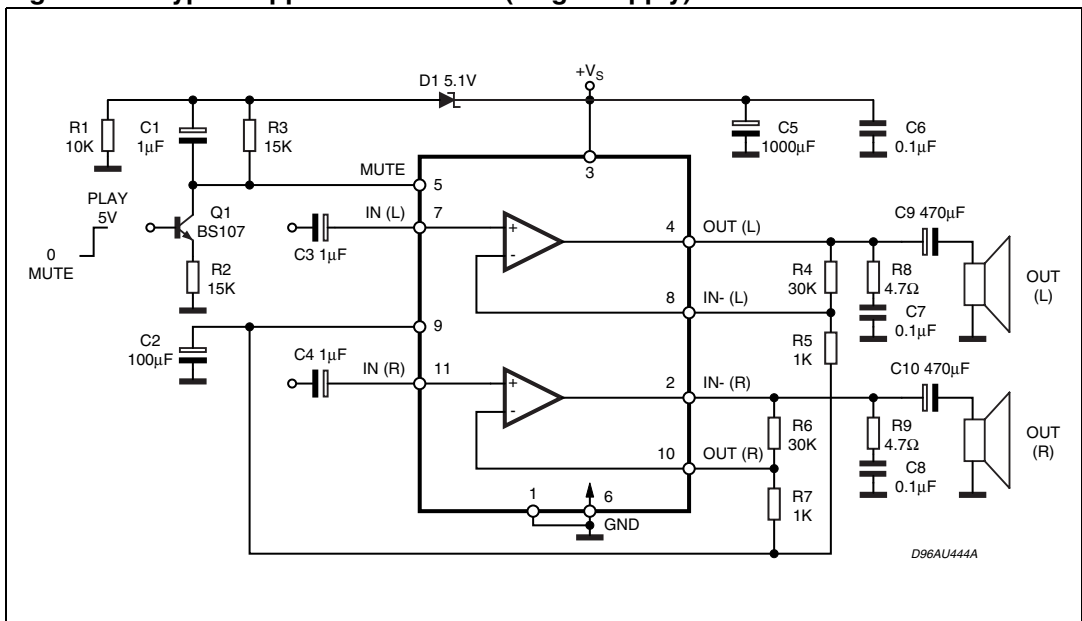

Figure 21. PCB component placement



5.2 Applications with single supply

Figure 22. Typical applications circuit (single supply)



Note: The PCB layout shown in [Figure 23](#), [Figure 24](#), and [Figure 25](#) is common to the pin-to-pin compatible devices TDA7269A, TDA7265, and TDA7265B.

Figure 23. PCB layout, solder side

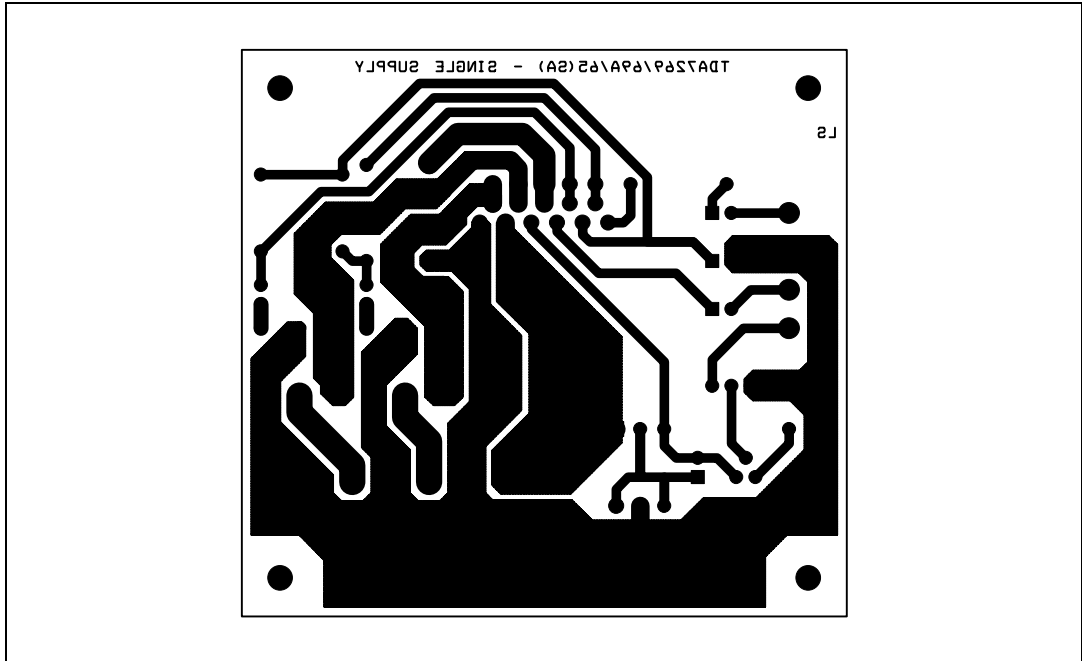

Figure 24. PCB layout, component side

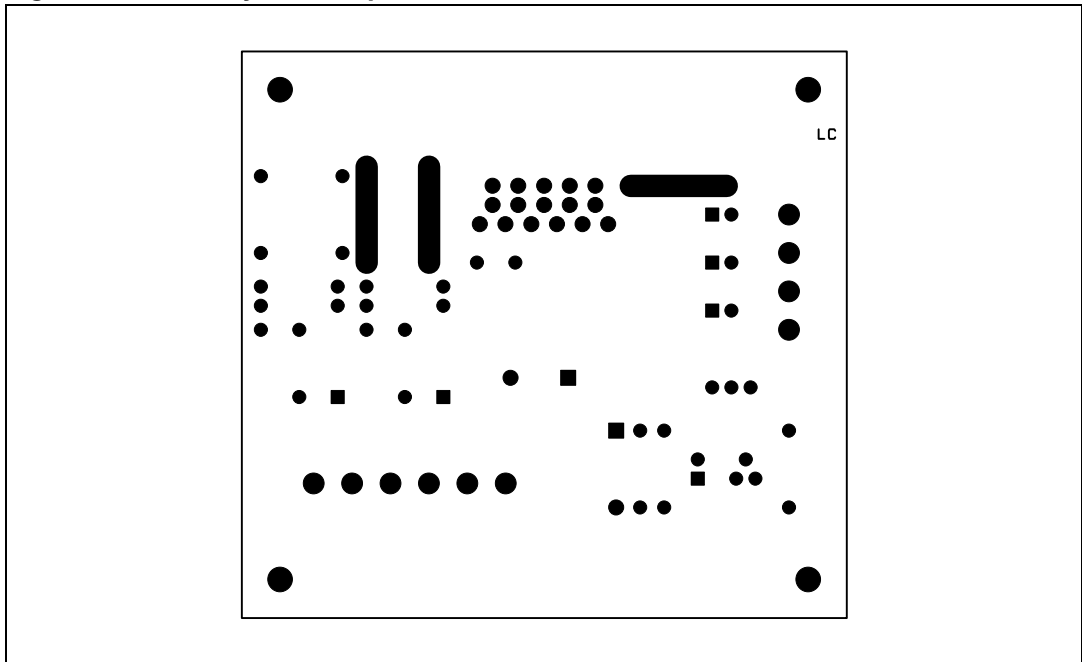
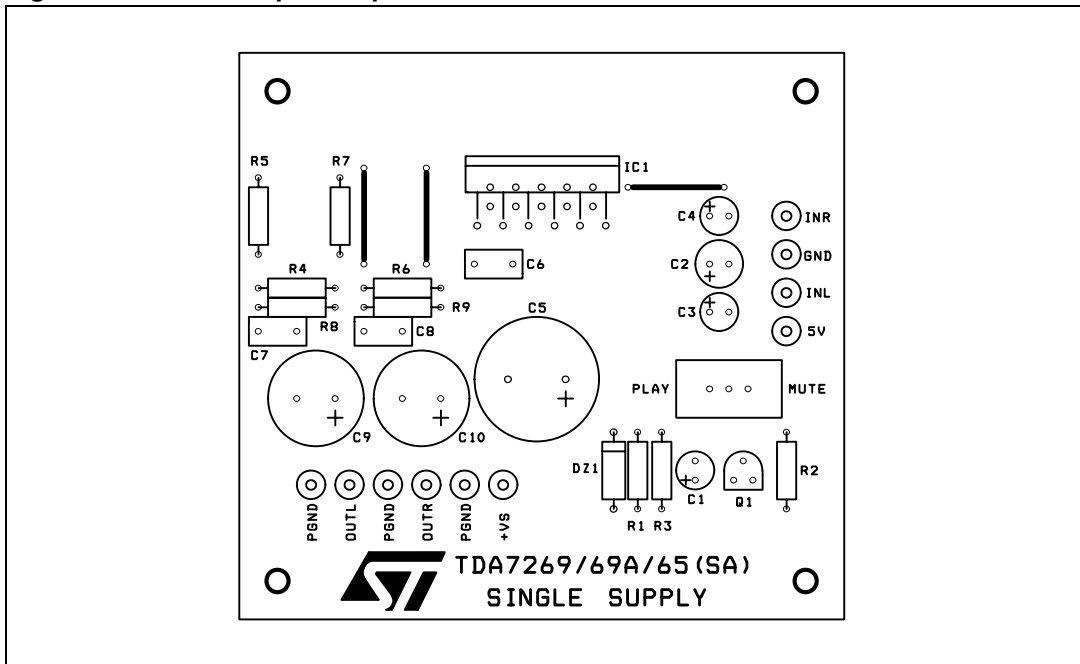

Figure 25. PCB component placement



6 Package mechanical data

The TDA7292 comes in an 11-pin Multiwatt package.

Figure 26. Multiwatt11 outline drawing and dimensions

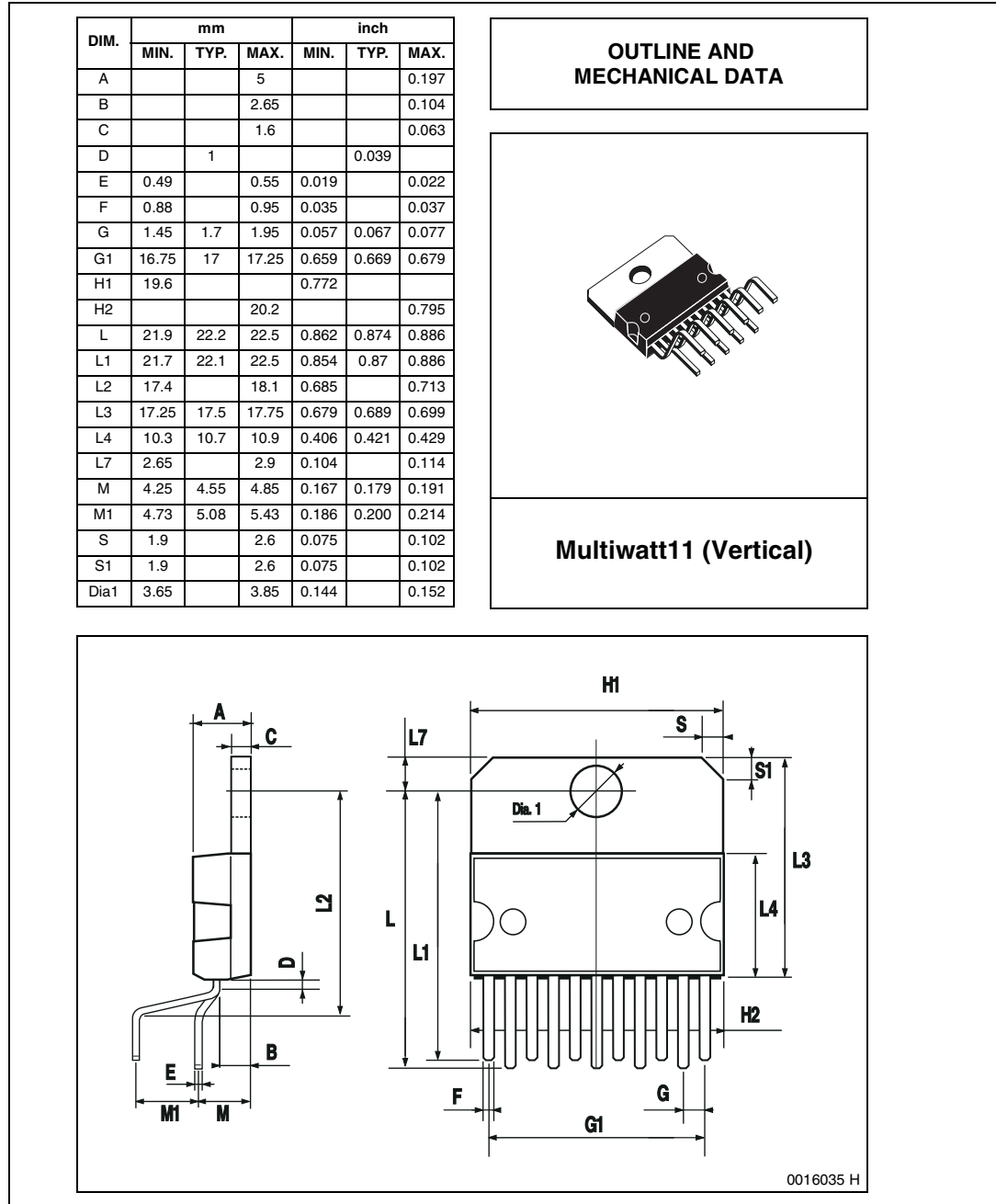

In order to meet environmental requirements, ST offers these devices in different grades of ECOPACK[®] packages, depending on their level of environmental compliance. ECOPACK[®] specifications, grade definitions and product status are available at: www.st.com. ECOPACK[®] is an ST trademark.

7 Revision history

Table 7. Document revision history

| Date | Revision | Changes |
|-------------|----------|--|
| Nov-2004 | 1 | Initial release. |
| Oct-2005 | 2 | Inserted PC board and graphics. |
| Mar-2006 | 3 | Ouput peak current changed. |
| 29-May-2009 | 4 | Updated resistor value setting mute voltage in Figure 1 on page 1 and Table 5 on page 13 . |
| 29-Feb-2012 | 5 | Added Note: on page 16 and Note: on page 18 concerning PCB layout for pin-to-pin compatible devices. |

Please Read Carefully:

Information in this document is provided solely in connection with ST products. STMicroelectronics NV and its subsidiaries ("ST") reserve the right to make changes, corrections, modifications or improvements, to this document, and the products and services described herein at any time, without notice.

All ST products are sold pursuant to ST's terms and conditions of sale.

Purchasers are solely responsible for the choice, selection and use of the ST products and services described herein, and ST assumes no liability whatsoever relating to the choice, selection or use of the ST products and services described herein.

No license, express or implied, by estoppel or otherwise, to any intellectual property rights is granted under this document. If any part of this document refers to any third party products or services it shall not be deemed a license grant by ST for the use of such third party products or services, or any intellectual property contained therein or considered as a warranty covering the use in any manner whatsoever of such third party products or services or any intellectual property contained therein.

UNLESS OTHERWISE SET FORTH IN ST'S TERMS AND CONDITIONS OF SALE ST DISCLAIMS ANY EXPRESS OR IMPLIED WARRANTY WITH RESPECT TO THE USE AND/OR SALE OF ST PRODUCTS INCLUDING WITHOUT LIMITATION IMPLIED WARRANTIES OF MERCHANTABILITY, FITNESS FOR A PARTICULAR PURPOSE (AND THEIR EQUIVALENTS UNDER THE LAWS OF ANY JURISDICTION), OR INFRINGEMENT OF ANY PATENT, COPYRIGHT OR OTHER INTELLECTUAL PROPERTY RIGHT.

UNLESS EXPRESSLY APPROVED IN WRITING BY TWO AUTHORIZED ST REPRESENTATIVES, ST PRODUCTS ARE NOT RECOMMENDED, AUTHORIZED OR WARRANTED FOR USE IN MILITARY, AIR CRAFT, SPACE, LIFE SAVING, OR LIFE SUSTAINING APPLICATIONS, NOR IN PRODUCTS OR SYSTEMS WHERE FAILURE OR MALFUNCTION MAY RESULT IN PERSONAL INJURY, DEATH, OR SEVERE PROPERTY OR ENVIRONMENTAL DAMAGE. ST PRODUCTS WHICH ARE NOT SPECIFIED AS "AUTOMOTIVE GRADE" MAY ONLY BE USED IN AUTOMOTIVE APPLICATIONS AT USER'S OWN RISK.

Resale of ST products with provisions different from the statements and/or technical features set forth in this document shall immediately void any warranty granted by ST for the ST product or service described herein and shall not create or extend in any manner whatsoever, any liability of ST.

ST and the ST logo are trademarks or registered trademarks of ST in various countries.

Information in this document supersedes and replaces all information previously supplied.

The ST logo is a registered trademark of STMicroelectronics. All other names are the property of their respective owners.

© 2012 STMicroelectronics - All rights reserved

STMicroelectronics group of companies

Australia - Belgium - Brazil - Canada - China - Czech Republic - Finland - France - Germany - Hong Kong - India - Israel - Italy - Japan - Malaysia - Malta - Morocco - Philippines - Singapore - Spain - Sweden - Switzerland - United Kingdom - United States of America

www.st.com