

Mixed Domain Oscilloscopes

MDO3000 Series Datasheet



Today's integrated designs need an oscilloscope that is just as integrated - such as the MDO3000 Mixed Domain Oscilloscope (MDO) Series. It is the ultimate 6-in-1 integrated oscilloscope that includes an integrated spectrum analyzer, arbitrary function generator, logic analyzer, protocol analyzer, and digital voltmeter/counter. The MDO3000 is completely customizable and fully upgradeable. Add the instruments and performance you need now - or later.

Key performance specifications

- Oscilloscope
 - 2 and 4 analog channel models
 - 1 GHz, 500 MHz, 350 MHz, 200 MHz, 100 MHz bandwidth models
 - Bandwidth is upgradeable (up to 1 GHz)
 - Up to 5 GS/s sample rate
 - 10 M record length on all channels
 - >280,000 wfms maximum waveform capture rate
 - Standard passive voltage probes with 3.9 pF capacitive loading and 1 GHz, 500 MHz, or 250 MHz analog bandwidth
- Spectrum Analyzer
 - Frequency range
 - Standard: 9 kHz - oscilloscope bandwidth
 - Optional: 9 kHz - 3 GHz
 - Ultra-wide capture bandwidth up to 3 GHz
- Arbitrary Function Generator (Optional)
 - 13 predefined waveform types
 - 50 MHz waveform generation
 - 128 k arbitrary generator record length
 - 250 MS/s arbitrary generator sample rate
- Logic Analyzer (Optional)
 - 16 digital channels
 - 10 M record length on all channels
 - 121.2 ps timing resolution
- Protocol Analyzer (Optional)
 - Serial bus support for I²C, SPI, RS-232/422/485/UART, USB 2.0, CAN, LIN, FlexRay, MIL-STD-1553, and Audio standards
- Digital Voltmeter (Free with product registration)
 - 4-digit AC RMS, DC, and AC+DC RMS voltage measurements
 - 5-digit frequency measurements

Key features

- FastAcq™ high-speed waveform capture rate finds elusive signal anomalies quickly
- Wave Inspector® Controls provide easy navigation and automated search of waveform data
- 33 automated measurements and waveform histograms for simplified waveform analysis
- TekVPI® probe interface directly supports active, differential, and current probes for automatic scaling and units
- 9 in. (229 mm) WVGA widescreen color display
- Small footprint and lightweight – Only 5.8 in. (147 mm) deep and 9.2 lb. (4.2 kg)
- Spectral Analysis
 - Dedicated front-panel controls for commonly performed tasks
 - Automated peak markers identify frequency and amplitude of spectrum peaks
 - Manual markers enable non-peak measurements
 - Trace types include: Normal, Average, Max Hold, and Min Hold
 - Spectrogram display enables easy observation and insight into slowly changing RF phenomena
 - Automated measurements include: Channel Power, Adjacent Channel Power Ratio (ACPR), and Occupied Bandwidth (OBW)
- Arbitrary Function Generation
 - Generate predefined signals to quickly simulate missing devices in designs
 - Capture signals on analog or digital inputs, transfer to the arbitrary edit memory, and replicate out from the AFG
 - Add noise to any signal to easily perform margin testing

- Mixed signal design and analysis
 - Automated triggering, decode, and search on parallel buses
 - Multichannel setup and hold triggering
 - MagniVu™ high-speed acquisition provides 121.2 ps fine timing resolution on digital channels
- Protocol Analysis
 - Trigger, decode and automatically search on packet-level content on most common embedded design serial bus standards.
 - Export protocol decode tables for use in documenting results
- Digital Voltmeter and Frequency Counter
 - Quickly validate voltage or frequency measurements at a glance
 - Graphical readout provides information on stability of the measurement
- Fully upgradeable
 - Add functionality, increase bandwidth or spectrum analyzer frequency range over time as your needs change or budget allows

Optional application support

- Power analysis
- Limit and mask testing

Need more performance?

Need more input frequency range on the spectrum analyzer?

Need to analyze analog, digital, and RF simultaneously?

Need more record length or a larger display?

Consider the MDO4000B Series oscilloscopes www.tektronix.com/MDO4000



- ▶ 3 GHz and 6 GHz integrated spectrum analyzers
- ▶ Simultaneous acquisition of analog, digital and RF
- ▶ 20 M record length
- ▶ 10.4 inch XGA display

Oscilloscope

At the core of the MDO3000 Series is a world-class oscilloscope, offering comprehensive tools that speed each stage of debug – from quickly discovering anomalies and capturing them, to searching your waveform record for events of interest and analyzing their characteristics and your device's behavior.

Digital phosphor technology with FastAcq™ high-speed waveform capture

To debug a design problem, first you must know it exists. Every design engineer spends time looking for problems in their design, a time-consuming and frustrating task without the right debug tools.

Digital phosphor technology provides you with fast insight into the real operation of your device. Its fast waveform capture rate – greater than 280,000 wfms/s with FastAcq – gives you a high probability of quickly seeing the infrequent problems common in digital systems: runt pulses, glitches, timing issues, and more.

To further enhance the visibility of rarely occurring events, intensity grading is used to indicate how often rare transients are occurring relative to normal signal characteristics. There are four waveform palettes available in FastAcq acquisition mode.

- The *Temperature palette* uses color-grading to indicate frequency of occurrence with hot colors like red/yellow indicating frequently occurring events and colder colors like blue/green indicating rarely occurring events.
- The *Spectral palette* uses color-grading to indicate frequency of occurrence with colder colors like blue indicating frequently occurring events and hot colors like red indicating rarely occurring events.
- The *Normal palette* uses the default channel color (like yellow for channel one) along with gray-scale to indicate frequency of occurrence where frequently occurring events are bright.
- The *Inverted palette* uses the default channel color along with gray-scale to indicate frequency of occurrence where rarely occurring events are bright.

These color palettes quickly highlight the events that over time occur more often or, in the case of infrequent anomalies, occur less often.

Infinite or variable persistence choices determine how long waveforms stay on the display, helping you to determine how often an anomaly is occurring.

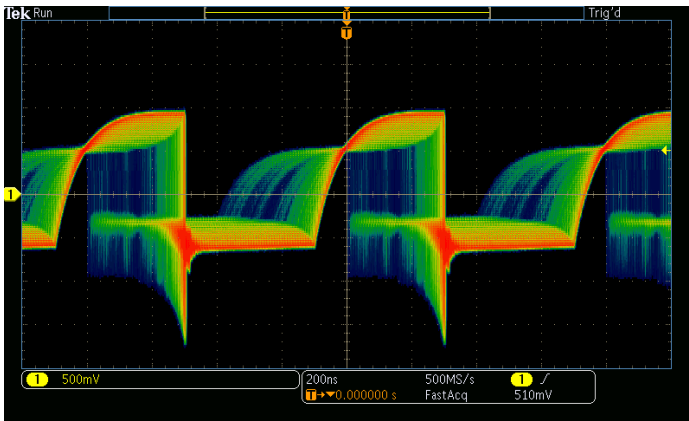

Digital phosphor technology with FastAcq enables greater than 280,000 wfms/s waveform capture rate and real-time color-intensity grading.

Triggering

Discovering a device fault is only the first step. Next, you must capture the event of interest to identify root cause. To enable this, the MDO3000 contains over 125 trigger combinations providing a complete set of triggers - including runt, logic, pulse width/glitch, setup and hold violation, serial packet, and parallel data - to help quickly locate your event of interest. And with up to a 10 M record length, you can capture many events of interest, even thousands of serial packets, in a single acquisition for further analysis while maintaining high resolution to zoom in on fine signal details.

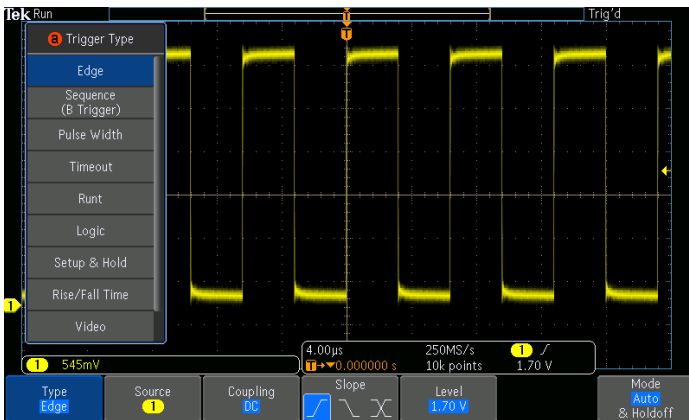

Over 125 trigger combinations make capturing your event of interest easy.

Wave Inspector® waveform navigation and automated search

With long record lengths, a single acquisition can include thousands of screens of waveform data. Wave Inspector®, the industry's best tool for waveform navigation and automated search, enables you to find events of interest in seconds.

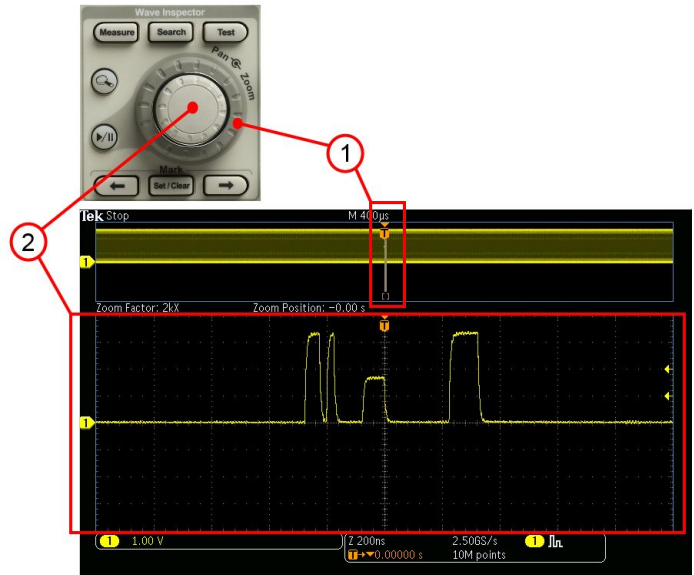

Wave Inspector controls provide unprecedented efficiency in viewing, navigating, and analyzing waveform data. Zip through your long record by turning the outer pan control (1). Get details from the beginning to end in seconds. See something of interest and want to see more details? Just turn the inner zoom control (2).

Zoom and pan

A dedicated, two-tier front-panel control provides intuitive control of both zooming and panning. The inner control adjusts the zoom factor (or zoom scale); turning it clockwise activates zoom and goes to progressively higher zoom factors, while turning it counterclockwise results in lower zoom factors and eventually turning zoom off. No longer do you need to navigate through multiple menus to adjust your zoom view. The outer control pans the zoom box across the waveform to quickly get to the portion of waveform you are interested in. The outer control also utilizes force-feedback to determine how fast to pan on the waveform. The farther you turn the outer control, the faster the zoom box moves. Pan direction is changed by simply turning the control the other way.

User marks

Press the **Set Mark** front-panel button to place one or more marks on the waveform. Navigating between marks is as simple as pressing the **Previous** (←) and **Next** (→) buttons on the front panel.

Search marks

The **Search** button allows you to automatically search through your long acquisition looking for user-defined events. All occurrences of the event are highlighted with search marks and are easily navigated to, using the front-panel **Previous** (←) and **Next** (→) buttons. Search types include edge, pulse width/glitch, timeout, runt, logic, setup and hold, rise/fall time, parallel bus, and I²C, SPI, RS-232/422/485/UART, USB 2.0, CAN, LIN, FlexRay, MIL-STD-1553, and Audio packet content. A search mark table provides a tabular view of the events found during the automated search. Each event is shown with a time stamp, making timing measurements between events easy.

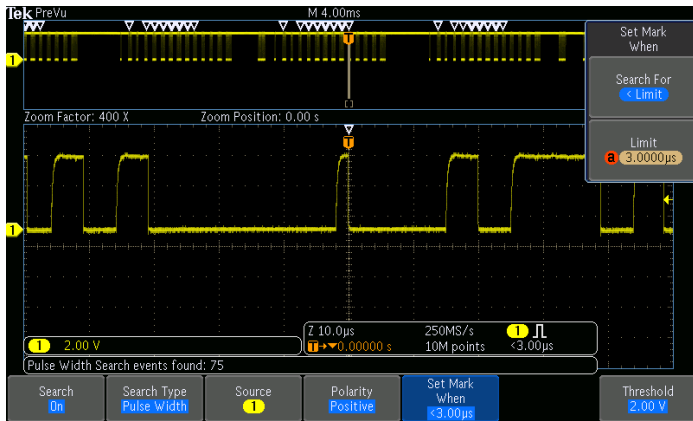

Search step 1: You define what you would like to find.

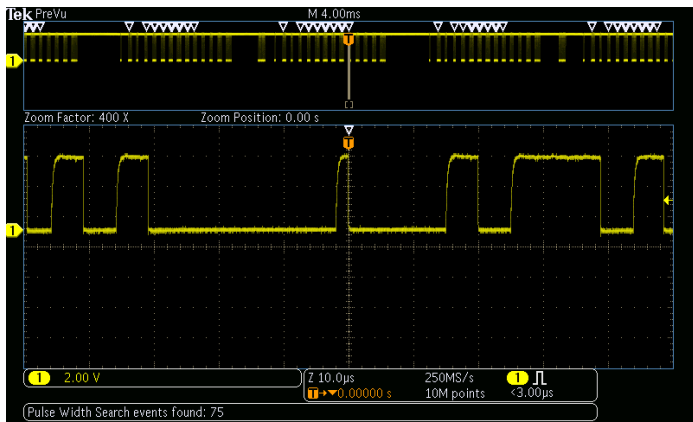

Search step 2: Wave Inspector automatically searches through the record and marks each event with a hollow white triangle. You can then use the Previous and Next buttons to jump from one event to the next.

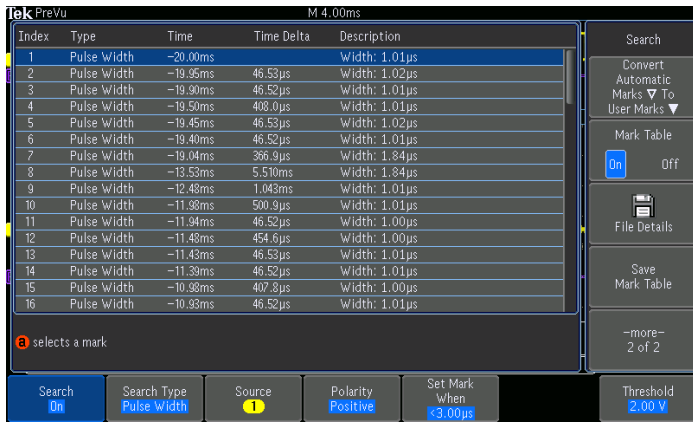

Search step 3: The Search Mark table provides a tabular view of each of the events found by the automated search. Each event is shown with a time stamp making timing measurements between events easy.

Waveform analysis

Verifying that your prototype's performance matches simulations and meets the project's design goals requires analyzing its behavior. Tasks can range from simple checks of rise times and pulse widths to sophisticated power loss analysis and investigation of noise sources.

The oscilloscope offers a comprehensive set of integrated analysis tools including waveform- and screen-based cursors, automated measurements, advanced waveform math including arbitrary equation editing, FFT analysis, waveform histograms, and trend plots for visually determining how a measurement is changing over time.

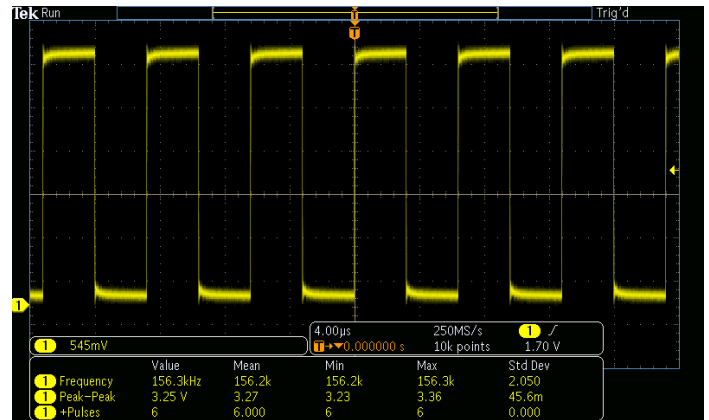

Automated measurement readouts provide repeatable, statistical views of waveform characteristics.

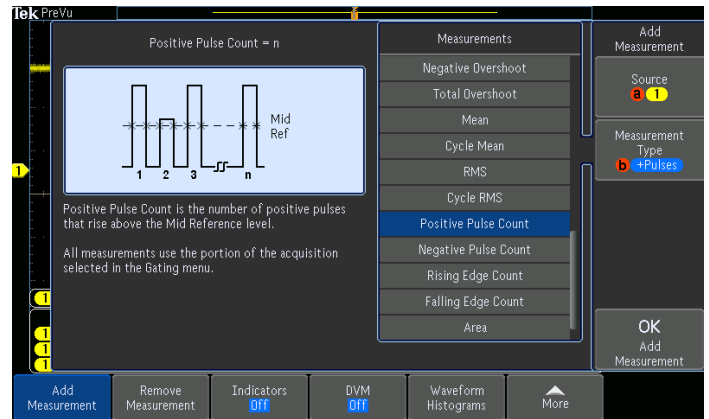

Each measurement has help text and graphics associated with it that help explain how the measurement is made.

Waveform histograms show visually how waveforms vary over time. Horizontal waveform histograms are especially useful for gaining insight into how much jitter is on a clock signal, and what the distribution of that jitter is. Vertical histograms are especially useful for gaining insight into how much noise is on a signal, and what the distribution of that noise is. Measurements taken on a waveform histogram provide analytical information about the distribution of a waveform histogram, providing insight into just how broad a distribution is, the amount of standard deviation, the mean value, etc.

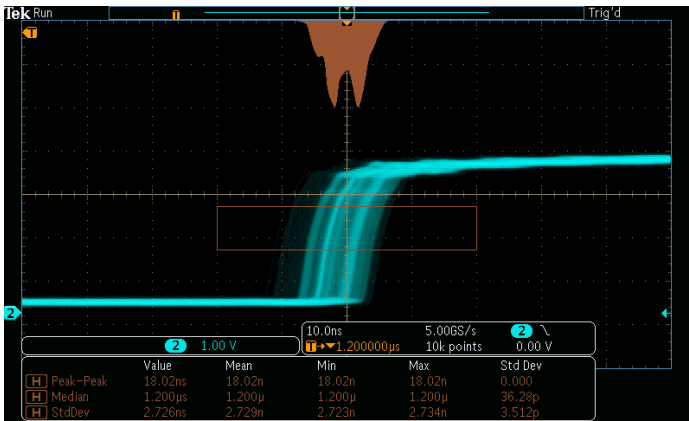

Waveform histogram of a rising edge showing the distribution of edge position (jitter) over time. Included are numeric measurements made on the waveform histogram data.

Video design and development

Many video engineers have remained loyal to analog oscilloscopes, believing the intensity gradations on an analog display are the only way to see certain video waveform details. The fast waveform capture rate of the MDO3000, coupled with its intensity-graded view of the signal, provides the same information-rich display as an analog oscilloscope, but with much more detail and all the benefits of digital scopes.

Standard features such as IRE and mV graticules, holdoff by fields, video polarity, HDTV and custom (nonstandard) video triggers, and an Autoset smart enough to detect video signals, make these the easiest to use oscilloscopes on the market for video applications. And with high bandwidth, four analog inputs, and a built-in 75 Ω input termination (not available on 1 GHz models), the oscilloscope provides ample performance for analog and digital video use. There is even a video picture mode enabling you to see the picture of the video signal you are viewing – for NTSC and PAL signals.



Viewing an NTSC video signal. Notice the intensity-graded view provided by the MDO3000's ability to represent time, amplitude, and distribution over time.



Viewing an NTSC full color bar signal image. Video picture mode contains automatic contrast and brightness settings as well as manual controls.

Power analysis (optional)

Ever increasing consumer demands for longer battery-life devices and for green solutions that consume less power require power-supply designers to characterize and minimize switching losses to improve efficiency. In addition, the supply's power levels, output purity, and harmonic feedback into the power line must be characterized to comply with national and regional power quality standards. Historically, making these and many other power measurements on an oscilloscope has been a long, manual, and tedious process. The MDO3000's optional power analysis tools greatly simplify these tasks, enabling quick, repeatable and accurate analysis of power quality, switching loss, harmonics, safe operating area (SOA), modulation, ripple, and slew rate (di/dt, dv/dt). Completely integrated into the oscilloscope, the power analysis tools provide automated, repeatable power measurements with a touch of a button.

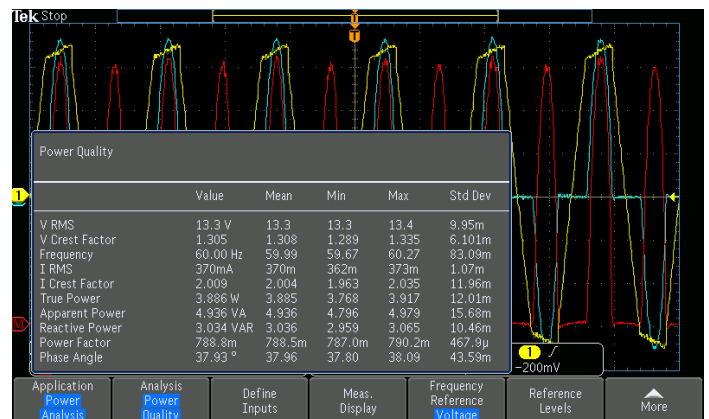

Power Quality measurement table. Automated power measurements enable quick and accurate analysis of common power parameters.

Limit/Mask testing (optional)

A common task during the development process is characterizing the behavior of certain signals in a system. One method, called limit testing, is to compare a tested signal to a known good or "golden" version of the same signal with user-defined vertical and horizontal tolerances. Another common method, called mask testing, is to compare a tested signal to a mask, looking for where a signal under test violates the mask. The MDO3000 Series offers both limit and mask testing capability useful for long-term signal monitoring, characterizing signals during design, or testing on a production line. Tailor a test to your specific requirements by defining test duration in number of waveforms or time, a violation threshold that must be met before considering a test a failure, counting hits along with statistical information, and actions upon violations, test failure, and test complete. Whether specifying a mask from a known good signal or from a custom mask, conducting pass/fail tests in search of waveform anomalies such as glitches has never been easier.

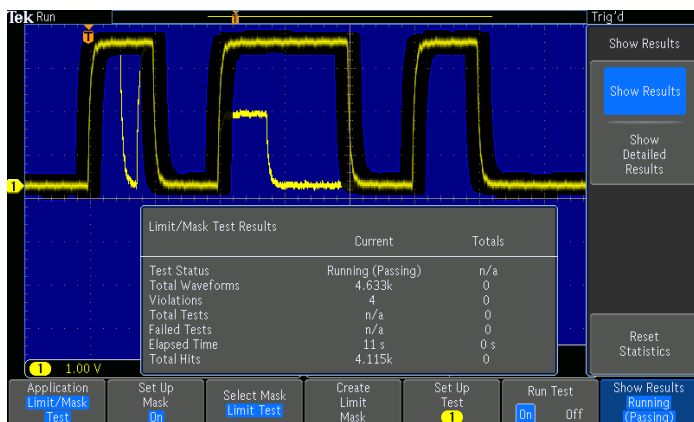

Limit Test showing a mask created from a golden waveform and compared against a live signal. Results showing statistical information about the test are displayed.

Standard passive voltage probes

The MDO3000 Series include passive voltage probes with industry best capacitive loading of only 3.9 pF. The included TPP probes minimize the impact on devices under test and accurately deliver signals to the oscilloscope for acquisition and analysis. The following table shows which TPP probes come standard with each MDO3000 model.

MDO3000 model	Included probe
MDO3012, MDO3014, MDO3022, MDO3024	TPP0250: 250 MHz, 10x passive voltage probe. One per analog channel
MDO3032, MDO3034, MDO3052, MDO3054	TPP0500B: 500 MHz, 10x passive voltage probe. One per analog channel
MDO3102, MDO3104	TPP1000: 1 GHz, 10x passive voltage probe. One per analog channel

TekVPI® probe interface

The TekVPI probe interface sets the standard for ease of use in probing. In addition to the secure, reliable connection that the interface provides, TekVPI probes feature status indicators and controls, as well as a probe menu button right on the comp box itself. This button brings up a probe menu on the oscilloscope display with all relevant settings and controls for the probe. The TekVPI interface enables direct attachment of current probes without requiring a separate power supply. TekVPI probes can be controlled remotely through USB, GPIB, or LAN, enabling more versatile solutions in ATE environments. The TekVPI inputs provide up to 25 W of power to the front panel connectors from the internal power supply.



TekVPI probe interface simplifies connecting your probes to the oscilloscope.

Remote connectivity and instrument control

Exporting data and measurements is as simple as connecting a USB cable from the oscilloscope to your PC. Key software applications – OpenChoice® Desktop, and Microsoft Excel and Word toolbars – are included standard with each oscilloscope to enable fast and easy direct communication with your Windows PC.

The included OpenChoice Desktop enables fast and easy communication between the oscilloscope and your PC through USB or LAN for transferring settings, waveforms, and screen images.

The embedded e*Scope® capability enables fast control of the oscilloscope over a network connection through a standard web browser. Simply enter the IP address or network name of the oscilloscope and a web page will be served to the browser. Transfer and save settings, waveforms, measurements, and screen images or make live control changes to settings on the oscilloscope directly from the web browser.



e*Scope in a web browser showing the display of an MDO3000. Use e*Scope to quickly document your work by saving screen images, waveforms, or setups for later use.

Spectrum Analyzer

The MDO3000 is the first oscilloscope in its class to include an integrated spectrum analyzer. Each oscilloscope includes a spectrum analyzer with a frequency range of 9 kHz up to the analog bandwidth of the instrument. The spectrum analyzer frequency range of each instrument can be upgraded from 9 kHz to 3 GHz (option MDO3SA), enabling spectral analysis on most consumer wireless standards.

Fast and accurate spectral analysis

When using the spectrum analyzer input, the MDO3000 Series display becomes a full-screen Frequency Domain view.

Key spectral parameters such as Center Frequency, Span, Reference Level, and Resolution Bandwidth are all adjusted quickly and easily using the dedicated front-panel menus and keypad.

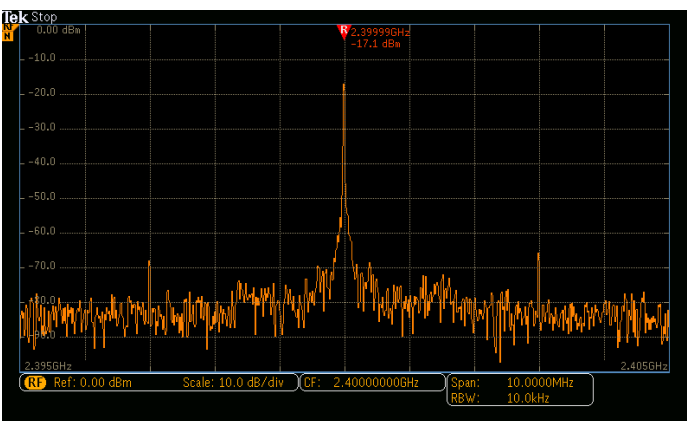

MDO3000 frequency domain display.



Key spectral parameters are adjusted quickly with the dedicated front-panel menus and keypad.

Intelligent, efficient markers

In a traditional spectrum analyzer, it can be a very tedious task to turn on and place enough markers to identify all your peaks of interest. The MDO3000 Series makes this process far more efficient by automatically placing markers on peaks that indicate both the frequency and the amplitude of each peak. You can adjust the criteria that the oscilloscope uses to automatically find the peaks.

The highest amplitude peak is referred to as the reference marker and is shown in red. Marker readouts can be switched between Absolute and Delta readouts. When Delta is selected, marker readouts show each peak's delta frequency and delta amplitude from the reference marker.

Two manual markers are also available for measuring non-peak portions of the spectrum. When enabled, the reference marker is attached to one of the manual markers, enabling delta measurements from anywhere in the spectrum. In addition to frequency and amplitude, manual marker readouts also include noise density and phase noise readouts depending on whether Absolute or Delta readouts are selected. A "Reference Marker to Center" function instantly moves the frequency indicated by the reference marker to center frequency.

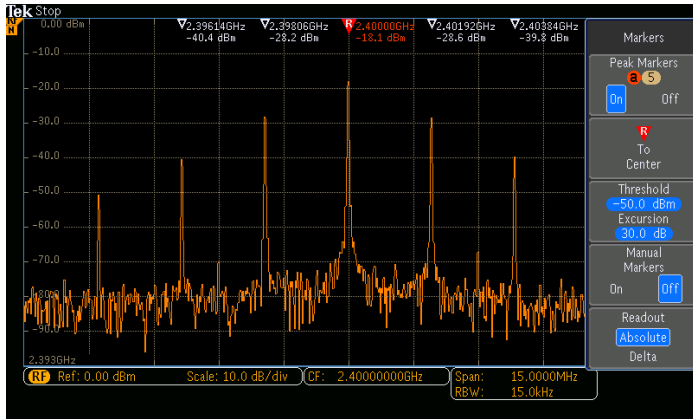

Automated peak markers identify critical information at a glance. As shown here, the five highest amplitude peaks that meet the threshold and excursion criteria are automatically marked along with the peak's frequency and amplitude.

Spectrogram

The MDO3000 Series includes a spectrogram display which is ideal for monitoring slowly changing RF phenomena. The x-axis represents frequency, just like a typical spectrum display. However, the y-axis represents time, and color is used to indicate amplitude.

Spectrogram slices are generated by taking each spectrum and "flipping it up on its edge" so that it's one pixel row tall, and then assigning colors to each pixel based on the amplitude at that frequency. Cold colors (blue, green) are low amplitude and hotter colors (yellow, red) are higher amplitude. Each new acquisition adds another slice at the bottom of the spectrogram and the history moves up one row. When acquisitions are stopped, you can scroll back through the spectrogram to look at any individual spectrum slice.

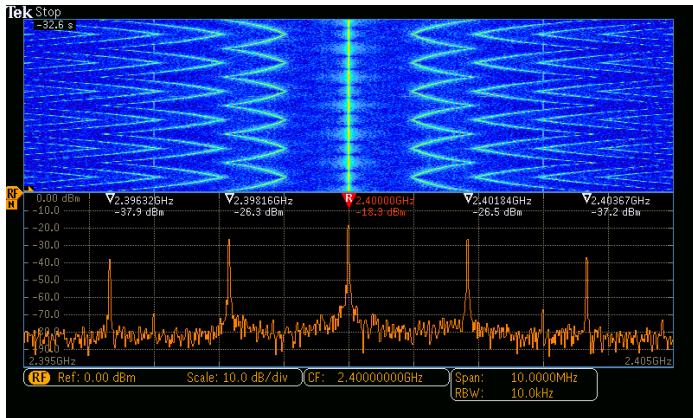

Spectrogram display illustrates slowly moving RF phenomena. As shown here, a signal that has multiple peaks is being monitored. As the peaks change in both frequency and amplitude over time, the changes are easily seen in the Spectrogram display.

Ultra-wide capture bandwidth

Today's wireless communications vary significantly with time, using sophisticated digital modulation schemes and, often, transmission techniques that involve bursting the output. These modulation schemes can have very wide bandwidth as well. Traditional swept or stepped spectrum analyzers are ill equipped to view these types of signals as they are only able to look at a small portion of the spectrum at any one time.

The amount of spectrum acquired in one acquisition is called the capture bandwidth. Traditional spectrum analyzers sweep or step the capture bandwidth through the desired span to build the requested image. As a result, while the spectrum analyzer is acquiring one portion of the spectrum, the event you care about may be happening in another portion of the spectrum. Most spectrum analyzers on the market today have 10 MHz capture bandwidths, sometimes with expensive options to extend that to 20, 40, or even 160 MHz in some cases.

In order to address the bandwidth requirements of modern RF, the MDO3000 Series provides up to 3 GHz of capture bandwidth. The spectrum is generated from a single acquisition, thus guaranteeing you'll see the events you're looking for in the frequency domain.

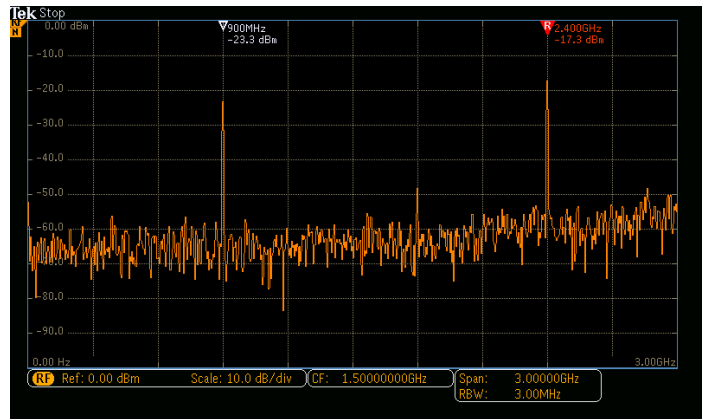

Spectral display of a bursted communication both into a device through Zigbee at 900 MHz and out of the device through Bluetooth at 2.4 GHz, captured with a single acquisition.

Spectrum traces

The MDO3000 Series spectrum analyzer offers four different traces or views including Normal, Average, Max Hold, and Min Hold.

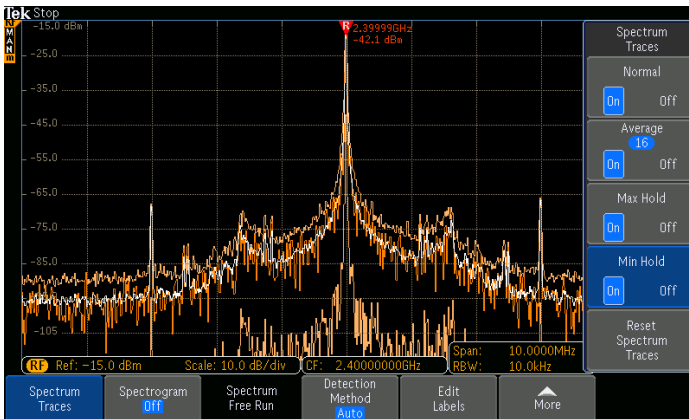

Normal, Average, Max Hold, and Min Hold spectrum traces

RF measurements

The MDO3000 Series includes three automated RF measurements - Channel Power, Adjacent Channel Power Ratio, and Occupied Bandwidth. When one of these RF measurements is activated, the oscilloscope automatically turns on the Average spectrum trace and sets the detection method to Average for optimal measurement results.

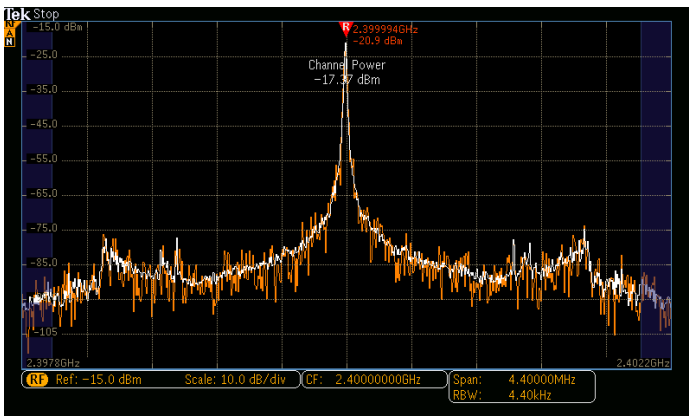

Automated Channel Power measurement

Advanced RF analysis

The MDO3000 can save the baseband I and Q data from spectrum analyzer acquisitions to a .TIQ file. These files can then be imported into Tektronix SignalVu-PC software for general purpose modulation and pulse analysis or RSAVu for analysis of commercial wireless standards.

RF probing

Signal input methods on spectrum analyzers are typically limited to cabled connections or antennas. But with the optional TPA-N-VPI adapter, any active, 50 Ω TekVPI probe can be used with the spectrum analyzer on the MDO3000 Series. This enables additional flexibility when hunting for noise sources and enables easier spectral analysis by using true signal browsing on a spectrum analyzer input.

In addition, an optional preamplifier accessory assists in the investigation of lower-amplitude signals. The TPA-N-PRE preamplifier provides 10 dB nominal gain across the 9 kHz – 3 GHz frequency range.



The optional TPA-N-VPI adapter enables any active, 50 Ω TekVPI probe to be connected to the RF input.

Arbitrary Function Generator (optional)

The MDO3000 contains an optional integrated arbitrary function generator (option MDO3AFG), perfect for simulating sensor signals within a design or adding noise to signals to perform margin testing.

The integrated function generator provides output of predefined waveforms up to 50 MHz for sine, square, pulse, ramp/triangle, DC, noise, $\sin(x)/x$ (Sinc), Gaussian, Lorentz, exponential rise/fall, Haversine and cardiac.

The arbitrary waveform generator provides 128 k points of record for storing waveforms from the analog input, a saved internal file location, a USB mass storage device, or from an external PC. Once a waveform is in the edit memory of the arbitrary waveform generator, it can be modified via an on-screen editor and then replicated out of the generator. The MDO3000 is compatible with Tektronix' ArbExpress PC-based waveform creation and editing software, making creation of complex waveforms fast and easy. Transfer waveform files to your MDO3000 edit memory via USB or LAN or using a USB mass storage device to be output from the AFG in the oscilloscope.

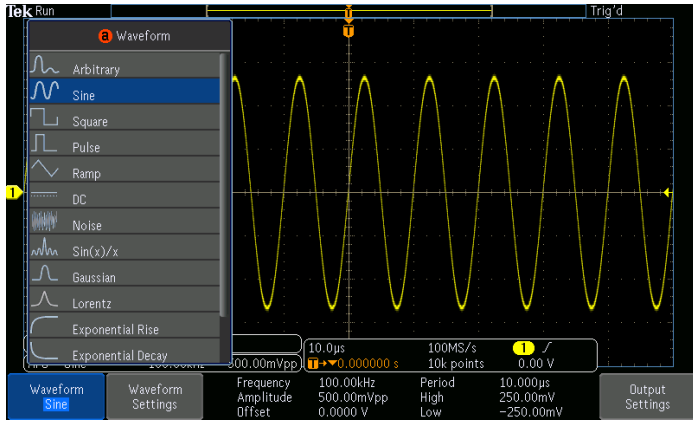

Waveform type selection in the integrated AFG.

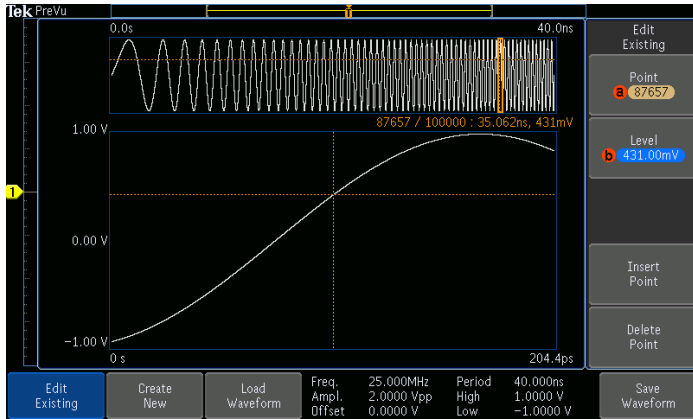

Arbitrary waveform editor showing the point-by-point editor.

Logic Analyzer (optional)

The logic analyzer (option MDO3MSO) provides 16 digital channels which are tightly integrated into the oscilloscope's user interface. This simplifies operation and makes it possible to solve mixed-signal issues easily.



The MDO3000 with MDO3MSO option provides 16 integrated digital channels enabling you to view and analyze time-correlated analog and digital signals.

Color-coded digital waveform display

Color-coded digital traces display ones in green and zeros in blue. This coloring is also used in the digital channel monitor. The monitor shows if signals are high, low, or are transitioning so you can see channel activity at a glance without having to clutter your display with unneeded digital waveforms.

The multiple transition detection hardware shows you a white edge on the display when the system detects multiple transitions. White edges indicate that more information is available by zooming in or acquiring at faster sampling rates. In most cases zooming in will reveal the pulse that was not viewable with the previous settings. If the white edge is still present after zooming in as far as possible, this indicates that increasing the sample rate on the next acquisition will reveal higher frequency information than the previous settings could acquire.

You can group digital waveforms and enter waveform labels by using a USB keyboard. By simply placing digital waveforms next to each other, they form a group.

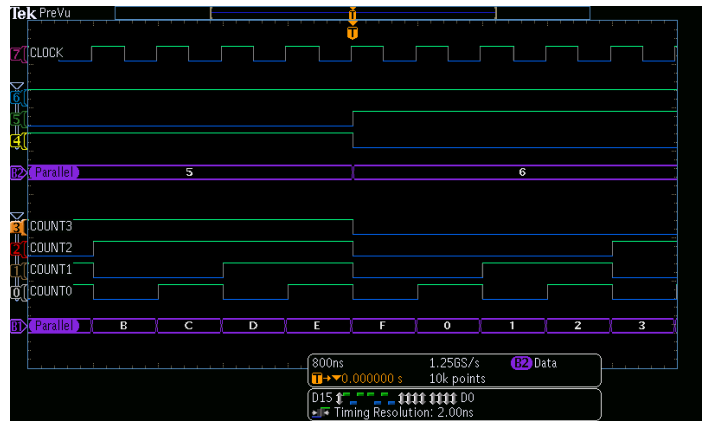

With color-coded digital waveform display, groups are created by simply placing digital channels together on the screen, allowing digital channels to be moved as a group.

Once a group is formed, you can position all the channels contained in that group collectively. This greatly reduces the normal setup time associated with positioning channels individually.

MagniVu™ high-speed acquisition

The main digital acquisition mode on the MDO3000 Series will capture up to 10 M at 500 MS/s (2 ns resolution). In addition to the main record, the MDO3000 provides an ultra high-resolution record called MagniVu which acquires 10,000 points at up to 8.25 GS/s (121.2 ps resolution). Both main and MagniVu waveforms are acquired on every trigger and can be switched between in the display at any time, running or stopped. MagniVu provides significantly finer timing resolution than comparable oscilloscopes on the market, instilling confidence when making critical timing measurements on digital waveforms.



The MagniVu high-resolution record provides 121.2 ps timing resolution, enabling you to take critical timing measurements on your digital waveforms.

P6316 MSO probe

This unique probe design offers two eight-channel pods, simplifying the process of connecting to the device-under-test. When connecting to square pins, the P6316 can connect directly to 8×2 square pin headers spaced on tenth-inch centers. When more attachment flexibility is required, you can use the included flying lead sets and grabbers to clip onto surface mount devices or test points. The P6316 offers outstanding electrical characteristics applying only 8 pF of capacitive loading with 101 kΩ input impedance.



The P6316 MSO probe offers two eight-channel pods to simplify connecting to your device.

Serial Protocol Triggering and Analysis (optional)

On a serial bus, a single signal often includes address, control, data, and clock information. This can make isolating events of interest difficult. Automatic trigger, decode, and search on bus events and conditions gives you a robust set of tools for debugging serial buses.

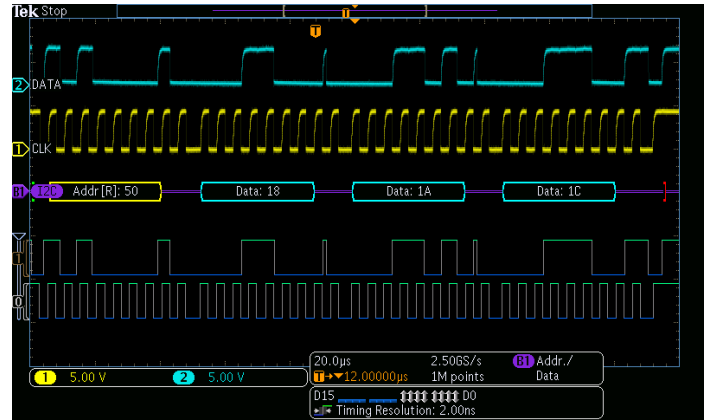

Triggering on a specific address and data packet going across an I²C bus. The yellow waveform is clock and the blue waveform is the data. A bus waveform provides decoded packet content including Start, Address, Read/Write, Data, and Stop.

Serial triggering

Trigger on packet content such as start of packet, specific addresses, specific data content, unique identifiers, etc. on popular serial interfaces such as I²C, SPI, RS-232/422/485/UART, USB2.0, CAN, LIN, FlexRay, MIL-STD-1553, and I²S/LJ/RJ/TDM.

Bus display

Provides a higher-level, combined view of the individual signals (clock, data, chip enable, etc.) that make up your bus, making it easy to identify where packets begin and end and identifying sub-packet components such as address, data, identifier, CRC, etc.

Bus decoding

Tired of having to visually inspect the waveform to count clocks, determine if each bit is a 1 or a 0, combine bits into bytes, and determine the hex value? Let the oscilloscope do it for you! Once you've set up a bus, the MDO3000 Series will decode each packet on the bus, and display the value in hex, binary, decimal (USB, LIN, FlexRay, and MIL-STD-1553 only), signed decimal (I²S/LJ/RJ/TDM only), or ASCII (USB, MIL-STD-1553 and RS-232/422/485/UART only) in the bus waveform.

Serial bus technologies supported by the MDO3000

Technology		Trigger, Decode, Search	Order product
Embedded	I ² C	Yes	MDO3EMBD
	SPI	Yes	MDO3EMBD
Computer	RS232/422/485, UART	Yes	MDO3COMP
USB	USB LS, FS, HS	Yes (trigger on LS and FS only; HS decode only on 1 GHz models)	MDO3USB
Automotive	CAN	Yes	MDO3AUTO
	LIN	Yes	MDO3AUTO
	FlexRay	Yes	MDO3FLEX
Military and aerospace	MIL-STD-1553	Yes	MDO3AERO
Audio	I ² S	Yes	MDO3AUDIO
	LJ, RJ	Yes	MDO3AUDIO
	TDM	Yes	MDO3AUDIO

Event table

In addition to seeing decoded packet data on the bus waveform itself, you can view all captured packets in a tabular view much like you would see in a software listing. Packets are time stamped and listed consecutively with columns for each component (Address, Data, etc.). You can save the event table data in .CSV format.



Event table showing decoded identifier, DLC, DATA, and CRC for every CAN packet in a long acquisition.

Search (serial triggering)

Serial triggering is very useful for isolating the event of interest, but once you've captured it and need to analyze the surrounding data, what do you do? In the past, users had to manually scroll through the waveform counting and converting bits and looking for what caused the event. You can have the oscilloscope automatically search through the acquired data for user-defined criteria including serial packet content. Each occurrence is highlighted by a search mark. Rapid navigation between marks is as simple as pressing the **Previous** (←) and **Next** (→) buttons on the front panel.

Digital Voltmeter (DVM) and Frequency Counter

The MDO3000 contains an integrated 4-digit digital voltmeter (DVM) and 5-digit frequency counter. Any of the analog inputs can be a source for the voltmeter, using the same probes that are already attached for general oscilloscope usage. The easy-to-read display offers you both numeric and graphical representations of the changing measurement values. The display also shows minimum, maximum, and average values of the measurement as well as the range of values measured over the previous five second interval. The DVM and frequency counter is available on any MDO3000 and is activated when you register your product.

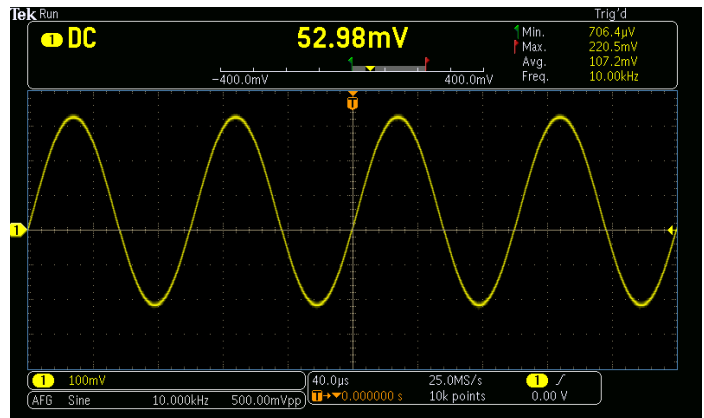

A DC measurement value is shown with a five second variation along with minimum, maximum, and average voltage values. The frequency of the waveform is also shown.

Designed to fit into your work environment



The MDO3000 is designed to fit into your work environment. With six instruments in one small, portable package, the MDO3000 offers a unique combination of debug tools without taking up valuable space on your bench.

Large high-resolution display

The MDO3000 Series features a 9 inch (229 mm) wide-screen, high-resolution (800 × 480 WVGA) display for seeing intricate signal details.

Connectivity

The MDO3000 contains a number of ports which can be used to connect the instrument to a network, directly to a PC, or other test equipment.

- Front and rear USB host ports enable easy transfer of screen shots, instrument settings, and waveform data to a USB mass storage device. A USB keyboard can also be attached to a USB host port for data entry.
- Rear USB device port is useful for controlling the oscilloscope remotely from a PC or for printing directly to a PictBridge®-compatible printer.
- The standard 10/100 Ethernet port on the rear of the instrument enables easy connection to networks, provides network and e-mail printing, and provides LXI Core 2011 compatibility.
- A video out port on the rear of the instrument allows the display to be exported to an external monitor or projector.

Compact form factor

With the compact, portable form factor, you can easily move the oscilloscope between labs. And with a depth of just 5.8 inches (147 mm), it saves you valuable space on your test bench. The MDO3000 has all the tools you'll need for everyday debug tasks, all in a single instrument.



The MDO3000 Series compact form factor frees up valuable space on your bench or desktop while making sure you will always have the debug tools you need.

Specifications

All specifications apply to all models unless noted otherwise.

	MDO3012	MDO3014	MDO3022	MDO3024	MDO3032	MDO3034	MDO3052	MDO3054	MDO3102	MDO3104
Analog channels	2	4	2	4	2	4	2	4	2	4
Analog channel bandwidth	100 MHz	100 MHz	200 MHz	200 MHz	350 MHz	350 MHz	500 MHz	500 MHz	1 GHz	1 GHz
Rise time (10 mV/div setting with 50Ω input termination)	4 ns	4 ns	2 ns	2 ns	1.14 ns	1.14 ns	800 ps	800 ps	400 ps	400 ps
Sample rate (1 ch)	2.5 GS/s	2.5 GS/s	2.5 GS/s	2.5 GS/s	2.5 GS/s	2.5 GS/s	2.5 GS/s	2.5 GS/s	5 GS/s	5 GS/s
Sample rate (2 ch)	2.5 GS/s	2.5 GS/s	2.5 GS/s	2.5 GS/s	2.5 GS/s	2.5 GS/s	2.5 GS/s	2.5 GS/s	5 GS/s	5 GS/s
Sample rate (4 ch)	-	2.5 GS/s	-	2.5 GS/s	-	2.5 GS/s	-	2.5 GS/s	-	2.5 GS/s
Record length (1 ch)	10 M	10 M	10 M	10 M	10 M	10 M	10 M	10 M	10 M	10 M
Record length (2 ch)	10 M	10 M	10 M	10 M	10 M	10 M	10 M	10 M	10 M	10 M
Record length (4 ch)	-	10 M	-	10 M	-	10 M	-	10 M	-	10 M
Digital channels with MDO3MSO option	16	16	16	16	16	16	16	16	16	16
Arbitrary Function Generator outputs with MDO3AFG option	1	1	1	1	1	1	1	1	1	1
Spectrum analyzer channels	1	1	1	1	1	1	1	1	1	1
Standard spectrum analyzer frequency range	9 kHz - 100 MHz	9 kHz - 100 MHz	9 kHz - 200 MHz	9 kHz - 200 MHz	9 kHz - 350 MHz	9 kHz - 350 MHz	9 kHz - 500 MHz	9 kHz - 500 MHz	9 kHz - 1 GHz	9 kHz - 1 GHz
Optional spectrum analyzer frequency range with MDO3SA option	9 kHz - 3 GHz	9 kHz - 3 GHz	9 kHz - 3 GHz	9 kHz - 3 GHz	9 kHz - 3 GHz	9 kHz - 3 GHz	9 kHz - 3 GHz	9 kHz - 3 GHz	9 kHz - 3 GHz	9 kHz - 3 GHz

Vertical system analog channels

Hardware bandwidth limits

≥350 MHz models	20 MHz or 250 MHz
100 MHz and 200 MHz models	20 MHz

Input coupling AC, DC

Input impedance 1 MΩ ±1%, 50 Ω ±1%, 75 Ω ±1%; 75 Ω not available on 1 GHz models

Input sensitivity range

1 MΩ	1 mV/div to 10 V/div
50 Ω, 75 Ω	1 mV/div to 1 V/div

Vertical resolution 8 bits (11 bits with Hi Res)

Maximum input voltage

1 MΩ	300 V _{RMS} CAT II with peaks ≤ ±425 V
50 Ω, 75 Ω	5 V _{RMS} with peaks ≤ ±20 V

Vertical system analog channels

DC gain accuracy	±1.5% for 5 mV/div and above, derated at 0.10%/°C above 30 °C
	±2.0% for 2 mV/div, derated at 0.10%/°C above 30 °C
	±2.5% for 1 mV/div, derated at 0.10%/°C above 30 °C
	±3.0% for variable gain, derated 0.10%/°C above 30 °C

Channel-to-channel isolation Any two channels at equal vertical scale $\geq 100:1$ at ≤ 100 MHz and $\geq 30:1$ at >100 MHz up to the rated bandwidth

Offset range	Volts/div setting	Offset range	
		1 M Ω input	50 Ω, 75 Ω input
	1 mV/div to 50 mV/div	±1 V	±1 V
	50.5 mV/div to 99.5 mV/div	±0.5 V	±0.5 V
	100 mV/div to 500 mV/div	±10 V	±10 V
	505 mV/div to 995 mV/div	±5 V	±5 V
	1 V/div to 5 V/div	±100 V	±5 V

Vertical system digital channels

(Requires MDO3MSO option)

Input channels	16 digital (D15 to D0)
Thresholds	Threshold per set of 8 channels
Threshold selections	TTL, CMOS, ECL, PECL, User-defined
User-defined threshold range	-15 V to +25 V
Maximum input voltage	-20 V to +30 V
Threshold accuracy	±[100 mV + 3% of threshold setting]
Input dynamic range	50 V _{p-p} (threshold setting dependent)
Minimum voltage swing	500 mV
Input resistance	101 k Ω
Probe loading	8 pF
Vertical resolution	1 bit

Horizontal system analog channels

Time base range	
1 GHz models	400 ps/div to 1000 s/div
≤ 500 MHz models	1 ns/div to 1000 s/div
Maximum duration at highest sample rate (all/half channels)	
1 GHz models	4/2 ms
≤ 500 MHz models	4/4 ms
Time-base delay time range	-10 divisions to 5000 s
Channel-to-channel deskew range	±125 ns
Time base accuracy	±10 ppm over any ≥1 ms interval

Horizontal system digital channels

(Requires MDO3MSO option)

Maximum sample rate (Main)	500 MS/s (2 ns resolution)
Maximum record length (Main)	10 M
Maximum sample rate (MagniVu)	8.25 GS/s (121.2 ps resolution)
Maximum record length (MagniVu)	10k centered on the trigger
Minimum detectable pulse width (typical)	2 ns
Channel-to-channel skew (typical)	500 ps
Maximum input toggle rate	250 MHz (Maximum frequency sine wave that can accurately be reproduced as a logic square wave. Requires the use of a short ground extender on each channel. This is the maximum frequency at the minimum swing amplitude. Higher toggle rates can be achieved with higher amplitudes.)

Spectrum analyzer input

Capture bandwidth	MDO3012, MDO3014 models: 100 MHz MDO3022, MDO3024 models: 200 MHz MDO3032, MDO3034 models: 350 MHz MDO3052, MDO3054 models: 500 MHz MDO3102, MDO3104 models: 1 GHz All models: 3 GHz with option MDO3SA
Span	MDO3012, MDO3014 models: 9 kHz – 100 MHz MDO3022, MDO3024 models: 9 kHz – 200 MHz MDO3032, MDO3034 models: 9 kHz – 350 MHz MDO3052, MDO3054 models: 9 kHz – 500 MHz MDO3102, MDO3104 models: 9 kHz – 1 GHz All models: 9 kHz – 3 GHz with option MDO3SA, in a 1-2-5 sequence

Spectrum analyzer input

Resolution bandwidth	20 Hz - 150 MHz in a 1-2-3-5 sequence
Reference level	-130 dBm to +20 dBm in steps of 5 dBm
Vertical scale	1 dB/div to 20 dB/div in a 1-2-5 sequence
Vertical position	-100 divs to +100 divs (displayed in dB)
Vertical units	dBm, dBmV, dBμV, dBμW, dBmA, dBμA
Displayed average noise level (DANL)	
9 kHz - 50 kHz	< -109 dBm/Hz (< -113 dBm/Hz typical)
50 kHz - 5 MHz	< -126 dBm/Hz (< -130 dBm/Hz typical)
5 MHz - 2 GHz	< -138 dBm/Hz (< -142 dBm/Hz typical)
2 GHz - 3 GHz	< -128 dBm/Hz (< -132 dBm/Hz typical)
DANL with TPA-N-PRE preamp attached	
9 kHz - 50 kHz	< -117 dBm/Hz (< -121 dBm/Hz typical)
50 kHz - 5 MHz	< -136 dBm/Hz (< -140 dBm/Hz typical)
5 MHz - 2 GHz	< -148 dBm/Hz (< -152 dBm/Hz typical)
2 GHz - 3 GHz	< -138 dBm/Hz (< -142 dBm/Hz typical)
Spurious response	
2 nd harmonic distortion (>100 MHz)	< -55 dBc (< -60 dBc typical)
3 rd harmonic distortion (>100MHz)	< -53 dBc (< -58 dBc typical)
2 nd order intermodulation distortion (>15 MHz)	< -55 dBc (< -60 dBc typical)
3 rd order intermodulation distortion (>15 MHz)	< -55 dBc (< -60 dBc typical)
Residual response	
	< -78 dBm (≤ -15 dBm reference level and RF input terminated with 50Ω)
At 2.5 GHz	< -67 dBm
At 1.25 GHz	< -76 dBm
Crosstalk to spectrum analyzer from oscilloscope channels	
≤800 MHz input frequencies	< -60 dB from ref level (typical)
>800 MHz - 2 GHz input frequencies	< -40 dB from ref level (typical)
Phase noise at 1 GHz CW	
10 kHz	< -81 dBc/Hz, < -85 dBc/Hz (typical)
100 kHz	< -97 dBc/Hz, < -101 dBc/Hz (typical)
1 MHz	< -118 dBc/Hz, < -122 dBc/Hz (typical)

Spectrum analyzer input

Level measurement uncertainty	Reference level 10 dBm to -15 dBm. Input level ranging from reference level to 40 dB below reference level. Specifications exclude mismatch error.														
18 °C - 28 °C	< ±1.2 dBm (< ±0.6 dBm typical)														
Over operating range	< ±2.0 dBm														
Level measurement uncertainty with TPA-N-PRE preamp attached	Preamp mode set to "Auto". Reference level 10 dBm set to -40dBm. Input level ranging from reference level to 30 dB below reference level. Specifications exclude mismatch error.														
18 °C - 28 °C	< ±1.5 dBm (typical) either preamp state														
Over operating range	< ±2.3 dBm either preamp state														
Frequency measurement accuracy	$\pm((\text{Reference Frequency Error}) \times [\text{Marker Frequency}]) + (\text{span}/750 + 2)$ Hz; Reference Frequency Error = 10ppm (10 Hz / MHz)														
Maximum operating input level															
Average continuous power	+20 dBm (0.1 W)														
DC maximum before damage	±40 V DC														
Maximum power before damage (CW)	+33 dBm (2 W)														
Maximum power before damage (pulse)	+45 dBm (32 W) (<10 µs pulse width, <1% duty cycle, and reference level of ≥ +10 dBm)														
Maximum operating input level with TPA-N-PRE preamp attached															
Average continuous power	+20 dBm (0.1 W)														
DC maximum before damage	±20 V DC														
Maximum power before damage (CW)	+30 dBm (1 W)														
Maximum power before damage (pulse)	+45 dBm (32 W) (<10 µs pulse width, <1% duty cycle, and reference level of ≥ +10 dBm)														
Frequency domain trace types	Normal, Average, Max Hold, Min Hold														
Detection methods	+Peak, -Peak, Average, Sample														
Automatic markers	One to eleven peaks identified based on user-adjustable threshold and excursion values														
Manual markers	Two manual markers indicating frequency, amplitude, noise density, and phase noise														
Marker readouts	Absolute or Delta														
FFT windows	<table border="1"> <thead> <tr> <th>FFT window</th> <th>Factor</th> </tr> </thead> <tbody> <tr> <td>Kaiser</td> <td>2.23</td> </tr> <tr> <td>Rectangular</td> <td>0.89</td> </tr> <tr> <td>Hamming</td> <td>1.30</td> </tr> <tr> <td>Hanning</td> <td>1.44</td> </tr> <tr> <td>Blackman-Harris</td> <td>1.90</td> </tr> <tr> <td>Flat-Top</td> <td>3.77</td> </tr> </tbody> </table>	FFT window	Factor	Kaiser	2.23	Rectangular	0.89	Hamming	1.30	Hanning	1.44	Blackman-Harris	1.90	Flat-Top	3.77
FFT window	Factor														
Kaiser	2.23														
Rectangular	0.89														
Hamming	1.30														
Hanning	1.44														
Blackman-Harris	1.90														
Flat-Top	3.77														

Trigger system

Trigger modes	Auto, Normal, and Single								
Trigger coupling	DC, AC, HF reject (attenuates >50 kHz), LF reject (attenuates <50 kHz), noise reject (reduces sensitivity)								
Trigger holdoff range	20 ns to 8 s								
Trigger sensitivity (typical)	Edge type, DC coupled								
	<table border="1"> <thead> <tr> <th>Trigger source</th> <th>Sensitivity</th> </tr> </thead> <tbody> <tr> <td>Any analog channel input</td> <td>For 1 mV/div to 4.98 mV/div; 0.75 div from DC to 50 MHz, increasing to 1.3 div at instrument bandwidth ≥ 5mV/div: 0.40 div from DC to 50 MHz</td> </tr> <tr> <td>Aux In (External); available on two-channel instruments only</td> <td>200 mV from DC to 50 MHz, increasing to 500 mV at 200 M</td> </tr> <tr> <td>Line</td> <td>Fixed</td> </tr> </tbody> </table>	Trigger source	Sensitivity	Any analog channel input	For 1 mV/div to 4.98 mV/div; 0.75 div from DC to 50 MHz, increasing to 1.3 div at instrument bandwidth ≥ 5mV/div: 0.40 div from DC to 50 MHz	Aux In (External); available on two-channel instruments only	200 mV from DC to 50 MHz, increasing to 500 mV at 200 M	Line	Fixed
Trigger source	Sensitivity								
Any analog channel input	For 1 mV/div to 4.98 mV/div; 0.75 div from DC to 50 MHz, increasing to 1.3 div at instrument bandwidth ≥ 5mV/div: 0.40 div from DC to 50 MHz								
Aux In (External); available on two-channel instruments only	200 mV from DC to 50 MHz, increasing to 500 mV at 200 M								
Line	Fixed								
Trigger level ranges									
Any input channel	±8 divisions from center of screen, ±8 divisions from 0 V when vertical LF reject trigger coupling is selected								
Aux In (External)	±8 V								
Line	The line trigger level is fixed at about 50% of the line voltage.								
Trigger frequency readout	Provides 6-digit frequency readout of triggerable events.								
Trigger types									
Edge	Positive, negative, or either slope on any channel. Coupling includes DC, AC, HF reject, LF reject, and noise reject.								
Sequence (B-trigger)	Trigger Delay by Time: 8 ns to 8 s. Or Trigger Delay by Events: 1 to 4,000,000 events. Not available when "Either" edge is selected.								
Pulse Width	Trigger on width of positive or negative pulses that are >, <, =, ≠, or inside/outside a specified period of time.								
Timeout	Trigger on an event which remains high, low, or either, for a specified time period (4 ns to 8 s).								
Runt	Trigger on a pulse that crosses one threshold but fails to cross a second threshold before crossing the first again.								
Logic	Trigger when any logical pattern of channels goes false or stays true for specified period of time. Any input can be used as a clock to look for the pattern on a clock edge. Pattern (AND, OR, NAND, NOR) specified for all input channels defined as High, Low, or Don't Care.								
Setup and Hold	Trigger on violations of both setup time and hold time between clock and data present on any of the analog and digital input channels.								
	<table border="1"> <thead> <tr> <th>Setup and hold trigger type</th> <th>Description</th> </tr> </thead> <tbody> <tr> <td>Setup Time Range</td> <td>-0.5 ns to 1.024 ms</td> </tr> <tr> <td>Hold Time Range</td> <td>1.0 ns to 1.024 ms</td> </tr> <tr> <td>Setup + Hold Time Range</td> <td>0.5 ns to 2.048 ms</td> </tr> </tbody> </table>	Setup and hold trigger type	Description	Setup Time Range	-0.5 ns to 1.024 ms	Hold Time Range	1.0 ns to 1.024 ms	Setup + Hold Time Range	0.5 ns to 2.048 ms
Setup and hold trigger type	Description								
Setup Time Range	-0.5 ns to 1.024 ms								
Hold Time Range	1.0 ns to 1.024 ms								
Setup + Hold Time Range	0.5 ns to 2.048 ms								
Rise/Fall Time	Trigger on pulse edge rates that are faster or slower than specified. Slope may be positive, negative, or either and time range is 4.0 ns to 8 s.								
Video	Trigger on all lines, odd, even, or all fields on NTSC, PAL, and SECAM video signals. 480p/60, 576p/50, 720p/30, 720p/50, 720p/60, 875i/60, 1080i/50, 1080i/60, 1080p/24, 1080p/24sF, 1080p/25, 1080p/30, 1080p/50, 1080p/60 Custom bi-level and tri-level sync video standards.								
I²C (optional)	Trigger on Start, Repeated Start, Stop, Missing ACK, Address (7 or 10 bit), Data, or Address and Data on I ² C buses up to 10 Mb/s.								
SPI (optional)	Trigger on SS active, Start of Frame, MOSI, MISO, or MOSI and MISO on SPI buses up to 50.0 Mb/s.								
RS-232/422/485/UART (optional)	Trigger on Tx Start Bit, Rx Start Bit, Tx End of Packet, Rx End of Packet, Tx Data, Rx Data, Tx Parity Error, and Rx Parity Error up to 10 Mb/s.								

Trigger system

USB: Low speed (optional)	<p>Trigger on Sync Active, Start of Frame, Reset, Suspend, Resume, End of Packet, Token (Address) Packet, Data Packet, Handshake Packet, Special Packet, Error.</p> <p>Token packet trigger - Any token type, SOF, OUT, IN, SETUP; Address can be specified for Any Token, OUT, IN, and SETUP token types. Address can be further specified to trigger on \leq, $<$, $=$, $>$, \geq, \neq a particular value, or inside or outside of a range. Frame number can be specified for SOF token using binary, hex, unsigned decimal and don't care digits.</p> <p>Data packet trigger - Any data type, DATA0, DATA1; Data can be further specified to trigger on \leq, $<$, $=$, $>$, \geq, \neq a particular data value, or inside or outside of a range.</p> <p>Handshake packet trigger - Any handshake type, ACK, NAK, STALL.</p> <p>Special packet trigger - Any special type, Reserved</p> <p>Error trigger - PID Check, CRC5 or CRC16, Bit Stuffing.</p>
USB: Full speed (optional)	<p>Trigger on Sync, Reset, Suspend, Resume, End of Packet, Token (Address) Packet, Data Packet, Handshake Packet, Special Packet, Error.</p> <p>Token packet trigger - Any token type, SOF, OUT, IN, SETUP; Address can be specified for Any Token, OUT, IN, and SETUP token types. Address can be further specified to trigger on \leq, $<$, $=$, $>$, \geq, \neq a particular value, or inside or outside of a range. Frame number can be specified for SOF token using binary, hex, unsigned decimal and don't care digits.</p> <p>Data packet trigger - Any data type, DATA0, DATA1; Data can be further specified to trigger on \leq, $<$, $=$, $>$, \geq, \neq a particular data value, or inside or outside of a range.</p> <p>Handshake packet trigger - Any handshake type, ACK, NAK, STALL.</p> <p>Special packet trigger - Any special type, PRE, Reserved.</p> <p>Error trigger - PID Check, CRC5 or CRC16, Bit Stuffing.</p>
CAN (optional)	<p>Trigger on Start of Frame, Frame Type (data, remote, error, overload), Identifier (standard or extended), Data, Identifier and Data, End of Frame, Missing ACK, or Bit Stuffing Error on CAN signals up to 1 Mb/s.</p> <p>Data can be further specified to trigger on \leq, $<$, $=$, $>$, \geq, or \neq a specific data value. User-adjustable sample point is set to 50% by default.</p>
LIN (optional)	<p>Trigger on Sync, Identifier, Data, Identifier and Data, Wakeup Frame, Sleep Frame, Errors such as Sync, Parity, or Checksum Errors up to 100 kb/s (by LIN definition, 20 kb/s).</p>
FlexRay (optional)	<p>Trigger on Start of Frame, Type of Frame (Normal, Payload, Null, Sync, Startup), Identifier, Cycle Count, Complete Header Field, Data, Identifier and Data, End of Frame or Errors such as Header CRC, Trailer CRC, Null Frame, Sync Frame, or Startup Frame Errors up to 100 Mb/s.</p>
MIL-STD-1553 (optional)	<p>Trigger on Sync, Word Type ¹ (Command, Status, Data), Command Word (set RT Address, T/R, Sub-address/Mode, Data Word Count/Mode Code, and Parity individually), Status Word (set RT Address, Message Error, Instrumentation, Service Request Bit, Broadcast Command Received, Busy, Subsystem Flag, Dynamic Bus Control Acceptance (DBCA), Terminal Flag, and Parity individually), Data Word (user-specified 16-bit data value), Error (Sync, Parity, Manchester, Non-contiguous data), Idle Time (minimum time selectable from 2 μs to 100 μs; maximum time selectable from 2 μs to 100 μs; trigger on $<$ minimum, $>$ maximum, inside range, outside range).</p> <p>RT Address can be further specified to trigger on $=$, \neq, $<$, $>$, \leq, \geq a particular value, or inside or outside of a range.</p>
I²S/LJ/RJ/TDM (optional)	<p>Trigger on Word Select, Frame Sync, or Data. Data can be further specified to trigger on \leq, $<$, $=$, $>$, \geq, \neq a specific data value, or inside or outside of a range. Maximum data rate for I²S/LJ/RJ is 12.5 Mb/s. Maximum data rate for TDM is 25 Mb/s.</p>
Parallel (available when option MDO3MSO is installed)	<p>Trigger on a parallel bus data value. Parallel bus can be from 1 to 20 bits (from the digital and analog channels) in size. Binary and Hex radices are supported.</p>

¹ Trigger selection of Command Word will trigger on Command and ambiguous Command/Status words. Trigger selection of Status Word will trigger on Status and ambiguous Command/Status words.

Acquisition system

Acquisition modes

Sample	Acquire sampled values.
Peak Detect	Captures glitches as narrow as 1.5 ns (1 GHz models), 2.0 ns (500 MHz models), 3.0 ns (350 MHz models), 5.0 ns (200 MHz models), 7.0 ns (100 MHz models) at all sweep speeds
Averaging	From 2 to 512 waveforms included in average.
Envelope	Min-max envelope reflecting Peak Detect data over multiple acquisitions. Number of waveforms in the envelope selectable between 1 and 2000 and infinity
Hi Res	Real-time boxcar averaging reduces random noise and increases vertical resolution.
Roll	Scrolls waveforms right to left across the screen at sweep speeds slower than or equal to 40 ms/div.
FastAcq™	FastAcq optimizes the instrument for analysis of dynamic signals and capture of infrequent events, capturing >280,000 wfms/s on 1 GHz models and >235,000 wfms/s on 100 MHz – 500 MHz models.

Waveform measurements

Cursors	Waveform and Screen
Automatic measurements (time domain)	30, of which up to four can be displayed on-screen at any one time. Measurements include: Period, Frequency, Delay, Rise Time, Fall Time, Positive Duty Cycle, Negative Duty Cycle, Positive Pulse Width, Negative Pulse Width, Burst Width, Phase, Positive Overshoot, Negative Overshoot, Total Overshoot, Peak to Peak, Amplitude, High, Low, Max, Min, Mean, Cycle Mean, RMS, Cycle RMS, Positive Pulse Count, Negative Pulse Count, Rising Edge Count, Falling Edge Count, Area and Cycle Area.
Automatic Measurements (frequency domain)	3, of which one can be displayed on-screen at any one time. Measurements include Channel Power, Adjacent Channel Power Ratio (ACPR), and Occupied Bandwidth (OBW)
Measurement statistics	Mean, Min, Max, Standard Deviation.
Reference levels	User-definable reference levels for automatic measurements can be specified in either percent or units.
Gating	Isolate the specific occurrence within an acquisition to take measurements on, using either the screen or waveform cursors.
Waveform histogram	A waveform histogram provides an array of data values representing the total number of hits inside of a user-defined region of the display. A waveform histogram is both a visual graph of the hit distribution as well as a numeric array of values that can be measured.
Sources	Channel 1, Channel 2, Channel 3, Channel 4, Ref 1, Ref 2, Ref 3, Ref 4, Math
Types	Vertical, Horizontal
Waveform histogram measurements	12, of which up to four can be displayed on-screen at any one time. Waveform Count, Hits in Box, Peak Hits, Median, Max, Min, Peak-to-Peak, Mean, Standard Deviation, Sigma 1, Sigma 2, Sigma 3

Waveform math

Arithmetic	Add, subtract, multiply, and divide waveforms.
Math functions	Integrate, differentiate, FFT
FFT	Spectral magnitude. Set FFT Vertical Scale to Linear RMS or dBV RMS, and FFT Window to Rectangular, Hamming, Hanning, or Blackman-Harris.

Waveform math

Spectrum math	Add or subtract frequency-domain traces.
Advanced Math	Define extensive algebraic expressions including waveforms, reference waveforms, math functions (FFT, Intg, Diff, Log, Exp, Sqrt, Abs, Sine, Cosine, Tangent, Rad, Deg), scalars, up to two user-adjustable variables and results of parametric measurements (Period, Freq, Delay, Rise, Fall, PosWidth, NegWidth, BurstWidth, Phase, PosDutyCycle, NegDutyCycle, PosOverShoot, NegOverShoot, TotalOverShoot, PeakPeak, Amplitude, RMS, CycleRMS, High, Low, Max, Min, Mean, CycleMean, Area, CycleArea, and trend plots). for example, $(\text{Intg}(\text{Ch1} - \text{Mean}(\text{Ch1})) \times 1.414 \times \text{VAR1})$

Act on Event

Events	None, when a trigger occurs, or when a defined number of acquisitions complete (1 to 1,000,000)
Actions	Stop acquisition, save waveform to file, save screen image, print, AUX OUT Pulse, remote interface SRQ, e-mail notification, and visual notification
Repeat	Repeat the act on event process (1 to 1,000,000 and infinity)

Video Picture mode

Sources	Channel 1, Channel 2, Channel 3, Channel 4
Video standards	NTSC, PAL
Contrast and brightness	Manual and automatic
Field selection	Odd, Even, Interlaced
Picture location on screen	Selectable X and Y location, width and height adjustment, start line and pixel and line-to-line offset control.

Power measurements (optional)

Power quality measurements	V_{RMS} , $V_{\text{Crest Factor}}$, Frequency, I_{RMS} , $I_{\text{Crest Factor}}$, True Power, Apparent Power, Reactive Power, Power Factor, Phase Angle.
Switching loss measurements	
Power loss	T_{on} , T_{off} , Conduction, Total.
Energy loss	T_{on} , T_{off} , Conduction, Total.
Harmonics	THD-F, THD-R, RMS measurements. Graphical and table displays of harmonics. Test to IEC61000-3-2 Class A and MIL-STD-1399, Section 300A.
Ripple measurements	V_{Ripple} and I_{Ripple} .
Modulation analysis	Graphical display of +Pulse Width, -Pulse Width, Period, Frequency, +Duty Cycle, and -Duty Cycle modulation types.
Safe operating area	Graphical display and mask testing of switching device safe operating area measurements.
dV/dt and dI/dt measurements	Cursor measurements of slew rate

Limit/Mask testing (optional)

Test source	Limit test: Any Ch1 - Ch4 or any R1 - R4 Mask test: Any Ch1 - Ch4
Mask creation	Limit test vertical tolerance from 0 to 1 division in 1 m division increments; Limit test horizontal tolerance from 0 to 500 m division in 1 m division increments. Load custom mask from text file with up to 8 segments.
Mask scaling	Lock to Source ON (mask automatically re-scales with source-channel settings changes) Lock to Source OFF (mask does not re-scale with source-channel settings changes)
Test criteria run until	Minimum number of waveforms (from 1 to 1,000,000 and Infinity) Minimum elapsed time (from 1 second to 48 hours and Infinity)
Violation threshold	From 1 to 1,000,000 and Infinity
Actions on test failure	Stop acquisition, save screen image to file, save waveform to file, print screen image, AUX OUT pulse, set remote interface SRQ
Actions on test complete	AUX OUT pulse, set remote interface SRQ
Results display	Test status, total waveforms, number of violations, total tests, failed tests, elapsed time, total hits for each mask segment

Arbitrary Function Generator

(Requires MDO3AFG option)

Waveforms	Sine, Square, Pulse, Ramp/Triangle, DC, Noise, Sin(x)/x (Sinc), Gaussian, Lorentz, Exponential Rise, Exponential Decay, Haversine, Cardiac, and Arbitrary.
------------------	--

Sine

Frequency range	0.1 Hz to 50 MHz
Amplitude range	20 mV _{p-p} to 5 V _{p-p} into Hi-Z; 10 mV _{p-p} to 2.5 V _{p-p} into 50 Ω
Amplitude flatness	±0.5 dB typical at 1 kHz (±1.5 dB for <20 mV _{p-p} amplitudes)
Total harmonic distortion (typical)	1% into 50Ω 2% for amplitude < 50 mV and frequencies > 10 MHz 3% for amplitude < 20 mV and frequencies > 10 MHz
Spurious free dynamic range (SFDR)	-40 dBc (V _{p-p} ≥ 0.1 V); -30dBc (V _{p-p} ≤ 0.1 V), 50 Ω load

Square / Pulse

Frequency range	0.1 Hz to 25 MHz
Amplitude range	20 mV _{p-p} to 5 V _{p-p} into Hi-Z; 10 mV _{p-p} to 2.5 V _{p-p} into 50 Ω
Duty cycle	10% to 90% or 10 ns minimum pulse, whichever is larger cycle
Duty cycle resolution	0.1%
Pulse width minimum	10 ns typical
Rise/fall time	5 ns typical (10% - 90%)
Pulse width resolution	100 ps
Overshoot	< 2% typical for signal steps greater than 100 mV
Asymmetry	±1% ±5 ns, at 50% duty cycle
Jitter (TIE RMS)	< 500 ps typical

Arbitrary Function Generator

Ramp / Triangle

Frequency range	0.1 Hz to 500 kHz
Amplitude range	20 mV _{p-p} to 5 V _{p-p} into Hi-Z; 10 mV _{p-p} to 2.5 V _{p-p} into 50 Ω
Variable symmetry	0% to 100%
Symmetry resolution	0.1%

DC

Level range	±2.5 V into Hi-Z; ±1.25 V into 50 Ω
-------------	-------------------------------------

Noise

Amplitude range	20 mV _{p-p} to 5 V _{p-p} in to Hi-Z; 10 mV _{p-p} to 2.5 V _{p-p} into 50 Ω
Amplitude resolution	0% to 100% in 1% increments

Sin(x)/x (Sinc)

Frequency range	0.1 Hz to 2 MHz
Amplitude range	20 mV _{p-p} to 3.0 V _{p-p} into Hi-Z; 10 mV _{p-p} to 1.5 V _{p-p} into 50 Ω

Gaussian

Frequency range	0.1 Hz to 5 MHz
Amplitude range	20 mV _{p-p} to 2.5 V _{p-p} into Hi-Z; 10 mV _{p-p} to 1.25 V _{p-p} into 50 Ω

Lorentz

Frequency range	0.1 Hz to 5 MHz
Amplitude range	20 mV _{p-p} to 2.4 V _{p-p} into Hi-Z; 10 mV _{p-p} to 1.2 V _{p-p} into 50 Ω

Exponential Rise / Decay

Frequency range	0.1 Hz to 5 MHz
Amplitude range	20 mV _{p-p} to 2.5 V _{p-p} into Hi-Z; 10 mV _{p-p} to 1.25 V _{p-p} into 50 Ω

Haversine

Frequency range	0.1 Hz to 5 MHz
Amplitude range	20 mV _{p-p} to 2.5 V _{p-p} into Hi-Z; 10 mV _{p-p} to 1.25 V _{p-p} into 50 Ω

Cardiac

Frequency range	0.1 Hz to 500 kHz
Amplitude range	20 mV _{p-p} to 5 V _{p-p} into Hi-Z; 10 mV _{p-p} to 2.5 V _{p-p} into 50 Ω

Arbitrary

Memory depth	1 to 128 k
Amplitude range	20 mV _{p-p} to 5 V _{p-p} into Hi-Z; 10 mV _{p-p} to 2.5 V _{p-p} into 50 Ω
Repetition rate	0.1 Hz to 25 MHz
Sample rate	250 MS/s

Frequency accuracy

Sine wave and ramp	130 ppm (frequency < 10 kHz)
	50 ppm (frequency ≥ 10 kHz)
Square wave and pulse	130 ppm (frequency < 10 kHz)
	50 ppm (frequency ≥ 10 kHz)
Resolution	0.1 Hz or 4 digits; whichever is larger

Arbitrary Function Generator

Amplitude accuracy	$\pm[(1.5\% \text{ of peak-to-peak amplitude setting}) + (1.5\% \text{ of DC offset setting}) + 1 \text{ mV}]$ (frequency = 1 kHz)
DC offset	
DC offset range	$\pm[2.5 \text{ V} - (\text{signal amplitude}) / 2]$ into Hi-Z; $\pm[1.25 - (\text{signal amplitude}) / 2]$ into 50 Ω
DC offset resolution	1 mV into Hi-Z; 500 μV into 50 Ω
Offset accuracy	$\pm[(1.5\% \text{ of absolute offset voltage setting}) + 1 \text{ mV}]$; derated 3 mV for every 10 $^{\circ}\text{C}$ away from 25 $^{\circ}\text{C}$
ArbExpress[®]	The MDO3000 is compatible with ArbExpress [®] PC-based signal generator waveform creation and editing software. Capture waveforms on the MDO3000 oscilloscope and transfer them to ArbExpress for editing. Create complex waveforms in ArbExpress and transfer them to the arbitrary function generator in the MDO3000 for output. To download ArbExpress software, go to www.tektronix.com/downloads .

Digital voltmeter (DVM) and frequency counter

Source	Channel 1, Channel 2, Channel 3, Channel 4
Measurement types	AC RMS, DC, AC+DC RMS (reads out in volts or amps); Frequency
Resolution	ACV, DCV: 4 digits Frequency: 5 digits
Frequency accuracy	10 ppm
Measuring rate	100 times/second; measurements updated on the display 4 times/second
Vertical settings autorange	Automatic adjustment of vertical settings to maximize measurement dynamic range; available for any non-trigger source
Graphical measurement	Graphical indication of minimum, maximum, current value, and five second rolling range

Software

OpenChoice[®] Desktop	Enables fast and easy communication between a Windows PC and your oscilloscope using USB or LAN. Transfer and save settings, waveforms, measurements, and screen images. Word and Excel toolbars automate the transfer of acquisition data and screen images from the oscilloscope into Word and Excel for quick reporting or further analysis.
IVI driver	Provides a standard instrument programming interface for common applications such as LabVIEW, LabWindows/CVI, MicrosoftNET, and MATLAB.
e*Scope[®] Web-based interface	Enables control of the oscilloscope over a network connection through a standard web browser. Simply enter the IP address or network name of the oscilloscope and a web page will be served to the browser. Transfer and save settings, waveforms, measurements, and screen images or make live control changes to settings on the oscilloscope directly from the web browser.
LXI Core 2011 Web interface	Connect to the oscilloscope through a standard Web browser by simply entering the oscilloscope IP address or network name in the address bar of the browser. The Web interface enables viewing of instrument status and configuration, status and modification of network settings, and instrument control through e*Scope Web-based remote control. All Web interaction conforms to LXI Core 2011 specification, version 1.4.

Display system

Display type	9 in. (229 mm) color display
Display resolution	800 horizontal × 480 vertical pixels (WVGA)
Interpolation	Sin(x)/x
Waveform styles	Vectors, Dots, Variable Persistence, Infinite Persistence
FastAcq. palettes	Temperature, Spectral, Normal, Inverted
Graticules	Full, Grid, Solid, Cross Hair, Frame, IRE and mV
Format	YT, XY, and simultaneous XY/YT
Maximum waveform capture rate	>280,000 wfms/s in FastAcq acquisition mode for 1 GHz models >235,000 wfms/s in FastAcq acquisition mode for 100 MHz – 500 MHz models >50,000 wfms/s in DPO acquisition mode on all models

Input/output ports

USB 2.0 high-speed host port	Supports USB mass storage devices, printers and keyboard. One port on front and one port on rear of instrument.
USB 2.0 device port	Rear-panel connector allows for communication/control of oscilloscope through USBTMC or GPIB (with a TEK-USB-488), and direct printing to PictBridge-compatible printers.
Printing	Print to network printer, PictBridge printer, or to a printer that supports e-mail printing. Note: This product includes software developed by the OpenSSL Project for use in the OpenSSL Toolkit. (http://www.openssl.org/)
LAN port	RJ-45 connector, supports 10/100 Mb/s
Video out port	DB-15 female connector, connect to show the oscilloscope display on an external monitor or projector. XGA resolution.
Auxilliary input	(Available on two-channel models only)
Front-panel BNC connector	Input impedance, 1 MΩ
Maximum input	300 V _{RMS} CAT II with peaks ≤ ±425 V
Probe compenstor output voltage and frequency	Front-panel pins
Amplitude	0 to 2.5 V
Frequency	1 kHz
Auxiliary out	Rear-panel BNC connector V _{OUT} (Hi): ≥2.25 V open circuit, ≥0.9 V 50 Ω to ground V _{OUT} (Lo): ≤0.7 V into a load of ≤4 mA; ≤0.25 V 50 Ω to ground Output can be configured to provide a pulse out signal when the oscilloscope triggers, a trigger signal from the internal arbitrary function generator, or an event out for limit/mask testing.
Kensington-style lock	Rear-panel security slot connects to standard Kensington-style lock.
VESA mount	Standard (MIS-D 75) 75 mm VESA mounting points on rear of instrument.

LAN eXtensions for Instrumentation (LXI)

Class	LXI Core 2011
--------------	---------------

Version	V1.4
----------------	------

Power source

Power source voltage	100 to 240 V \pm 10%
-----------------------------	------------------------

Power source frequency	50 to 60 Hz at 100 to 240 V 400 Hz \pm 10% at 115 V
-------------------------------	--

Power consumption	120 W maximum
--------------------------	---------------

Physical characteristics**Dimensions**

Height	203.2 mm (8 in.)
Width	416.6 mm (16.4 in.)
Depth	147.4 mm (5.8 in.)

Weight

Net	4.2 kg (9.2 lb.)
Shipping	8.6 kg (19 lb.)

Rackmount configuration	5U
--------------------------------	----

Cooling clearance	2 in. (51 mm) required on left side and rear of instrument
--------------------------	--

EMC, environment, and safety**Temperature**

Operating	-10 °C to +55 °C (+14 °F to 131 °F)
Nonoperating	-40 °C to +71 °C (-40 °F to 160 °F)

Humidity

Operating	Up to +40 °C, 5% to 90% relative humidity +40 °C to +55 °C, 5% to 60% relative humidity
Nonoperating	Up to +40 °C, 5% to 90% relative humidity Above +40 °C up to +55 °C, 5% to 60% relative humidity Above +55 °C up to +71 °C, 5% to 40% relative humidity, non-condensing

Altitude

Operating	3,000 meters (9,843 feet)
Nonoperating	12,000 meters (39,370 feet)

Regulatory

Electromagnetic compatibility	EC Council Directive 2004/108/EC
Safety	UL61010-1:2004, CAN/CSA-C22.2 No. 61010.1: 2004, Low Voltage Directive 2006/95/EC and EN61010-1:2001, IEC 61010-1:2001, ANSI 61010-1-2004, ISA 82.02.01

Ordering information

Step 1: Choose the MDO3000 base model

MDO3000 family

MDO3012	Mixed Domain Oscilloscope with (2) 100 MHz analog channels, and (1) 100 MHz spectrum analyzer input
MDO3014	Mixed Domain Oscilloscope with (4) 100 MHz analog channels, and (1) 100 MHz spectrum analyzer input
MDO3022	Mixed Domain Oscilloscope with (2) 200 MHz analog channels, and (1) 200 MHz spectrum analyzer input
MDO3024	Mixed Domain Oscilloscope with (4) 200 MHz analog channels, and (1) 200 MHz spectrum analyzer input
MDO3032	Mixed Domain Oscilloscope with (2) 350 MHz analog channels, and (1) 350 MHz spectrum analyzer input
MDO3034	Mixed Domain Oscilloscope with (4) 350 MHz analog channels, and (1) 350 MHz spectrum analyzer input
MDO3052	Mixed Domain Oscilloscope with (2) 500 MHz analog channels, and (1) 500 MHz spectrum analyzer input
MDO3054	Mixed Domain Oscilloscope with (4) 500 MHz analog channels, and (1) 500 MHz spectrum analyzer input
MDO3102	Mixed Domain Oscilloscope with (2) 1 GHz analog channels, and (1) 1 GHz spectrum analyzer input
MDO3104	Mixed Domain Oscilloscope with (4) 1 GHz analog channels, and (1) 1 GHz spectrum analyzer input

Standard accessories

Probes

100 MHz, 200 MHz models	TPP0250, 250 MHz bandwidth, 10X, 3.9 pF. One passive voltage probe per analog channel
350 MHz, 500 MHz models	TPP0500B, 500 MHz bandwidth, 10X, 3.9 pF. One passive voltage probe per analog channel
1 GHz models	TPP1000, 1 GHz bandwidth, 10X, 3.9 pF. One passive voltage probe per analog channel
Any model with MDO3MSO option	One P6316 16-channel logic probe and accessories

Accessories

103-0473-00	N-to-BNC adapter
063-4526-xx	Documentation CD
071-3249-00	Installation and Safety Instructions, printed manual (translated in English, Japanese, and Simplified Chinese)
016-2008-xx	Accessory bag
-	Power cord
-	OpenChoice® Desktop Software (available on the Documentation CD and for download from www.tektronix.com/downloads .)
-	Calibration certificate documenting traceability to National Metrology Institute(s) and ISO9001 quality system registration

Warranty

Three-year warranty covering all parts and labor, excluding probes.

Step 2: Configure your MDO3000 by adding instrument options**Instrument options**

All MDO3000 Series instruments can be preconfigured from the factory with the following options:

MDO3AFG	Arbitrary function generator with 13 predefined waveforms and arbitrary waveform generation
MDO3MSO	16 digital channels; includes P6316 digital probe and accessories
MDO3SA	Increase spectrum analyzer input frequency range to 9 kHz – 3 GHz and capture bandwidth to 3 GHz.
MDO3SEC	Enhanced instrument security to enable password protected control of turning on/off all instrument ports and instrument firmware update functionality.

Power cord and plug options

Opt. A0	North America power plug (115 V, 60 Hz)
Opt. A1	Universal Euro power plug (220 V, 50 Hz)
Opt. A2	United Kingdom power plug (240 V, 50 Hz)
Opt. A3	Australia power plug (240 V, 50 Hz)
Opt. A5	Switzerland power plug (220 V, 50 Hz)
Opt. A6	Japan power plug (100 V, 110/120 V, 60 Hz)
Opt. A10	China power plug (50 Hz)
Opt. A11	India power plug (50 Hz)
Opt. A12	Brazil power plug (60 Hz)
Opt. A99	No power cord

Language options

All products are shipped with an Installation and Safety manual that is in English, Japanese, and Simplified Chinese. Full user manuals translated in each language listed below are included with each product in pdf format on the Documentation CD.

Opt. L0	English front panel label
Opt. L1	French front panel overlay
Opt. L2	Italian front panel overlay
Opt. L3	German front panel overlay
Opt. L4	Spanish front panel overlay
Opt. L5	Japanese front panel overlay
Opt. L6	Portuguese front panel overlay
Opt. L7	Simplified Chinese front panel overlay
Opt. L8	Traditional Chinese front panel overlay
Opt. L9	Korean front panel overlay

Opt. L10	Russian front panel overlay
Opt. L99	No manual, English front panel label

Service options

Opt. C3	Calibration Service 3 Years
Opt. C5	Calibration Service 5 Years
Opt. D1	Calibration Data Report
Opt. D3	Calibration Data Report 3 Years (with Opt. C3)
Opt. D5	Calibration Data Report 5 Years (with Opt. C5)
Opt. G3	Complete Care 3 Years (includes loaner, scheduled calibration, and more)
Opt. G5	Complete Care 5 Years (includes loaner, scheduled calibration, and more)
Opt. R5	Repair Service 5 Years (including warranty)

Probes and accessories are not covered by the oscilloscope warranty and service offerings. Refer to the datasheet of each probe and accessory model for its unique warranty and calibration terms.

Step 3: Select application models and accessories

Application modules	<p>Application modules are purchased as stand-alone products and can be purchased at the time of initial MDO3000 purchase or at any future time.</p> <p>Application modules have licenses which can be transferred between an application module and an oscilloscope. The license may be contained in the module; allowing the module to be moved from one instrument to another. Or, the license can be contained in the oscilloscope; allowing the module to be removed and stored for safekeeping. The license can be transferred back to the module for use in another MDO3000 oscilloscope. Transferring the license to an oscilloscope and removing the module permits the use of more than two applications simultaneously.</p>
MDO3AERO	<p>Aerospace Serial Triggering and Analysis Module. Enables triggering on packet-level information on MIL-STD-1553 buses as well as analytical tools such as digital views of the signal, bus views, packet decoding, search tools, and packet decode tables with time- stamp information.</p> <p>Signal Inputs - Any Ch1 - Ch4, Math, Ref1 - Ref4</p> <p>Recommended Probing - Differential or single ended (only one single-ended signal required)</p>
MDO3AUDIO	<p>Audio Serial Triggering and Analysis Module. Enables triggering on packet-level information on I²S, LJ, RJ, and TDM audio buses as well as analytical tools such as digital views of the signal, bus views, packet decoding, search tools, and packet decode tables with time-stamp information.</p> <p>Signal Inputs - Any Ch1 - Ch4, any D0 - D15</p> <p>Recommended Probing - Single ended</p>
MDO3AUTO	<p>Automotive Serial Triggering and Analysis Module. Enables triggering on packet-level information on CAN and LIN buses as well as analytical tools such as digital views of the signal, bus views, packet decoding, search tools, and packet decode tables with time- stamp information.</p> <p>Signal Inputs – CAN or LIN: Any Ch1 - Ch4, any D0 - D15</p> <p>Recommended Probing - CAN: Single ended or differential; LIN: Single ended</p>
MDO3COMP	<p>Computer Serial Triggering and Analysis Module. Enables triggering on packet-level information on RS-232/422/485/UART buses as well as analytical tools such as digital views of the signal, bus views, packet decoding, search tools, and packet decode tables with time-stamp information.</p> <p>Signal Inputs - Any Ch1 - Ch4, any D0 - D15</p> <p>Recommended Probing - RS-232/UART: Single ended; RS-422/485: Differential</p>

MDO3EMBD	<p>Embedded Serial Triggering and Analysis Module. Enables triggering on packet-level information on I2C and SPI buses as well as analytical tools such as digital views of the signal, bus views, packet decoding, search tools, and packet decode tables with time-stamp information.</p> <p>Signal Inputs - I²C or SPI: Any Ch1 - Ch4, any D0 - D15</p> <p>Recommended Probing - Single ended</p>
MDO3FLEX	<p>FlexRay Serial Triggering and Analysis Module. Enables triggering on packet-level information on FlexRay buses as well as analytical tools such as digital views of the signal, bus views, packet decoding, search tools, packet decode tables with time-stamp information.</p> <p>Signal Inputs - Any Ch1 - Ch4 (and any D0 - D15 when MDO3MSO option is installed; single-ended probing only)</p> <p>Recommended Probing - Single ended or differential</p>
MDO3USB	<p>USB Serial Triggering and Analysis Module. Enables triggering on packet-level content for low-speed, and full-speed USB serial buses. Also enables analytical tools such as digital views of the signal, bus views, packet decoding, search tools, and packet decode tables with time-stamp information for low-speed, full-speed, and high-speed USB serial buses.</p> <p>Signal Inputs - Low-speed and Full-speed: Any Ch1 - Ch4, any D0 - D15; Low-speed, Full-speed, and High-speed: Any Ch1 - Ch4, Math, Ref1 - Ref4</p> <p>Note: High-speed decode support only available on 1 GHz models.</p> <p>Recommended Probing - Low-speed and Full-speed: Single ended or differential; High-speed: Differential</p>
MDO3PWR	<p>Power Analysis Application Module. Enables quick and accurate analysis of power quality, switching loss, harmonics, safe operating area (SOA), modulation, ripple, and slew rate (dl/dt, dV/dt).</p>
MDO3LMT	<p>Limit and Mask Testing Application Module. Enables testing against limit templates generated from "golden" waveforms and mask testing using custom masks.</p>

Recommended accessories

Probes

Tektronix offers over 100 different probes to meet your application needs. For a comprehensive listing of available probes, please visit www.tektronix.com/probes.

TPP0250	250 MHz, 10X TekVPI® passive voltage probe with 3.9 pF input capacitance
TPP0500B	500 MHz, 10X TekVPI® passive voltage probe with 3.9 pF input capacitance
TPP0502	500 MHz, 2X TekVPI® passive voltage probe with 12.7 pF input capacitance
TPP0850	2.5 kV, 800 MHz, 50X TekVPI® passive high-voltage probe
TPP1000	1 GHz, 10X TekVPI® passive voltage probe with 3.9 pF input capacitance
TAP1500	1.5 GHz TekVPI® active single-ended voltage probe
TAP2500	2.5 GHz TekVPI® active single-ended voltage probe
TAP3500	3.5 GHz TekVPI® active single-ended voltage probe
TCP0020	50 MHz TekVPI® 20 Ampere AC/DC current probe
TCP0030A	120 MHz TekVPI® 30 Ampere AC/DC current probe
TCP0150	20 MHz TekVPI® 150 Ampere AC/DC current probe
TDP0500	500 MHz TekVPI® differential voltage probe with ±42 V differential input voltage
TDP1000	1 GHz TekVPI® differential voltage probe with ±42 V differential input voltage
TDP1500	1.5 GHz TekVPI® differential voltage probe with ±8.5 V differential input voltage
TDP3500	3.5 GHz TekVPI® differential voltage probe with ±2 V differential input voltage
THDP0200	±1.5 kV, 200 MHz TekVPI® high-voltage differential probe

Datasheet

THDP0100	±6 kV, 100 MHz TekVPI® high-voltage differential probe
TMDP0200	±750 V, 200 MHz TekVPI® high-voltage differential probe

Accessories

TPA-N-PRE	Preamplifier, 12 dB nominal Gain, 9 kHz - 6 GHz
TPA-N-VPI	N-to-TekVPI adapter
119-4146-00	Near field probe set, 100 kHz - 1 GHz
119-6609-00	Flexible monopole antenna
077-0981-xx	Service manual (English only)
TPA-BNC	TekVPI® to TekProbe™ BNC adapter
TEK-DPG	TekVPI Deskew pulse generator signal source
067-1686-xx	Power measurement deskew and calibration fixture
SignalVu-PC-SVE	Vector Signal Analysis Software
TEK-USB-488	GPIO-to-USB adapter
ACD3000	Soft transit case (includes front protective cover)
HCTEK54	Hard transit case (requires ACD3000)
RMD3000	Rackmount kit
200-5052-00	Front protective cover

Other RF probes

Contact Beehive Electronics to order: <http://beehive-electronics.com/probes.html>

101A	EMC probe set
150A	EMC probe amplifier
110A	Probe cable
0309-0001	SMA probe adapter
0309-0006	BNC probe adapter

Step 4: Add instrument upgrades in the future

Instrument upgrades

The MDO3000 Series products offer a number of ways to add functionality after the initial purchase. Listed below are the various product upgrades available and the method of upgrade used for each product.

Post-purchase instrument options	The following products are sold as stand-alone products and can be purchased at any time to add functionality to any MDO3000 product.
MDO3AFG	Add arbitrary function generator to any MDO3000 Series product. One-time, permanent upgrade to any model enabled through single-use application module hardware key. The hardware key is used to enable the feature and then is not required for future use.
MDO3MSO	Add 16 digital channels; includes P6316 digital probe and accessories . One-time, permanent upgrade to any model enabled through single-use application module hardware key. The hardware key is used to enable the feature and then is not required for future use.
MDO3SA	Increase spectrum analyzer input frequency range to 9 kHz – 3 GHz and capture bandwidth to 3 GHz. One-time, permanent upgrade to any model enabled through single-use application module hardware key. The hardware key is used to enable the feature and then is not required for future use.
MDO3SEC	Add enhanced instrument security to enable password protected control of turning on/off all instrument ports and instrument firmware update functionality. One-time, permanent upgrade to any model enabled through software option key. Software option key products require that the instrument model and serial number be provided at the time of purchase. The software option key is specific to the model and serial number combination.

Bandwidth upgrade options

Instrument bandwidth can be upgraded on any MDO3000 Series product after initial purchase. Each upgrade product will increase the analog bandwidth and the spectrum analyzer frequency range to the new bandwidth level. Bandwidth upgrades are purchased based on the combination of the current bandwidth and the desired bandwidth. Software option key products require that the instrument model and serial number be provided at the time of purchase. The software option key is specific to the model and serial number combination. Bandwidth upgrades up to 500 MHz can be performed in the field. Bandwidth upgrades to 1 GHz require installation at a Tektronix service center. The table below shows the various bandwidth upgrade products to purchase based on current and desired bandwidth levels.

Model to be upgraded	Bandwidth before upgrade	Bandwidth after upgrade	Order product
MDO3012	100 MHz	200 MHz	MDO3BW1T22
	100 MHz	350 MHz	MDO3BW1T32
	100 MHz	500 MHz	MDO3BW1T52
	100 MHz	1 GHz	MDO3BW1T102
	200 MHz	350 MHz	MDO3BW2T32
	200 MHz	500 MHz	MDO3BW2T52
	200 MHz	1 GHz	MDO3BW2T102
	350 MHz	500 MHz	MDO3BW3T52
	350 MHz	1 GHz	MDO3BW3T102
	500 MHz	1 GHz	MDO3BW5T102
MDO3014	100 MHz	200 MHz	MDO3BW1T24
	100 MHz	350 MHz	MDO3BW1T34
	100 MHz	500 MHz	MDO3BW1T54
	100 MHz	1 GHz	MDO3BW1T104
	200 MHz	350 MHz	MDO3BW2T34
	200 MHz	500 MHz	MDO3BW2T54
	200 MHz	1 GHz	MDO3BW2T104
	350 MHz	500 MHz	MDO3BW3T54
	350 MHz	1 GHz	MDO3BW3T104
	500 MHz	1 GHz	MDO3BW5T104
MDO3022	200 MHz	350 MHz	MDO3BW2T32
	200 MHz	500 MHz	MDO3BW2T52
	200 MHz	1 GHz	MDO3BW2T102
	350 MHz	500 MHz	MDO3BW3T52
	350 MHz	1 GHz	MDO3BW3T102
	500 MHz	1 GHz	MDO3BW5T102
MDO3024	200 MHz	350 MHz	MDO3BW2T34
	200 MHz	500 MHz	MDO3BW2T54
	200 MHz	1 GHz	MDO3BW2T104
	350 MHz	500 MHz	MDO3BW3T54
	350 MHz	1 GHz	MDO3BW3T104
	500 MHz	1 GHz	MDO3BW5T104
MDO3032	350 MHz	500 MHz	MDO3BW3T52
	350 MHz	1 GHz	MDO3BW3T102
	500 MHz	1 GHz	MDO3BW5T102
MDO3034	350 MHz	500 MHz	MDO3BW3T54
	350 MHz	1 GHz	MDO3BW3T104
	500 MHz	1 GHz	MDO3BW5T104

Model to be upgraded	Bandwidth before upgrade	Bandwidth after upgrade	Order protduct
MDO3052	500 MHz	1 GHz	MDO3BW5T102
MDO3054	500 MHz	1 GHz	MDO3BW5T104



Tektronix is registered to ISO 9001 and ISO 14001 by SRI Quality System Registrar.



Product(s) complies with IEEE Standard 488.1-1987, RS-232-C, and with Tektronix Standard Codes and Formats.

ASEAN / Australasia (65) 6356 3900
Belgium 00800 2255 4835*
Central East Europe and the Baltics +41 52 675 3777
Finland +41 52 675 3777
Hong Kong 400 820 5835
Japan 81 (3) 6714 3010
Middle East, Asia, and North Africa +41 52 675 3777
People's Republic of China 400 820 5835
Republic of Korea 001 800 8255 2835
Spain 00800 2255 4835*
Taiwan 886 (2) 2722 9622

Austria 00800 2255 4835*
Brazil +55 (11) 3759 7627
Central Europe & Greece +41 52 675 3777
France 00800 2255 4835*
India 000 800 650 1835
Luxembourg +41 52 675 3777
The Netherlands 00800 2255 4835*
Poland +41 52 675 3777
Russia & CIS +7 (495) 6647564
Sweden 00800 2255 4835*
United Kingdom & Ireland 00800 2255 4835*

Balkans, Israel, South Africa and other ISE Countries +41 52 675 3777
Canada 1 800 833 9200
Denmark +45 80 88 1401
Germany 00800 2255 4835*
Italy 00800 2255 4835*
Mexico, Central/South America & Caribbean 52 (55) 56 04 50 90
Norway 800 16098
Portugal 80 08 12370
South Africa +41 52 675 3777
Switzerland 00800 2255 4835*
USA 1 800 833 9200

* European toll-free number. If not accessible, call: +41 52 675 3777

Updated 10 April 2013

For Further Information. Tektronix maintains a comprehensive, constantly expanding collection of application notes, technical briefs and other resources to help engineers working on the cutting edge of technology. Please visit www.tektronix.com.

Copyright © Tektronix, Inc. All rights reserved. Tektronix products are covered by U.S. and foreign patents, issued and pending. Information in this publication supersedes that in all previously published material. Specification and price change privileges reserved. TEKTRONIX and TEK are registered trademarks of Tektronix, Inc. All other trade names referenced are the service marks, trademarks, or registered trademarks of their respective companies.



04 Feb 2014

48W-30020-1

www.tektronix.com





Product information

Weller®

WX 2021 Set

Code No. : **T0053422699**

Power unit with 2 channels

Power unit WX 2, 200 W, soldering iron WXMP, 55 W, 12 V, with Active Tip Technology, soldering tip RT 3, safety rest WDH 51, micro tweezers WXMT, 2 x 40 W, 12 V, with Active Tip Technology, standard tip RTW 2 and safety rest WDH 60 with dry cleaner

Technical Data



This station is ESD safe.

Dimensions L x W x H:	170 x 151 x 130 mm (6,69 x 5,94 x 5,12 inch)
Weight:	approx. 3,2 kg
Channels:	2
Power supply:	230 V, 50 Hz
Power consumption:	200 W (255 W)
Protection class:	I
Temperature range:	Adjustable from 50°C - 550°C (150°F - 999°C) Adjustable temperature range varies among tools
Temperature accuracy:	± 9°C (± 17°F)
Temperature stability:	± 2°C (± 4°F)
Equipotential bonding:	Via 3,5 mm pawl socket on back of device
Material touch panel:	Made of antistatic coated material
Dimensions touch panel:	74 x 38 mm
Resolution:	255 x 127 (128) dots

Display backlighting:	4 LEDs
Equipotential bonding:	The 3,5 mm switch offers four different options: a) Hard grounded without plug (original delivery) b) Equipotential bonding: with plug, compensation line on center contact c) Potential free: with plug d) Soft grounded: with plug and soldered resistor grounded via selected resistor
USB interface:	USB interface in front of firmware updates, parameterization and monitoring USB interface supports all standard USBflash drive types

Power unit WX 2

- Innovative operation concept
- Robust touch screen with ESD safe glass
- Intuitive use with turn-click-wheel with enter key and finger guide.
- Blue LED backlighting
- Multilingual menu navigation
- High functionality
- No safety rest with Stop & Go function needed thanks to integrated acceleration sensor
- Optimized precision, better stability by sensor in the soldering iron
- Specific parameterization of tool by storage medium in hand piece.
- Visual process control via blue LED ring light
- All WX tools connectable

3-Year
Warranty

2220, 2220G, 2230, 2230G

Multi-Channel USB and USB/GPIB Programmable DC Power Supplies



- Dual and triple output models with two 30V/1.5A (45W) channels and a 6V/5A (30W) channel on the triple output supply
- All channels are independently controlled and have isolated outputs for maximum flexibility
- All channels have remote sensing to ensure that programmed voltage is accurately applied to the load
- Two 30V channels can be combined either in series to double output voltage or in parallel to double output current
- 0.03% basic voltage output accuracy and 0.1% current accuracy ensure quality test data
- Low noise, linear regulation with <math><3\text{mVpp}</math> ripple and noise
- Voltage and current outputs for all channels are displayed simultaneously for easy observation of each output state
- Keypad entry allows fast, precise entry of output values
- USB interface standard on all versions for remote control; "G" versions include USB and GPIB interfaces

The Models 2220, 2220G, 2230, and 2230G Multi-Channel Programmable DC Power Supplies combine two and three channels of output power to cost-effectively characterize and test a wide range of devices, circuit boards, modules, and products that require more than one power source. The Models 2220-30-1 and 2220G-30-1 supplies provide two channels, with each channel capable of outputting up to 30V and up to 1.5A. The Models 2230-30-1 and 2230G-30-1 include two 30V/1.5A channels and add a 6V channel with up to 5A output for powering digital circuits. These multi-channel power supplies offer an excellent combination of performance, versatility, and ease of use to maximize the information from characterization or test as quickly and as easily as possible. They perform as effectively in automated test systems as they do in manual instrument configurations. The USB interface is standard on all models; the "G" versions add a GPIB interface.

Independent and Isolated Outputs

Since each channel in these multi-channel power supplies is completely independent and isolated from each other, these power supplies can be used to provide power to two circuits that are optically isolated or transformer-isolated from each other and have different reference points. Their isolated channels eliminate the need for a second power supply to power one of the isolated circuits.

Additionally, each channel can be independently controlled, so channels can be individually turned on and turned off at any time. Thus, these power supplies can be used to power up a circuit with multiple voltage levels (such as a digital circuit) that must be turned on in a specified time sequence. Furthermore, the timer capability allows you to set up unattended tests that turn off the channels after a programmed time interval to protect a device-under-test (DUT) from potential damage due to the continuous application of power beyond a recommended time interval. Both isolated and independent channels provide excellent versatility and flexibility to address a wide range of test applications.

Accurate Power Delivery to the Load

With basic voltage setting accuracy and voltage readback accuracy of 0.03% for each channel, the exact voltage programmed for any channel is applied at the output terminals. Plus, the rear panel connections for each channel include remote sense terminals that compensate for voltage drops in the power supply leads. This helps to ensure that the correct voltage is delivered accurately to the load terminals of the DUT. Many other multi-channel power supplies do not provide remote sensing, which reduces overall system accuracy.

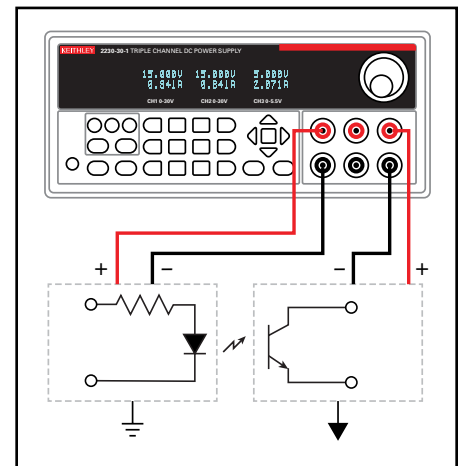

Power two isolated circuits with isolated output channels.

Multi-channel programmable DC power supplies

DC POWER SUPPLIES

1.888.KEITHLEY (U.S. only)

www.keithley.com

KEITHLEY

A Greater Measure of Confidence

A Tektronix Company

2220, 2220G, 2230, 2230G

Ordering Information

2220-30-1

Programmable Dual Channel
DC Power Supply

2220G-30-1

Programmable Dual Channel DC
Power Supply with GPIB Interface

2220J-30-1

Programmable Dual Channel
DC Power Supply for Japan

2220GJ-30-1

Programmable Dual Channel
DC Power Supply with GPIB
Interface for Japan

2230-30-1

Programmable Triple
Channel DC Power Supply

2230G-30-1

Programmable Triple Channel DC
Power Supply with GPIB Interface

2230J-30-1

Programmable Triple Channel
DC Power Supply for Japan

2230GJ-30-1

Programmable Triple Channel
DC Power Supply with GPIB
Interface for Japan

Accessories Supplied

CS-1655-15 Rear Panel Mating
Connector for Models 2220 and 2230
Multi-Channel DC Power Supplies
Documentation and Driver CD

ACCESSORIES AVAILABLE

CS-1655-15	Rear Panel Mating Connector for Series 2200 Power Supplies
Model Number JUMPER (example: 2230-30-1 JUMPER)	Shorting Jumper for CS-1655-15 Connector
4299-7	Universal Fixed Rack Mount Kit
RMU2U	Fixed Rack Mount Kit
386-7598-xx	RMU2U Rack Mount Cosmetic Filler Panel
USB-1-1	USB Cable
KPCI-488LPA	IEEE-488.2 Interface Board for the PCI Bus
7007-05	Double Shielded Premium IEEE-488 Interface Cables, 0.5m (1.6 ft)
7007-1	Double Shielded Premium IEEE-488 Interface Cables, 1m (3.2 ft)
7007-2	Double Shielded Premium IEEE-488 Interface Cables, 2m (6.5 ft)
7007-3	Double Shielded Premium IEEE-488 Interface Cables, 3m (10 ft)
7007-4	Double Shielded Premium IEEE-488 Interface Cables, 4m (13 ft)

Multi-Channel USB and USB/GPIB Programmable DC Power Supplies

Great accuracy is not limited to voltage; the basic current setting and readback accuracy is 0.1%, providing high quality load current measurements. Also, with less than 3mV p-p noise, the power applied to the DUT's load terminals is both accurate and of high quality.

Excellent accuracy, remote sensing, and a wide power output range make the Series 2200 Multi-Channel DC Power Supplies essential test instruments both on the bench and in test systems. Their ability to generate a wide range of output power and measure a wide range of load currents is supported with:

- Maximum output power of 45W on the 30V channels
- Maximum output power of 30W on the 6V channel
- Voltage setting and reading resolution of 1mV
- Current setting and reading resolution of 1mA

Configure the Channels to Double Output Voltage or Current or Create Bipolar Power Supplies

The two 30V channels can be combined if more than 30V or more than 1.5A is required. The two 30V outputs can be wired in series to enable an output of 60V with a maximum current output of 1.5A or can be wired in parallel to get up to 3A at 30V. In series or parallel configurations, the power supplies offer special display modes that indicate the actual voltage and current for the combined pair. It's also easy to wire the outputs to make a $\pm 30V$ bipolar supply and to maintain a user-defined ratio between the two outputs when using Tracking mode. These modes of operation extend the performance of the power supplies, while the display shows the actual outputs in these special modes to avoid any confusion or incorrect interpretation of the displayed data.

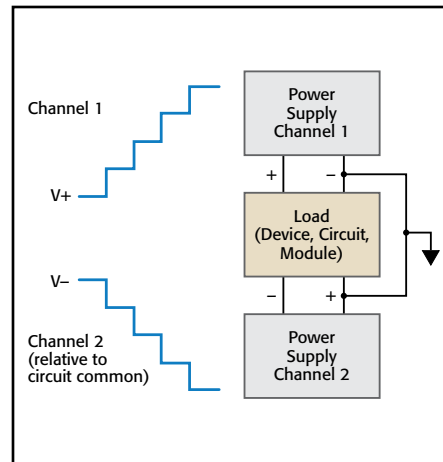

Use the two 30V channels to test a bipolar integrated circuit or a bipolar module over its specified voltage operating range.

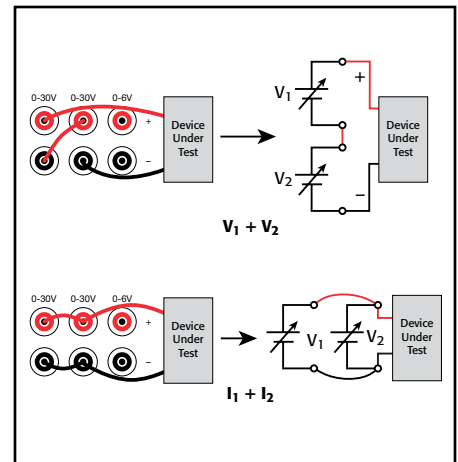

Combine two channels in series to output up to 60V or combine two channels in parallel to output up to 3A. The Model 2220/2230 display will show the combined value.

Convenience Features Help Get Results More Quickly

These multi-channel power supplies offer a number of features that return results quickly and easily:

- A rotary knob, with user-selectable step size, makes it easy to check circuit response to changing voltage or current. Alternatively, a direct-entry numeric keypad can be used to simplify setting precise voltage and current values.
- Each channel has its own readout on the display. The voltage and current being delivered to each channel are visible at a glance. A bright vacuum fluorescent display provides excellent readability at a distance, at an angle, or under dim lighting conditions.

1.888.KEITHLEY (U.S. only)

www.keithley.com

KEITHLEY

A Greater Measure of Confidence

A Tektronix Company

2220, 2220G, 2230, 2230G

Multi-Channel USB and USB/GPIB Programmable DC Power Supplies

- To save time when repeating tests, instrument settings can be saved in one of 30 internal memory locations by simply pressing the Save button. To recall that setting, just push the Recall button, and choose the desired setup.

Protection for Your Device-Under-Test

These multi-channel power supplies include maximum voltage settings that prevent voltage from being accidentally adjusted above user-specified limits. Independent outputs allow a different limit to be specified for each output channel. With the numeric keypad, a current limit can be quickly and precisely specified before a test is started. In addition, a user-definable password allows the front panel to be locked to prevent unwanted adjustment during critical tests.

Easy Test Automation

Two interface choices are available to enable PC control from a user-preferred programming environment. A USB TMC-compliant device port is included on all versions of these power supplies. The "G" versions add the GPIB interface for the flexibility of either USB or GPIB control. LabView and IVI drivers are provided to facilitate instrument control, data logging, and analysis. With these drivers, the power supplies can be controlled from most commercially-available software packages such as MatLab. Thus, these power supplies can be controlled as a single unit or as part of an automated test system.

APPLICATIONS

Typical applications include:

- Circuit design
- Electrical engineering student labs
- Materials research
- Automated test

SERVICES AVAILABLE

<i>Model Number</i> *-EW	1 additional year of factory warranty
<i>Model Number</i> -5Y-EW	2 additional years of factory warranty beyond the standard 3-year warranty
<i>C/Model Number</i> -3Y-STD	3 calibrations within 3 years of purchase
<i>C/Model Number</i> -3Y-DATA	3 (ANSI-Z540-1 compliant) calibrations within 3 years of purchase
<i>C/Model Number</i> -5Y-STD	5 calibrations within 5 years of purchase
<i>C/Model Number</i> -5Y-DATA	5 (ANSI-Z540-1 compliant) calibrations within 5 years of purchase

* Replace "Model Number" with a power supply model number. For example: if the 2230GJ-30-1 is selected, then the part number for the -EW, one year of additional warranty option, is 2230GJ-30-1-EW.

NOTE: the "J" versions truncate the "A" in DATA. Example: C/222GJ-30-1-3Y-DAT

Specifications

	2230-30-1, 2230J-30-1, 2230G-30-1, 2230GJ-30-1			2220-30-1, 2220J-30-1, 2220G-30-1, 2220GJ-30-1	
DC OUTPUT RATING					
Voltage	0 to 30 V	0 to 30 V	0 to 6 V	0 to 30 V	0 to 30 V
Current	0 to 1.5 A	0 to 1.5 A	0 to 5 A	0 to 1.5 A	0 to 1.5 A
MAXIMUM POWER					
	120 W			90 W	
LOAD REGULATION					
Voltage	< 0.01% + 3 mV	< 0.01% + 3 mV	< 0.01% + 3 mV	< 0.01% + 3 mV	< 0.01% + 3 mV
Current	< 0.01% + 3 mA	< 0.01% + 3 mA	< 0.01% + 3 mA	< 0.01% + 3 mA	< 0.01% + 3 mA
LINE REGULATION					
Voltage	< 0.01% + 3 mV	< 0.01% + 3 mV	< 0.01% + 3 mV	< 0.01% + 3 mV	< 0.01% + 3 mV
Current	< 0.1% + 3 mA	< 0.1% + 3 mA	< 0.1% + 3 mA	< 0.1% + 3 mA	< 0.1% + 3 mA
RIPPLE AND NOISE					
Voltage (7MHz)	< 1 mV rms < 3 mV p-p	< 1 mV rms < 3 mV p-p	< 1 mV rms < 3 mV p-p	< 1 mV rms < 3 mV p-p	< 1 mV rms < 3 mV p-p
Current (20MHz)	< 5 mA rms	< 5 mA rms	< 6 mA rms	< 5 mA rms	< 5 mA rms
SETTING RESOLUTION					
Voltage	1 mV	1 mV	1 mV	1 mV	1 mV
Current	1 mA	1 mA	1 mA	1 mA	1 mA
SETTING ACCURACY					
Voltage	± 0.03% + 10 mV	± 0.03% + 10 mV	± 0.03% + 10 mV	± 0.03% + 10 mV	± 0.03% + 10 mV
Current	± 0.1% + 5 mA	± 0.1% + 5 mA	± 0.1% + 5 mA	± 0.1% + 5 mA	± 0.1% + 5 mA
METER RESOLUTION					
Voltage	1 mV	1 mV	1 mV	1 mV	1 mV
Current	1 mA	1 mA	1 mA	1 mA	1 mA
METER ACCURACY					
Voltage	± 0.03% + 10 mV	± 0.03% + 10 mV	± 0.03% + 10 mV	± 0.03% + 10 mV	± 0.03% + 10 mV
Current	± 0.1% + 5 mA	± 0.1% + 5 mA	± 0.1% + 5 mA	± 0.1% + 5 mA	± 0.1% + 5 mA

ISOLATION VOLTAGE, OUTPUT TO CHASSIS: Any output can be floated up to 240V (DC + peak AC with AC limited to a maximum of 3Vpk-pk and a maximum frequency of 60Hz) relative to earth ground terminal.

ISOLATION VOLTAGE, OUTPUT TO OUTPUT: Any output can be floated up to 240V (DC + peak AC with AC limited to a maximum of 3Vpk-pk and a maximum frequency of 60Hz) relative to any other output terminal.

VOLTAGE TRANSIENT RESPONSE SETTling TIME, LOAD CHANGE (typical): <150ms to within 75mV following a change from 0.1A to 1A.

VOLTAGE TRANSIENT RESPONSE SETTling TIME, SETTING CHANGE, RISING (typical): <150ms to within 75mV following a change from 1V to 11V into a 10Ω resistor (Ch. 1, 2); from 0.4V to 4V into a 4Ω resistor (ch. 3.)

VOLTAGE TRANSIENT RESPONSE SETTling TIME, SETTING CHANGE, FALLING (typical): <150ms to within 75mV following a change from 11V to 1V into a 10Ω resistor (Ch. 1, 2); from 0.4V to 4V into a 4Ω resistor (ch. 3.)

DISPLAY: Vacuum fluorescent display.

MEMORY: 30 setup memories.

TRACKING AND COMBINATION MODES:

Tracking Mode: Maintains the ratio on the two 30V output channels that is present when the control is activated.

Combination V1+V2 Series Mode: Deliver up to 60 V when CH1 and CH2 are wired in series. Meter reads back combined voltage.

Combination I1+I2 Parallel Mode: Deliver up to 3 A when CH1 and CH2 are wired in parallel. Meter reads back combined current.

REAR PANEL CONNECTIONS: USB Device Port, Type B connector, USBTMC compatible. 2220G and 2230G versions include a GPIB interface, IEEE-488.2 compliant.

POWER SOURCE

AC INPUT: Non-"J" versions: Switchable between 120VAC or 240VAC, nominal (different fuse required for each voltage).

"J" Versions: 100VAC, nominal.

FREQUENCY: 50/60Hz

POWER CONSUMPTION:

Dual Channel Versions: 350VA.

Triple Channel Versions: 450VA.

PHYSICAL CHARACTERISTICS

PROTECTIVE BOOTS AND HANDLE INSTALLED:

Height: 105.3mm (4.15 in.)

Width: 241.8mm (9.52 in.)

Depth: 384.0mm (15.12 in.)

PROTECTIVE BOOTS AND HANDLE REMOVED:

Height: 90.7mm (3.57 in.)

Width: 217.2mm (8.55 in.)

Depth: 361.6mm (14.24 in.)

NET WEIGHT:

2220-30-1: 8.2 kg (18 lb.)

2230-30-1: 8.5 kg (19 lb.)

SHIPPING WEIGHT:

2220-30-1: 11 kg (24 lb.)

2230-30-1: 11 kg (24 lb.)

1.888.KEITHLEY (U.S. only)

www.keithley.com

A Greater Measure of Confidence

KEITHLEY

A Tektronix Company

2220, 2220G, 2230, 2230G

Multi-Channel USB and USB/GPIB Programmable DC Power Supplies

ENVIRONMENTAL AND SAFETY

Temperature: **Operating:** 0° to +40°C.
Storage: -20° to +70°C.

Relative Humidity (non-condensing):

Operating: 5% to 95% relative humidity at up to +40°C.

Storage: 5% to 95% relative humidity at up to +40°C. 5% to 60% RH above +40°C up to +70°C, non condensing.

Altitude:

Operating: Up to 2000m.

Storage: Up to 4000m.

Safety:

European Union: Complies with European Union EMC Directive.

USA: Nationally recognized testing laboratory listing UL61010-1-2004.

Canada: CAN/CSA C22.2 No. 61010-1 2004.

ELECTROMAGNETIC COMPATIBILITY

European Union: Complies with European Union Low Voltage Directive.

Australia: EMC Framework, demonstrated per Emission Standard AS/NZS 2064 (Industrial, Scientific, and Medical Equipment).



Model 2220-30-1 rear panel. The Model 2220G-30-1 adds a GPIB connector.

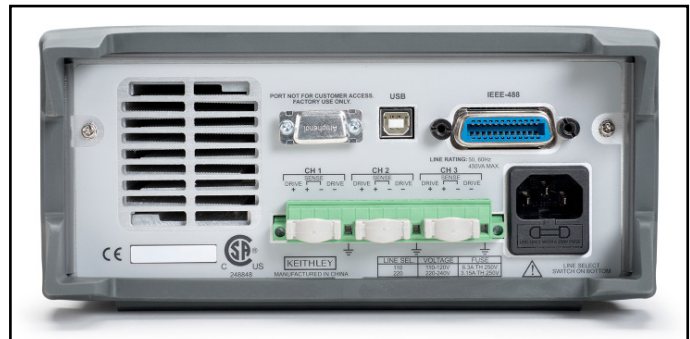

Model 2230G-30-1 rear panel. The Model 2230-30-1 does not have the GPIB connector.

Specifications are subject to change without notice. All Keithley trademarks and trade names are the property of Keithley Instruments, Inc. All other trademarks and trade names are the property of their respective companies.

KEITHLEY

A Tektronix Company

A Greater Measure of Confidence

KEITHLEY INSTRUMENTS, INC. ■ 28775 AURORA RD. ■ CLEVELAND, OH 44139-1891 ■ 440-248-0400 ■ Fax: 440-248-6168 ■ 1-888-KEITHLEY ■ www.keithley.com

BENELUX
+31-40-267-5506
www.keithley.nl

FRANCE
+33-01-69-86-83-60
www.keithley.fr

ITALY
+39-049-762-3950
www.keithley.it

MALAYSIA
60-4-643-9679
www.keithley.com

SINGAPORE
01-800-8255-2835
www.keithley.com.sg

BRAZIL
55-11-4058-0229
www.keithley.com

GERMANY
+49-89-84-93-07-40
www.keithley.de

JAPAN
81-120-441-046
www.keithley.jp

MEXICO
52-55-5424-7907
www.keithley.com

TAIWAN
886-3-572-9077
www.keithley.com.tw

CHINA
86-10-8447-5556
www.keithley.com.cn

INDIA
080-30792600
www.keithley.in

KOREA
82-2-6917-5000
www.keithley.co.kr

RUSSIA
+7-495-664-7564
www.keithley.ru

UNITED KINGDOM
+44-1344-39-2450
www.keithley.co.uk

For further information on how to purchase or to locate a sales partner please visit www.keithley.com/company/buy