



Product information CM 06 EA 14S-6 S

Industrial Connecting Solutions: Circular Connectors: MIL, DIN, Universal Connectors: MIL-C-5015 or VG 95342 Connectors (CM series): Cable socket: CM 06 EA 14S-6 S

<https://www.e-catalog.beldensolutions.com:443/link/57078-24228-256281-256284-24363-24364-36144/en/conf/ui/state>

Name	CM 06 EA 14S-6 S
	
	Straight cable socket, strain relief by means of a clamp
Delivery informations	
Availability	available
Product description	
Description	Straight cable socket, strain relief by means of a clamp
Type	CM 06 EA 14S-6 S
Order No.	932 458-100
Number of contacts	6
Cable gland	PG 11
Cable diameter	8 mm to 10 mm
Conductor size	max. 1 mm ²
Standard	MIL-C 5015 bzw. VG 95 342
Housing Color	black
Technical data	
Pin dimensions	1.6 mm
Rated voltage	AC/DC 50 V
Rated current	10 A
Contact resistance	<= 5 mOhm
Type of termination	solder
Shell size	14S
Material	
Contact surface material	Ag
Contact bearer material	PA 66-GF 25
Housing material	PA 66-GF 25
O-Ring	NBR
Environmental conditions	
Protection class (IEC 60529)	IP 67
Pollution severity	3
Temperature range	-40 °C to +90 °C
Inflammability class	
Flammability, UL standard	94 V-1
Packing unit	
Packaging unit	100 pieces
Scope of delivery and accessories	
Scope of delivery	1 cable socket, not assembled, assembly instructions
Accessories to order separately	can be plugged into CM 02 E 14S-6 P; cap CM 06 SD 14S, order no. 831 621-100

Picture
Drawing

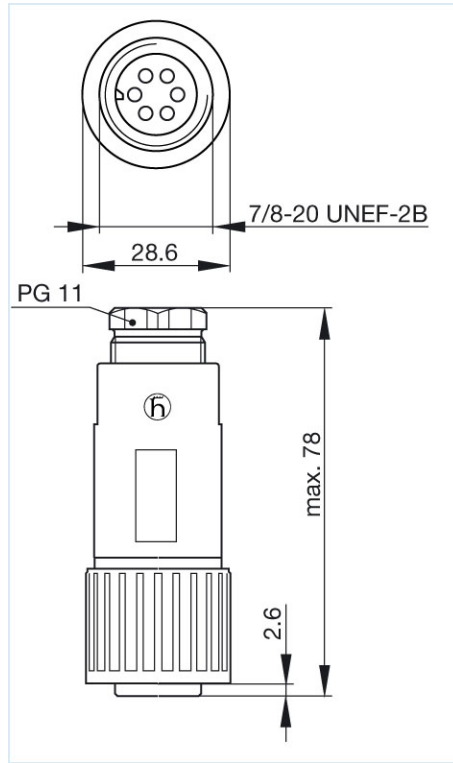

Belden Deutschland GmbH
Im Gewerbepark 2
58579 Schalksmühle
Germany
Phone: +49 7127/14-1806
E-Mail: icos-sales@belden.com

The information published in the websites has been compiled as carefully as possible. It is subject to alteration without notice in technical as well as in price-related/commercial respect. The complete information and data were available on user documentation. Mandatory information can only be obtained by a concrete query.