



Prestigio

THE ART OF HI-TECH



Car Video Recorder

RoadRunner 133

User Manual

Version 1.0

www.prestigio.com

About this user manual

This user manual is specially designed to detail the device's functions and features.

- Please read this manual before using the device to ensure safe and proper use.
- Descriptions are based on the device's default settings.
- Prestigio continuously strives to improve its products. Due to software upgrading, some contents in this user manual may be different from your product. Prestigio reserves the rights to revise this user manual or withdraw it at any time without prior notice. Please take your product as standard.

Conventions used in this manual

In this user manual, we use the following symbols to indicate useful and important information:



Caution: provides safety precaution and important information.



Note: gives additional information.



Tips: usage tips.

- > The order of options or menus you must select to perform a step.

Contents

1. Unboxing	1
Inside your package	1
Device overview	1
2. Getting started.....	2
Insert a microSD card	2
Install the 3M mount	2
Charge the battery	2
3. Settings.....	3
Video settings.....	3
Picture settings.....	3
General settings	3
4. Recording.....	4
Record a video	4
Take a picture.....	4
Record a sound	4
5. File management	4
Browse files	4
Delete a file	4
Lock and unlock a file	4
6. Playback.....	5
Play video on DVR	5
Playback on PC	5
7. Specifications	5

1. Unboxing



Inside your package

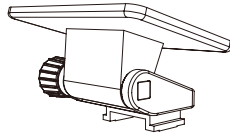
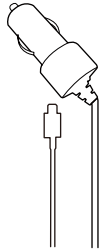
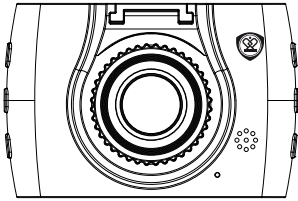

- Car video recorder
- 3M mount

- Car charger
- Quick start guide

Device overview

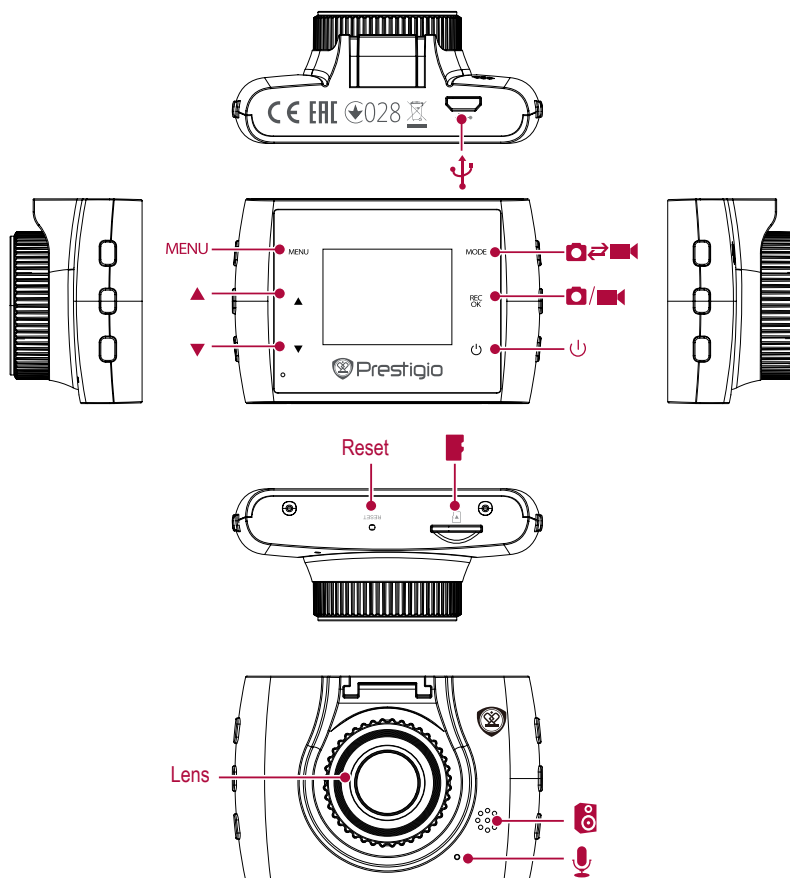

2. Getting started

2

Insert a microSD card

Before starting video recording, please insert a microSD card (not included) into the slot until it locks in place.

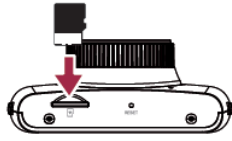

The device will automatically recognize it as default storage and all the data will be saved on this card.

Install 3M mount

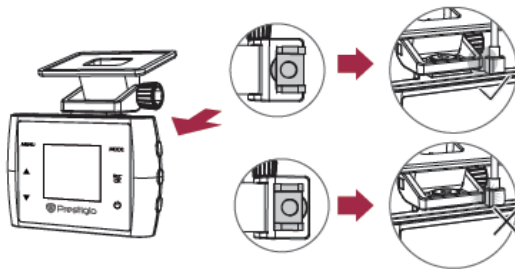

1. Follow the arrow pointing direction to insert the 3M mount and lock the device into its holder
2. Remove the protection paper from the 3M mount, and position the device on the clean windshield or dashboard.

Charge the battery

Before using the device for the first time, please fully charge the Li-ion battery. The battery will be completely charged in 1-2 hours.

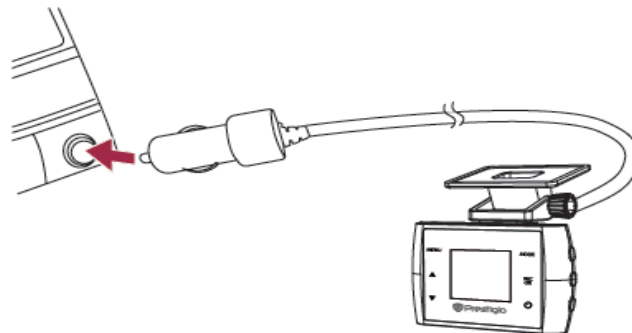

- Using the car charger: charge the device through cigarette lighter. The device will start charging after the car engine is turned on.
- Using micro USB cable: connect the device to AC 5V adapter or the USB port of a computer/laptop.

3. Settings



Before recording, you can set up the device according to your requirements.

- In video/picture preview mode, press [MENU] to enter video/picture settings, press it again go the general settings, press it third time to exit.
- In setting list, use [▲]/[▼] to navigate the menu, press [OK] to get the options and confirm the selection, press [MENU] to exit.

Video settings

- **Resolution:** Select the resolution of recorded video: 720P / 1280 x 720, VGA / 640 x 480
- **Date stamp:** Add date and time stamp onto videos.
- **Motion detection:** Turn on or off motion detection. If there is any motion detected while the car engine is stopped, your car DVR will start recording automatically.
- **Loop recording:** Set the video duration (1, 3, 5, 10 minutes or off) for loop recording. When the microSD card is full, the device will delete the oldest unlocked video file automatically.

Picture settings

- **Size:** Select the picture image size from 3M, 2M, 1.3M, VGA.

General settings

In preview mode, press [MENU] twice to enter general settings.

- **Format:** Format the memory card.



Formatting will erase all your stored data. Back up your data before proceeding.

- **Language:** Choose your language.
- **Power off:** Set automatic power off when the device is not in use.
- **Default:** Restore to default settings.
- **Frequency:** For a given luminance, the frequency of light fluctuation that evokes a sensation of flicker. Set a right flickering frequency to avoid horizontal stripe interference.
- **Date/Time:** Set date and time on device.
- **Version:** Display the current system version.

4. Recording

4

Record a video

Auto video recording

Connect the device to car charger, when the car engine launches, the device will automatically turn on and start loop video recording. When shut off the car engine, the device will save the last file and turn off.

Manual video recording

In video preview mode, press [OK] button to start and stop video recording.

Record the sound

In preview mode or recording mode, press [▲] to turn on or off the sound.

Lock a recording video

During recording, press [MODE] to lock the video.

Take a picture

Press [MODE] to select the picture mode, and then press [OK] to take photos.

5. File management

5

You can manage your videos and pictures in playback mode.

Browse files

1. In video preview mode, press [MODE] two times to enter the playback mode.
2. Press [▲]/[▼] to scroll through the files.

Delete a file

Press [MENU] to delete one file or all the files, and press [OK] to confirm the deletion.



To delete a protected file, remove the protection first.

Lock and unlock a file

Press [MENU] to protect or unprotect the selected file or all.

6. Playback



Play video on DVR

1. In playback mode, press [▲]/[▼] to scroll through the files.
2. Press [OK] to start/Pause playback.
3. Press [MODE] to stop playing.
4. Press [MENU] again to exit playback mode.

Playback on PC

Remove memory card from DVR and insert it into computer's card reader.



DVR's USB port is for charging purpose only.

7. Specifications

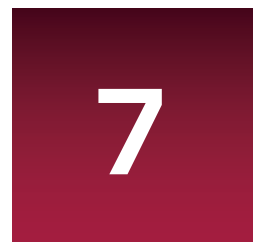

Display	1.5", 480 x 240 pixels
Processor	GP6624
Image sensor	0.3 MP CMOS Sensor (GC0308)
View angle	100°
Video resolution	HD 1280x720@30fps(interpolated), VGA 640x480@30fps
Photo resolution	3 MP (Interpolated)
Video codec	AVI
Picture format	JPG
Memory	up to 32 GB (high-speed SD card recommended, SDHC)
Microphone	Built-in
Motion Detection	Yes
Power source	Detachable rechargeable battery 150 mAh, car charger
Interfaces	Micro USB (for charging only)
Operating temperature	0 °C ~ 45°C
Dimension	71 x 47 x 31 mm (L x W x H)
Weight	43.7 g