

Analog Devices Welcomes Hittite Microwave Corporation

NO CONTENT ON THE ATTACHED DOCUMENT HAS CHANGED



HMC684* Product Page Quick Links

Last Content Update: 08/30/2016

[Comparable Parts](#)

View a parametric search of comparable parts

[Evaluation Kits](#)

- HMC684LP4 Evaluation Board

[Documentation](#)

Data Sheet

- HMC684 Data Sheet

[Reference Materials](#)

Quality Documentation

- Package/Assembly Qualification Test Report: LP4, LP4B, LP4C, LP4K (QTR: 2013-00487 REV: 04)
- Semiconductor Qualification Test Report: BiCMOS-A (QTR: 2013-00235)

[Design Resources](#)

- HMC684 Material Declaration
- PCN-PDN Information
- Quality And Reliability
- Symbols and Footprints

[Discussions](#)

View all HMC684 EngineerZone Discussions

[Sample and Buy](#)

Visit the product page to see pricing options

[Technical Support](#)

Submit a technical question or find your regional support number

THIS PAGE INTENTIONALLY LEFT BLANK

Typical Applications

The HMC684LP4(E) is Ideal for:

- Cellular/3G & LTE/WiMAX/4G
- Basestations & Repeaters
- GSM, CDMA & OFDM
- Transmitters and Receivers

Features

- High Input IP3: +32 dBm
- Low Conversion Loss: 7 dB
- Low LO Drive: 0 dBm
- Upconversion & Downconversion Applications
- 24 Lead 4x4mm SMT Package: 16mm²

Functional Diagram

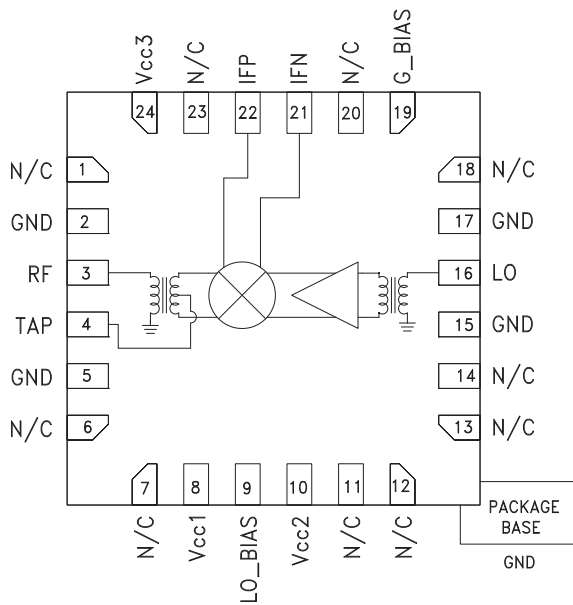

General Description

The HMC684LP4(E) is a high dynamic range passive MMIC mixer with integrated LO amplifier in a 4x4 SMT QFN package covering 0.7 to 1.0 GHz. Excellent input IP3 performance of +32 dBm for down conversion is provided for 3G & 4G GSM/CDMA applications at an LO drive of 0 dBm. With an input 1 dB compression of +25 dBm, the RF port will accept a wide range of input signal levels. Conversion loss is 7 dB typical. The DC to 450 MHz IF frequency response will satisfy GSM/CDMA transmit or receive frequency plans. The HMC684LP4(E) is pin for pin compatible with the HMC685LP4(E) which is a 1.7 - 2.2 GHz mixer with LO amplifier.

Electrical Specifications

$T_A = +25^\circ C$, $IF = 100 MHz$, $LO = 0 dBm$, $V_{cc1, 2, 3} = +5V$, $G_{Bias} = +3.5V^*$

Parameter	Min.	Typ.	Max.	Units
Frequency Range, RF		0.7 - 1.0		GHz
Frequency Range, LO		0.6 - 1.0		GHz
Frequency Range, IF		DC to 450		MHz
Conversion Loss		7	9	dB
Noise Figure (SSB)		7		dB
LO to RF Isolation	17	23		dB
LO to IF Isolation	20	30		dB
RF to IF Isolation	25	35		dB
IP3 (Input)		32		dBm
1 dB Compression (Input)		25		dBm
LO Drive Input Level (Typical)		-6 to +3		dBm
Supply Current Icc Total		85	100	mA

* Unless otherwise noted all measurements performed as downconverter with low side LO & IF = 100 MHz.

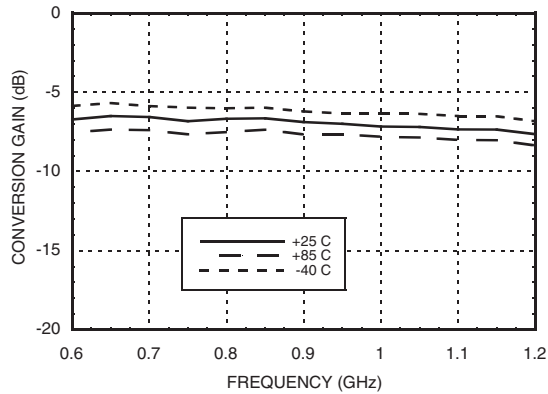
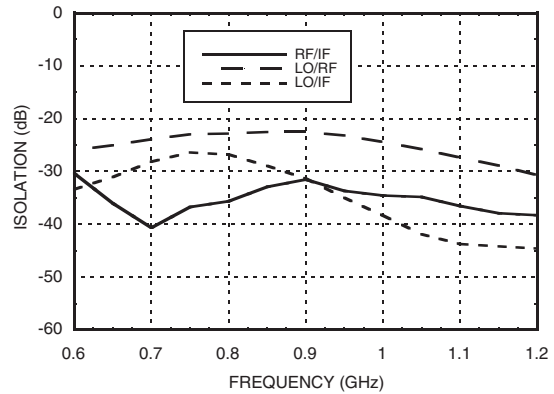
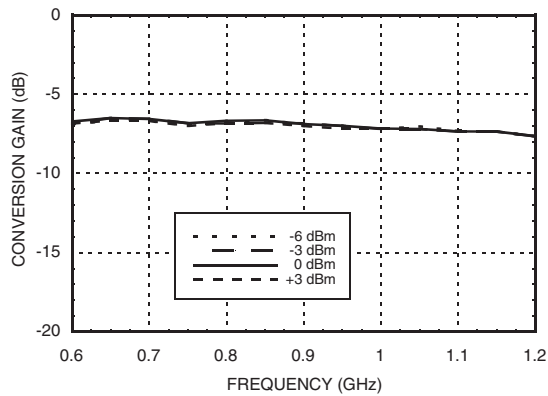
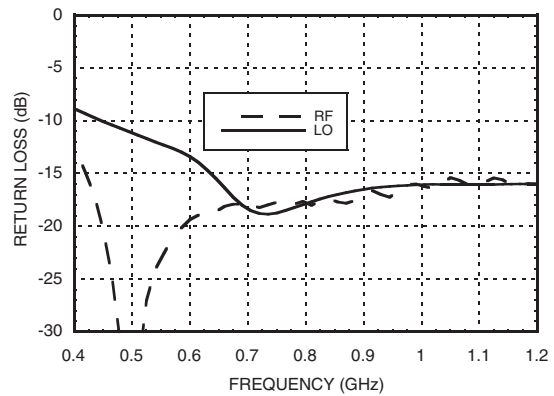
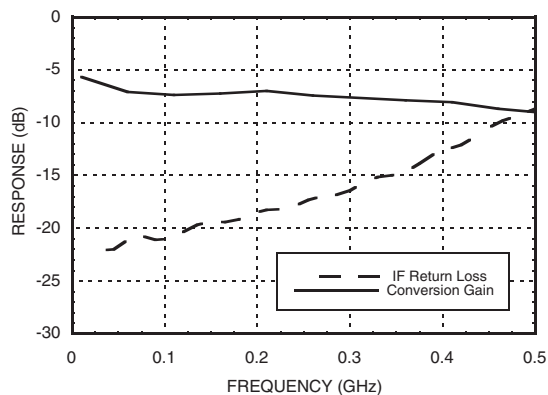
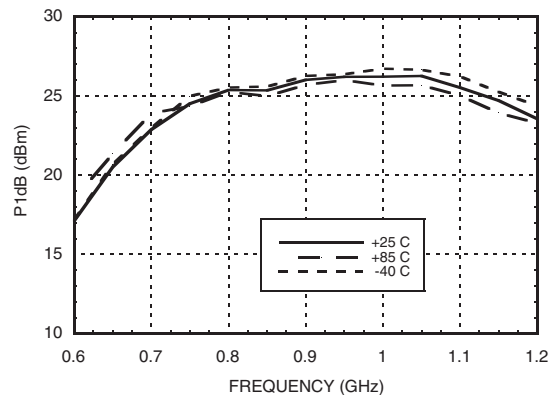
Conversion Gain vs. Temperature

Isolation

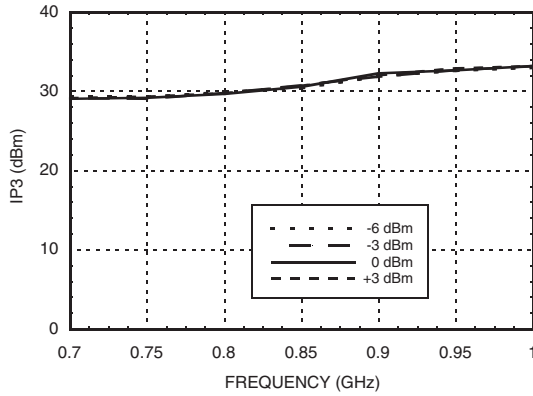
Conversion Gain vs. LO Drive

Return Loss

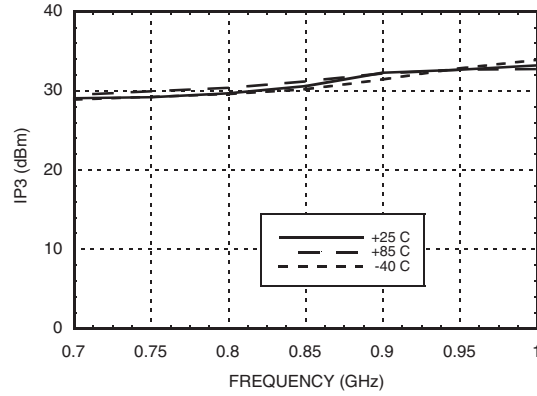
IF Bandwidth (LO = 0.8 GHz)

Input P1dB vs. Temperature

Input IP3 vs. LO Drive ^[1]



Input IP3 vs. Temperature ^[1]



+2RF -2LO Response vs. Temperature ^[2]

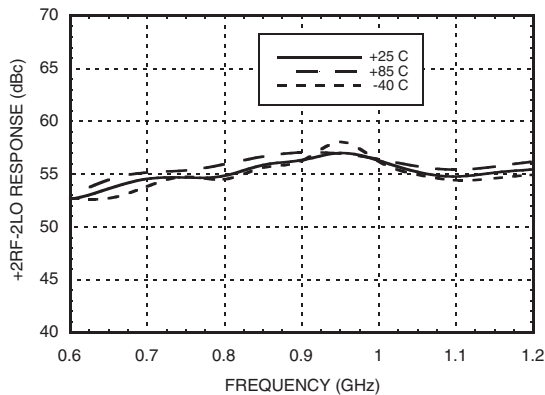

+2RF -2LO Response vs. LO Drive ^[2]

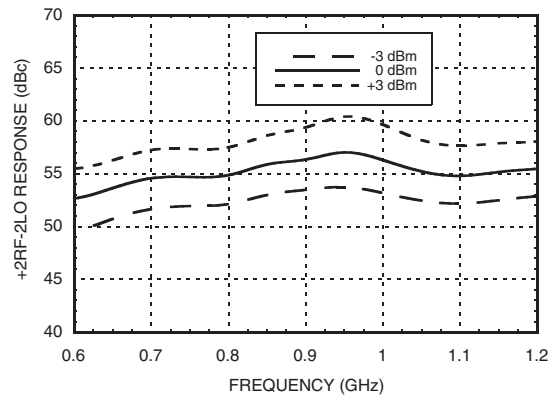

+3RF -3LO Response vs. Temperature ^[2]

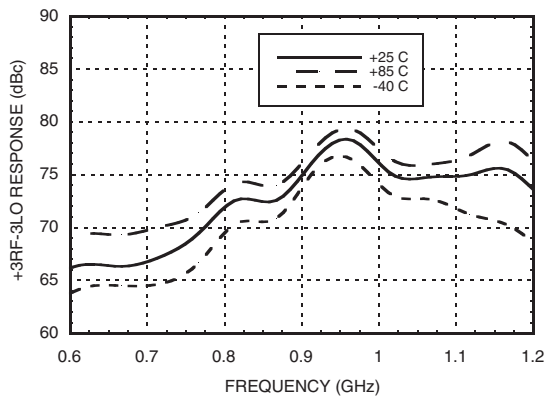

+3RF -3LO Response vs. LO Drive ^[2]

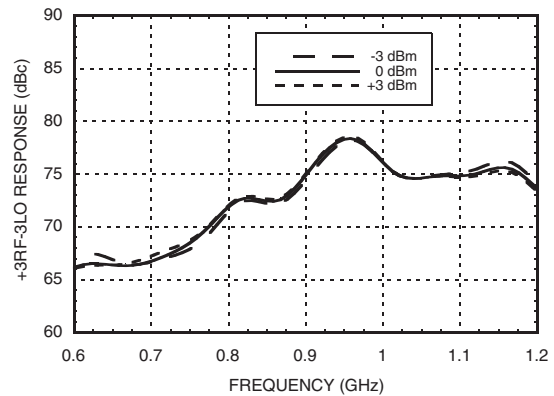

[1] Two-tone input power = +9 dBm each tone, 1 MHz spacing. [2] Reference to RF Power at 0 dBm



BiCMOS MMIC MIXER W/ INTEGRATED LO AMPLIFIER, 700 - 1000 MHz

Upconverter Performance Conversion Gain vs. LO Drive

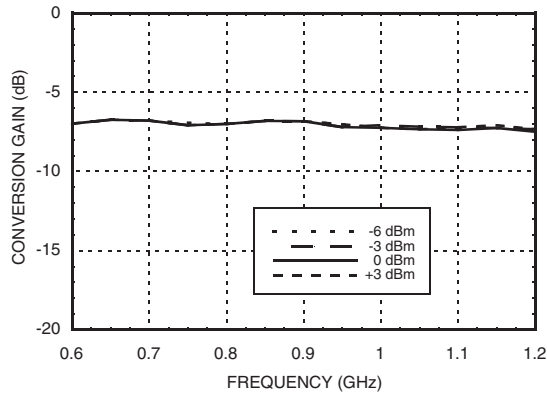

Upconverter Performance Input IP3 vs. LO Drive

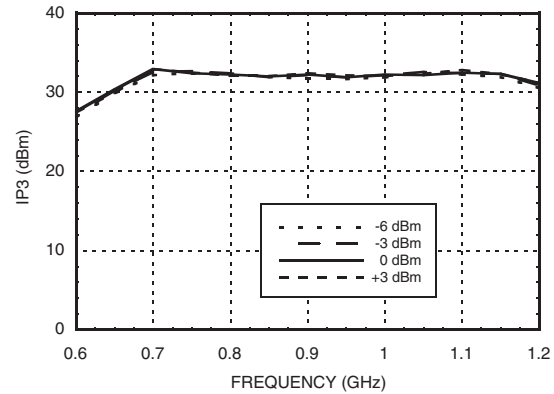

Absolute Maximum Ratings

RF / IF Input (Vcc1 - 3 = +5V)	+26 dBm
LO Drive (Vcc = +5V)	+10 dBm
Vcc1 - 3 (LO or IF)	5.5V
Channel Temperature	125 °C
Continuous Pdiss (T = 85°C) (derate 17.24 mW/°C above 85°C)	0.69W
Thermal Resistance (channel to ground paddle)	58 °C/W
Storage Temperature	-65 to 150 °C
Operating Temperature	-40 to +85 °C
ESD Sensitivity (HBM)	Class 1A

MxN Spurious @ IF Port

mRF	nLO				
	0	1	2	3	4
0	xx	25	16	25	31
1	25	0	25	17	35
2	52	47	50	55	58
3	82	73	92	70	77
4	112	100	112	110	98

RF Freq. = 0.9 GHz @ 0 dBm
LO Freq. = 0.8 GHz @ 0 dBm
All values in dBc below IF power level (1RF - 1LO).



ELECTROSTATIC SENSITIVE DEVICE
OBSERVE HANDLING PRECAUTIONS

Typical Supply Current vs. Vcc

Vcc1 - 3 (V)	Icc Total (mA)
4.75	80
5.00	85
5.25	90

Product will operate over full voltage range shown above.

Harmonics of LO

LO Freq. (GHz)	nLO Spur @ RF Port			
	1	2	3	4
0.5	26	45	36	43
0.6	24	43	35	36
0.7	22	30	41	30
0.8	22	30	34	28
0.9	24	31	37	31
1	27	32	37	44
1.1	31	28	45	30

LO = 0 dBm
All values in dBc below input LO level measured at RF port

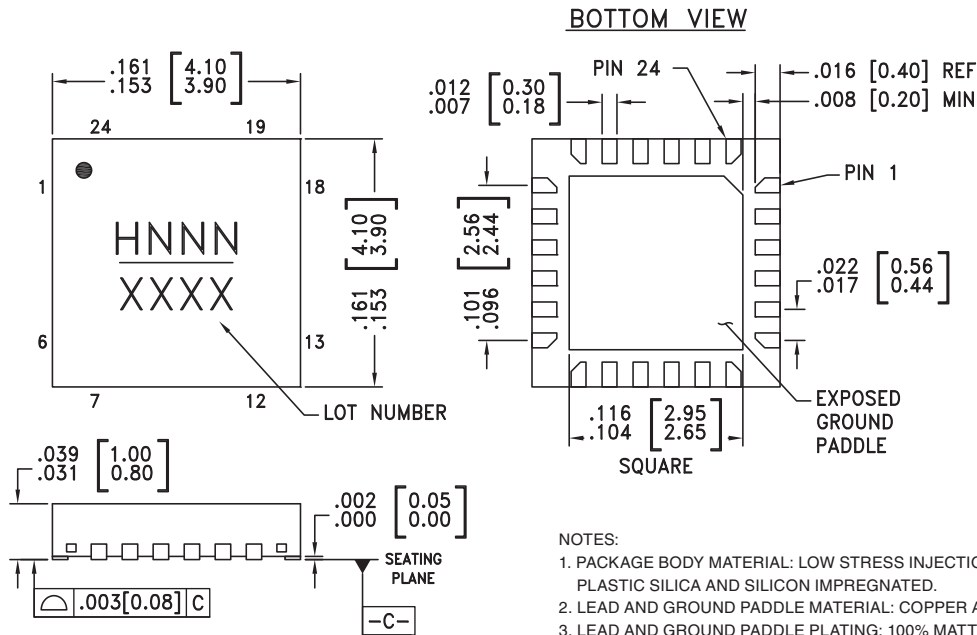
Outline Drawing

Package Information

Part Number	Package Body Material	Lead Finish	MSL Rating	Package Marking ^[3]
HMC684LP4	Low Stress Injection Molded Plastic	Sn/Pb Solder	MSL1 ^[1]	H684 XXXX
HMC684LP4E	RoHS-compliant Low Stress Injection Molded Plastic	100% matte Sn	MSL1 ^[2]	H684 XXXX

[1] Max peak reflow temperature of 235 °C

[2] Max peak reflow temperature of 260 °C

[3] 4-Digit lot number XXXX

Pin Descriptions

Pin Number	Function	Description	Interface Schematic
1, 6, 7, 11 - 14, 18, 20, 23	N/C	No connection. These pins may be connected to RF ground. Performance will not be affected.	
2, 5, 15, 17	GND	Package bottom must be connected to RF/DC ground.	
3	RF	This pin is matched single-ended 50 Ohm and DC shorted to ground through a balun.	
4	TAP	Center tap of secondary side of the internal RF balun. Short to ground with a zero ohm close to the package.	
8, 10, 24	Vcc1, Vcc2, Vcc3	Power supply voltage. See application circuit for required external components.	
9	LO_BIAS	Adjust the LO buffer current through an external resistor. See application circuit for required external components.	
16	LO	This pin is matched single-ended 50 Ohm and DC shorted to ground through a balun.	
19	G_BIAS	External optional bias. See application circuit for required external components.	
21, 22	IFN, IFP	Differential IF input / output pins matched to differential 50 Ohms. For applications not requiring operation to DC an off chip DC blocking capacitor should be used.	

Evaluation PCB

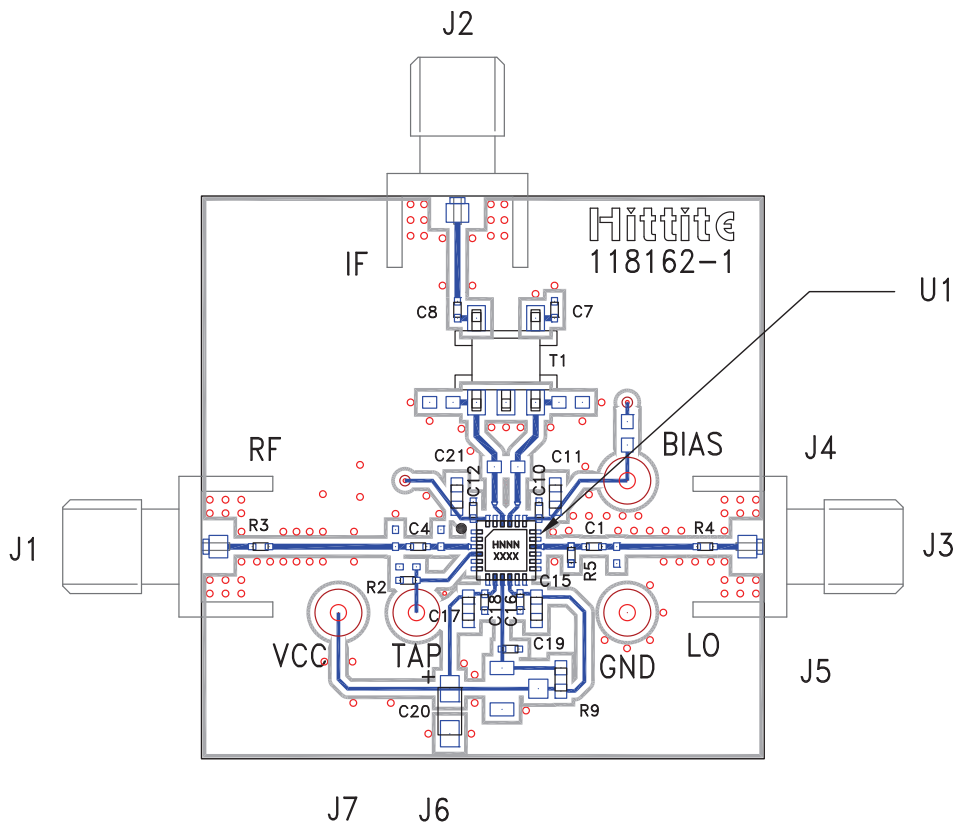

List of Materials for Evaluation PCB 119920 [1]

Item	Description
J1 - J3	SMA Connector
J4 - J7	DC Pin
C1, C19	22 pF Capacitor, 0402 Pkg.
C4	6.8 pF Capacitor, 0402 Pkg.
C7, C8	10 nF Capacitor, 0402 Pkg.
C10, C12, C16, C18	1 nF Capacitor, 0402 Pkg.
C11, C15, C17, C21	0.1 μF Capacitor, 0603 Pkg.
C20	4.7 μF Case A, Tantalum
R2 - R4	0 Ohm Resistor, 0402 Pkg.
R5	68 Ohm Resistor, 0402 Pkg.
R9	390 Ohm Resistor, 0603 Pkg.
T1	1:1 Transformer - Tyco MABACT0039
U1	HMC684LP4(E) Downconverter
PCB [2]	118162 Evaluation PCB

The circuit board used in the application should use RF circuit design techniques. Signal lines should have 50 Ohm impedance while the package ground leads and exposed paddle should be connected directly to the ground plane similar to that shown. A sufficient number of via holes should be used to connect the top and bottom ground planes. The evaluation circuit board shown is available from Hittite upon request.

[1] Reference this number when ordering complete evaluation PCB

[2] Circuit Board Material: Arlon 25R, FR4

Application Circuit

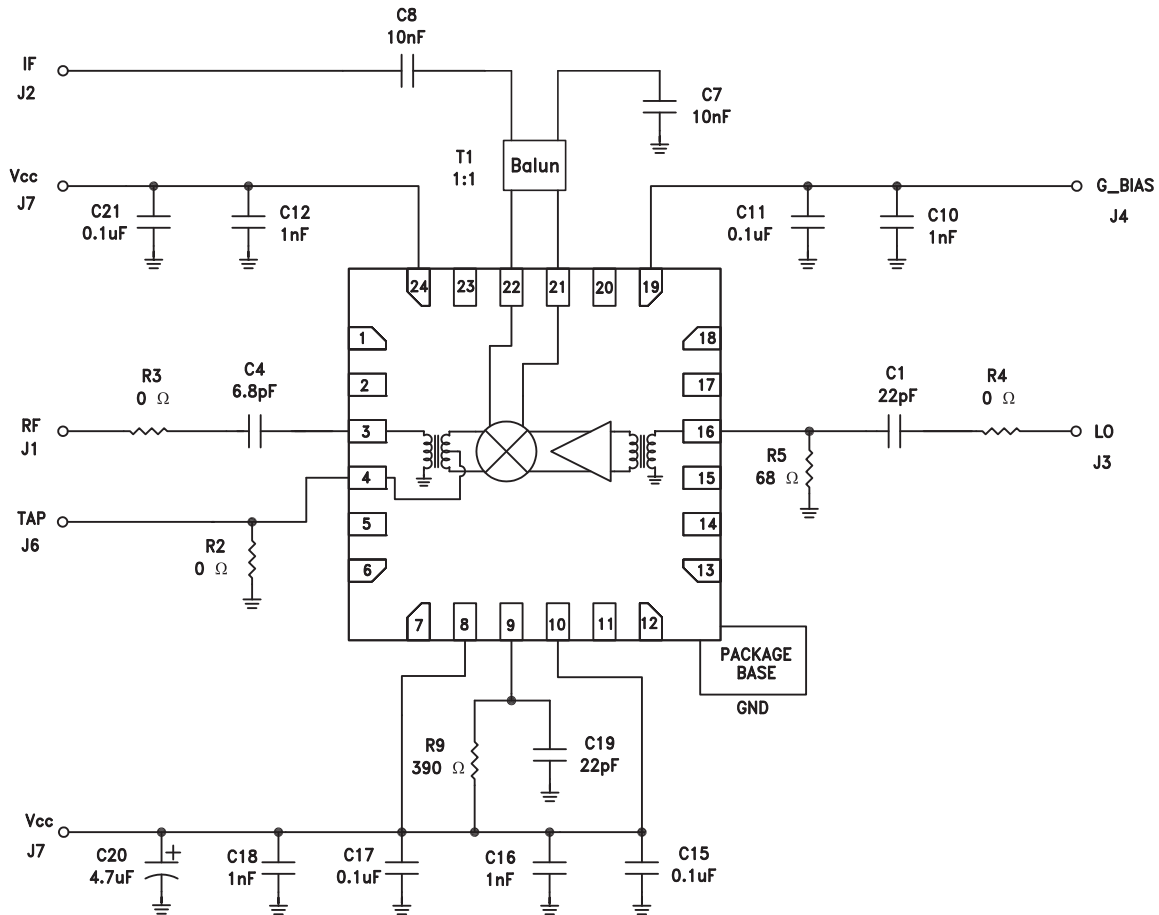

10

MIXERS - SINGLE & DOUBLE BALANCED - SMT