



Is Now Part of



ON Semiconductor®

To learn more about ON Semiconductor, please visit our website at
www.onsemi.com

ON Semiconductor and the ON Semiconductor logo are trademarks of Semiconductor Components Industries, LLC dba ON Semiconductor or its subsidiaries in the United States and/or other countries. ON Semiconductor owns the rights to a number of patents, trademarks, copyrights, trade secrets, and other intellectual property. A listing of ON Semiconductor's product/patent coverage may be accessed at www.onsemi.com/site/pdf/Patent-Marking.pdf. ON Semiconductor reserves the right to make changes without further notice to any products herein. ON Semiconductor makes no warranty, representation or guarantee regarding the suitability of its products for any particular purpose, nor does ON Semiconductor assume any liability arising out of the application or use of any product or circuit, and specifically disclaims any and all liability, including without limitation special, consequential or incidental damages. Buyer is responsible for its products and applications using ON Semiconductor products, including compliance with all laws, regulations and safety requirements or standards, regardless of any support or applications information provided by ON Semiconductor. "Typical" parameters which may be provided in ON Semiconductor data sheets and/or specifications can and do vary in different applications and actual performance may vary over time. All operating parameters, including "Typicals" must be validated for each customer application by customer's technical experts. ON Semiconductor does not convey any license under its patent rights nor the rights of others. ON Semiconductor products are not designed, intended, or authorized for use as a critical component in life support systems or any FDA Class 3 medical devices or medical devices with a same or similar classification in a foreign jurisdiction or any devices intended for implantation in the human body. Should Buyer purchase or use ON Semiconductor products for any such unintended or unauthorized application, Buyer shall indemnify and hold ON Semiconductor and its officers, employees, subsidiaries, affiliates, and distributors harmless against all claims, costs, damages, and expenses, and reasonable attorney fees arising out of, directly or indirectly, any claim of personal injury or death associated with such unintended or unauthorized use, even if such claim alleges that ON Semiconductor was negligent regarding the design or manufacture of the part. ON Semiconductor is an Equal Opportunity/Affirmative Action Employer. This literature is subject to all applicable copyright laws and is not for resale in any manner.

KA278RXXC-Series

2 A Output Low Dropout Voltage Regulators

Features

KA278RXXC-Series (33 / 05 / 12)

- 3.3 V, 5 V, 12 V Output Low-Dropout Voltage Regulator
- TO-220 Full-Mold Package (4 Pin)
- Over-Current Protection, Thermal Shutdown
- Over-Voltage Protection, Short-Circuit Protection
- Output Disable Function

KA278RA05C

- Nominal 5 V Output without Adjusting
- Output Adjustable between 1.27 V and 32 V
- 2 A Output Low-Dropout Voltage Regulator
- TO-220 Full-Mold Package (4 Pin)
- Over-Current Protection, Thermal Shutdown
- Over-Voltage Protection, Short-Circuit Protection

Description

The KA278RXXC is a low-dropout voltage regulator suitable for various electronic equipment. It provides a constant voltage power source in a TO-220 4-lead full-mold package. The dropout voltage is below 0.5 V in full-rated current (2 A). This regulator has peak current protection, thermal shutdown, and over-voltage protection.

TO-220F 4L



1. V_{IN} 2. V_O 3. GND 4. V_{dis} - KA278RXXC (33 / 05 / 12)
1. V_{IN} 2. V_O 3. GND 4. V_{adj} - KA278RA05C

Ordering Information

Part Number	Operating Temperature Range	Top Mark	Package	Packing Method
KA278R33CTU	-20 to 80°C	278R33	TO-220F 4L	Rail
KA278R05CTU		278R05		
KA278R12CTU		278R12		
KA278RA05CTU		278RA05		
KA278R12CYDTU		278R12	TO-220F 4L (Forming)	

Block Diagram

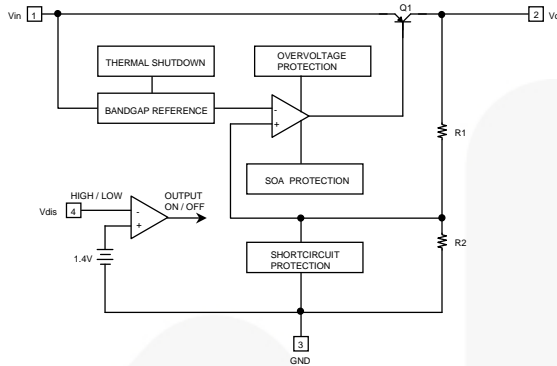

Figure 1. KA278R33 / 05 / 12C

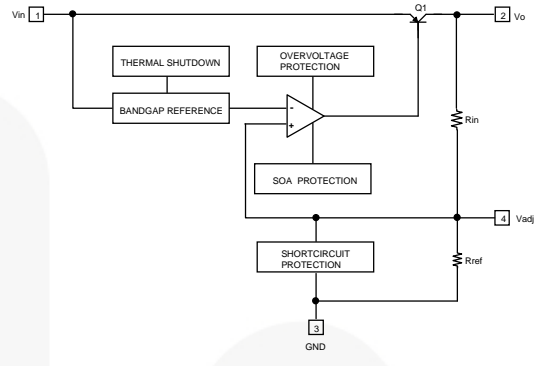

Figure 2. KA278RA05C

Absolute Maximum Ratings

Stresses exceeding the absolute maximum ratings may damage the device. The device may not function or be operable above the recommended operating conditions and stressing the parts to these levels is not recommended. In addition, extended exposure to stresses above the recommended operating conditions may affect device reliability. The absolute maximum ratings are stress ratings only. Values are at $T_A = 25^\circ\text{C}$ unless otherwise noted.

Symbol	Parameter		Value	Unit
V_{IN}	Input Voltage		35	V
V_{dis}	Disable Voltage	KA278RXXC	35	V
I_O	Output Current		2.0	A
P_{D1}	Power Dissipation 1	No Heat-Sink	1.5	W
P_{D2}	Power Dissipation 2	With Heat-Sink	15	W
T_j	Junction Temperature		150	$^\circ\text{C}$
T_{opr}	Operating Temperature		-20 to 80	$^\circ\text{C}$
$R_{\theta jc}$	Thermal Resistance, Junction-to Case ⁽¹⁾		2.9	$^\circ\text{C/W}$
$R_{\theta ja}$	Thermal Resistance, Junction-to-Air		48.51	$^\circ\text{C/W}$

Note:

- Junction-to-case thermal resistance test environments:
 - Pneumatic heat sink fixture;
 - Clamping pressure 60 psi through 12 mm diameter cylinder;
 - Thermal grease applied between PKG and heat sink fixture.

Electrical Characteristics

V_{IN} = Note 3, $I_O = 1.0$ A, $T_A = 25^\circ\text{C}$, unless otherwise specified.

Symbol	Parameter		Test Conditions	Min.	Typ.	Max.	Unit
V_O	Output Voltage	KA278R33C		3.22	3.30	3.38	V
		KA278R05C		4.88	5.00	5.12	
		KA278R12C		11.70	12.00	12.30	
R_{load}	Load Regulation		$5\text{ mA} < I_O < 2\text{ A}$		0.1	2.0	%
R_{line}	Line Regulation ⁽⁴⁾				0.5	2.5	%
RR	Ripple Rejection Ratio ⁽²⁾			45	55		dB
V_{drop}	Dropout Voltage		$I_O = 2\text{ A}$			0.5	V
V_{disH}	Disable Voltage High	KA278RXXC	Output Active	2.0			V
V_{disL}	Disable Voltage Low	KA278RXXC	Output Disabled			0.8	V
I_{disH}	Disable Bias Current High	KA278RXXC	$V_{dis} = 2.7\text{ V}$			20	μA
I_{disL}	Disable Bias Current Low	KA278RXXC	$V_{dis} = 0.4\text{ V}$			-0.4	mA
I_q	Quiescent Current		$I_O = 0\text{ A}$			10	mA
V_{ref}	Reference Voltage	KA278RA05C		1.24	1.27	1.30	V

Notes:

- These parameters, although guaranteed, are not 100% tested in production.
- KA278R33C: $V_{IN} = 5\text{ V}$;
KA278R05C: $V_{IN} = 7\text{ V}$;
KA278R12C: $V_{IN} = 15\text{ V}$.
- KA278R33C: $V_{IN} = 4\text{ V}$ to 10 V ;
KA278R05C: $V_{IN} = 6\text{ V}$ to 12 V ;
KA278R12C: $V_{IN} = 13\text{ V}$ to 29 V .

Typical Performance Characteristics (KA278R33C)

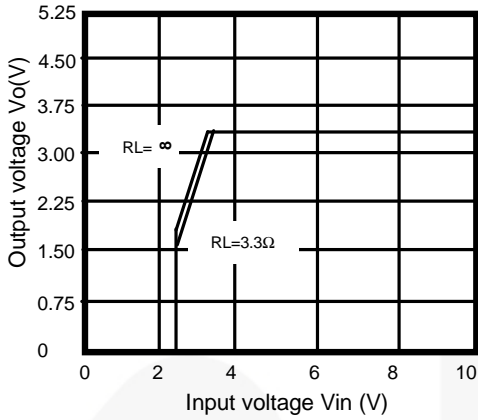

Figure 3. Output Voltage vs. Input Voltage

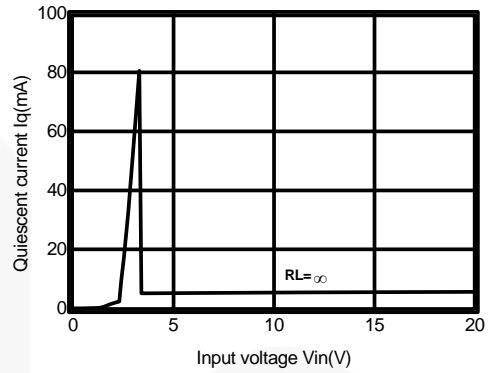

Figure 4. Quiescent Current vs. Input Voltage

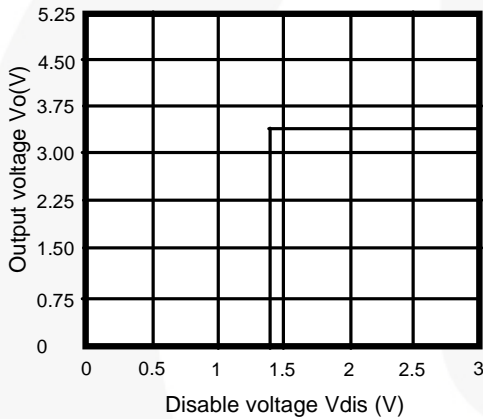

Figure 5. Output Voltage vs. Disable Voltage

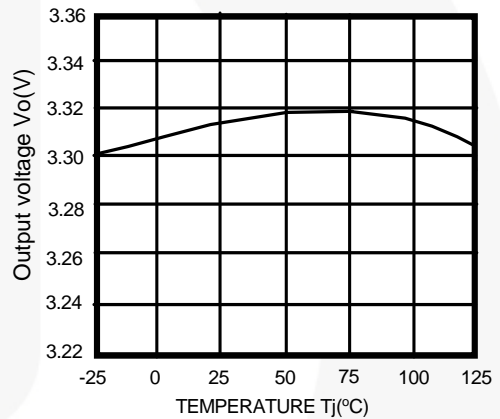

Figure 6. Output Voltage vs. Temperature (T_j)

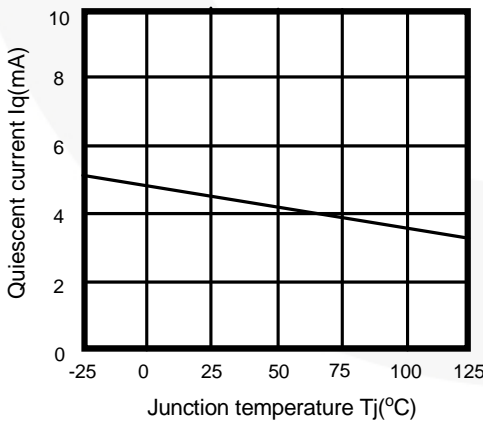

Figure 7. Quiescent Current vs. Temperature (T_j)

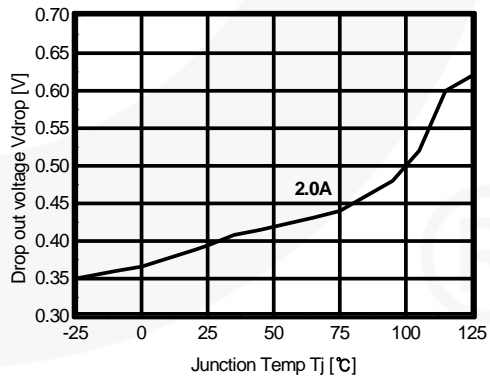

Figure 8. Dropout Voltage vs. Junction Temperature

Typical Performance Characteristics (Continued)

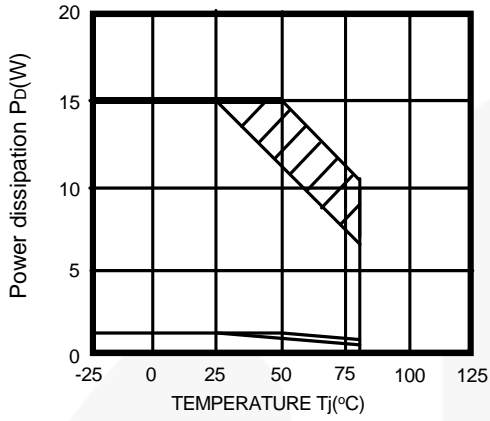

Figure 9. Power Dissipation vs. Temperature (T_j)

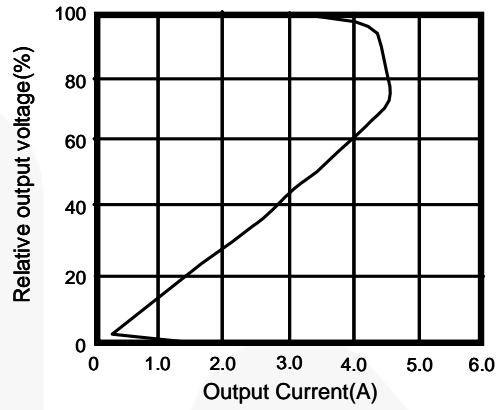

Figure 10. Over-Current Protection Characteristics (Typical Value)

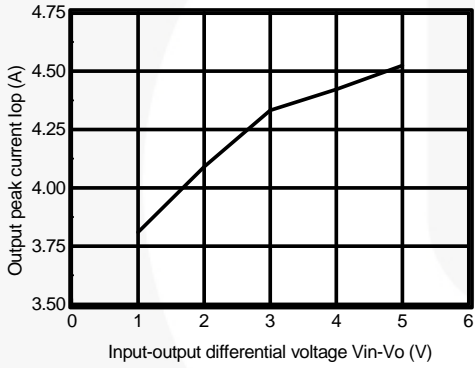

Figure 11. Output Peak Current vs. Input-Output Differential Voltage

Typical Performance Characteristics (KA278R05C)

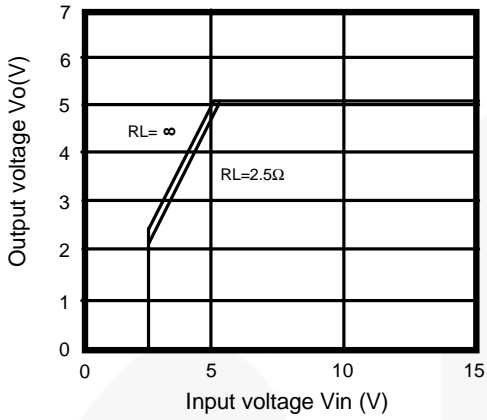

Figure 12. Output Voltage vs. Input Voltage

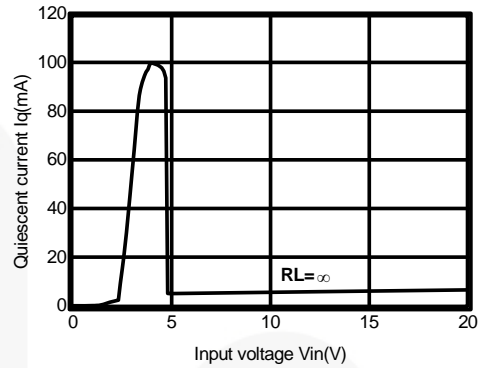

Figure 13. Quiescent Current vs. Input Voltage

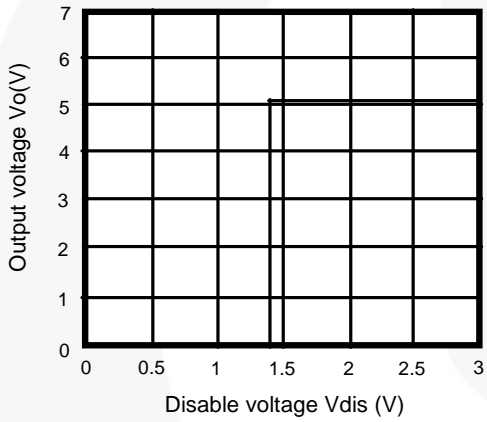

Figure 14. Output Voltage vs. Disable Voltage

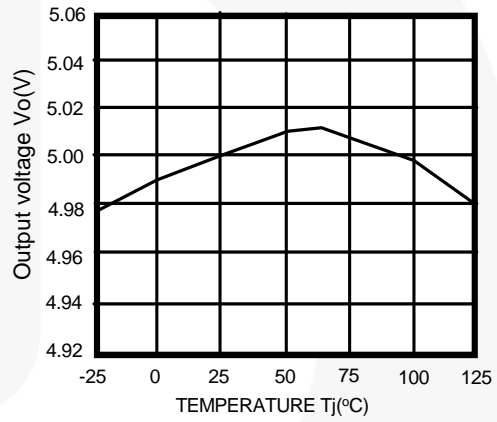

Figure 15. Output Voltage vs. Temperature (T_j)

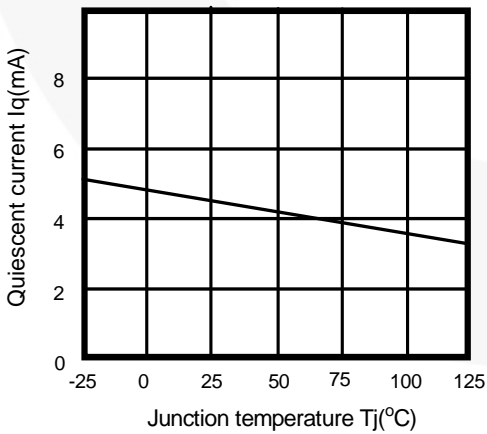

figure 16. Quiescent Current vs. Temperature (T_j)

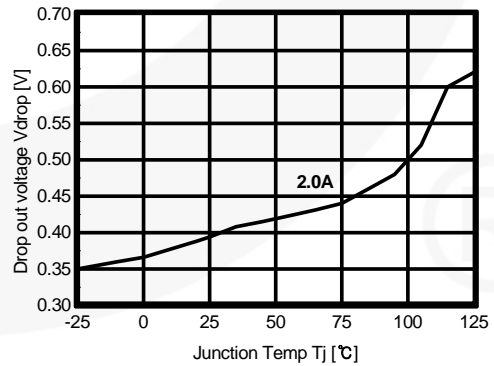

Figure 17. Dropout Voltage vs. Junction Temperature

Typical Performance Characteristics (Continued)

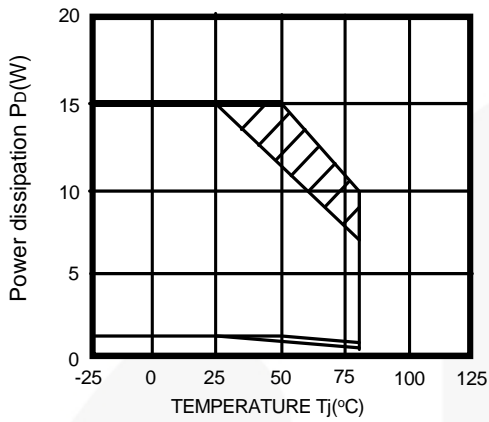

Figure 18. Power Dissipation vs. Temperature (T_j)

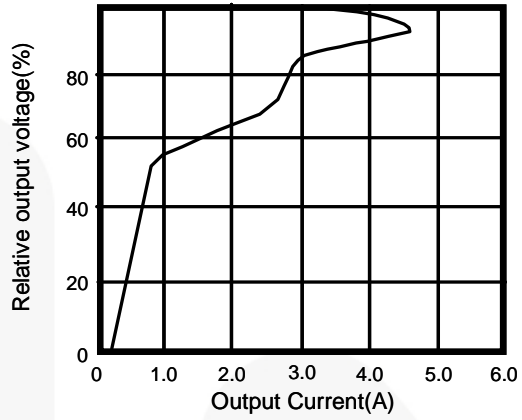

Figure 19. Over-Current Protection Characteristics (Typical Value)

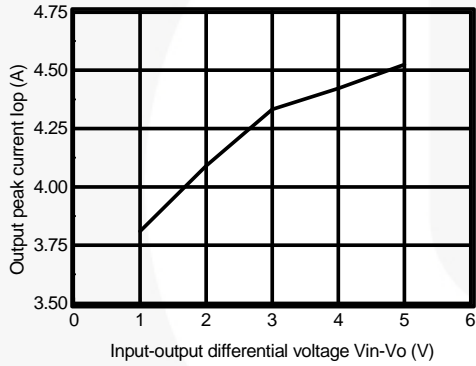

Figure 20. Output Peak Current vs. Input-Output Differential Voltage

Typical Performance Characteristics (KA278R12C)

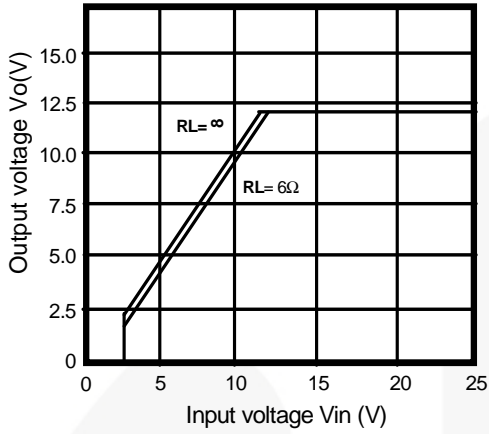

Figure 21. Output Voltage vs. Input Voltage

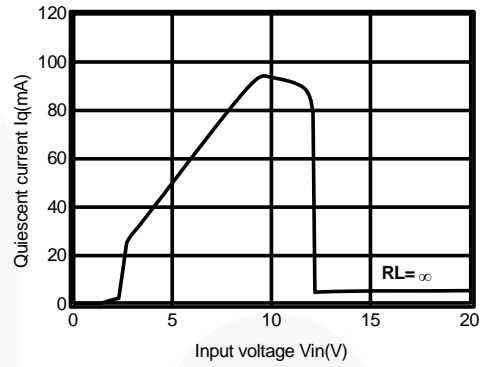

Figure 22. Quiescent Current vs. Input Voltage

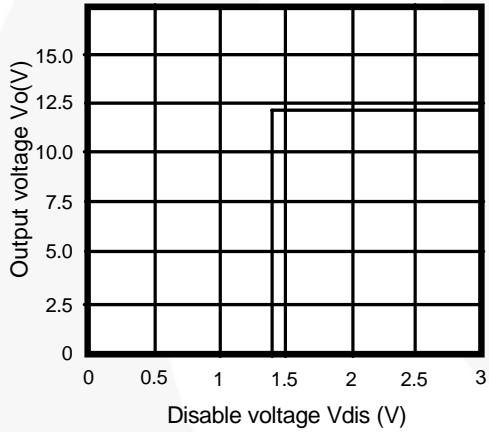

Figure 23. Output Voltage vs. Disable Voltage

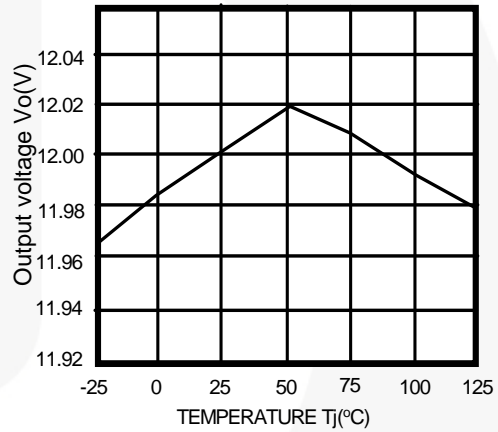
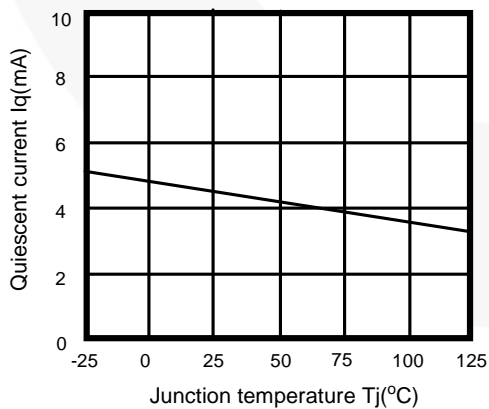

Figure 24. Output Voltage vs. Temperature (T_j)



25. Quiescent Current vs. Temperature (T_j)

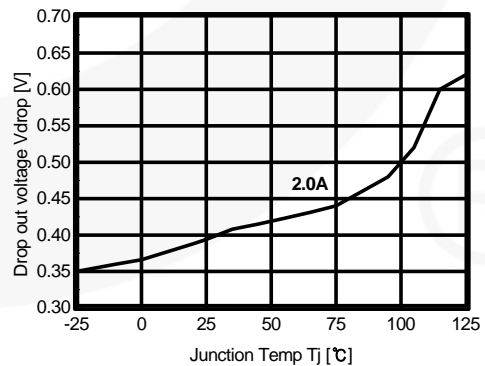

Figure 26. Dropout Voltage vs. Junction Temperature

Typical Performance Characteristics (Continued)

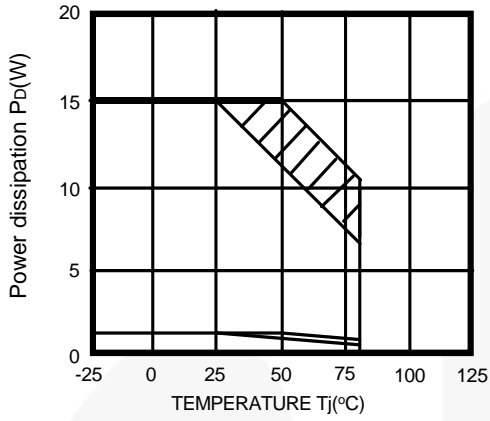

Figure 27. Power Dissipation vs. Temperature (T_j)

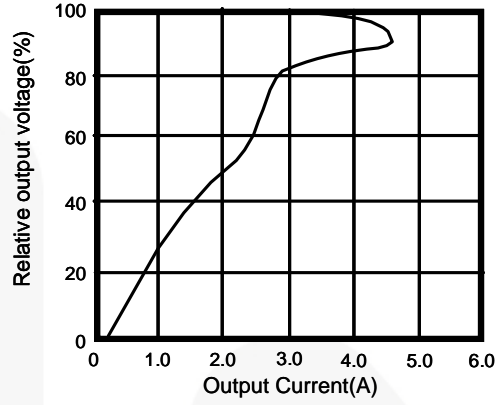

Figure 28. Over-Current Protection Characteristics (Typical Value)

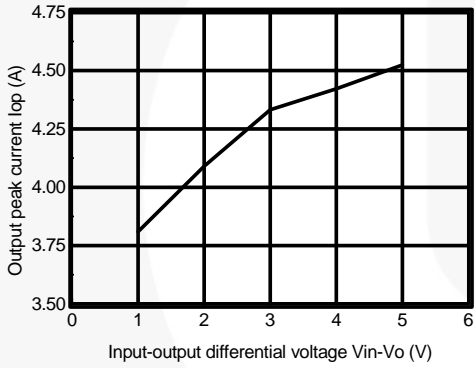

Figure 29. Output Peak Current vs. Input-Output Differential Voltage

Typical Performance Characteristics (KA278RA05C)

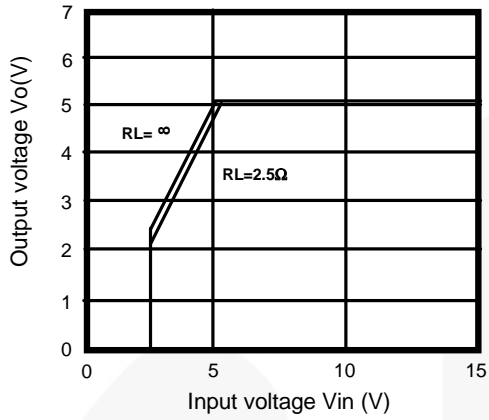

Figure 30. Output Voltage vs. Input Voltage

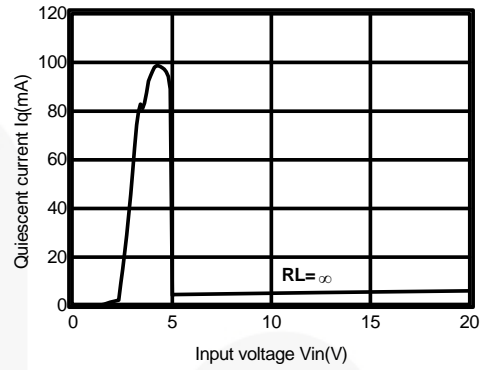

Figure 31. Quiescent Current vs. Input Voltage

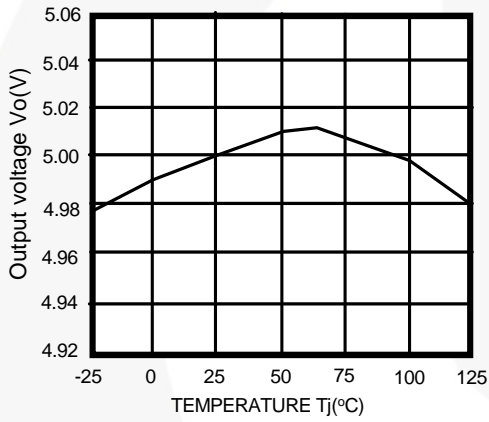

Figure 32. Output Voltage vs. Temperature (T_j)
*Fixed Mode (V_O = 5 V)

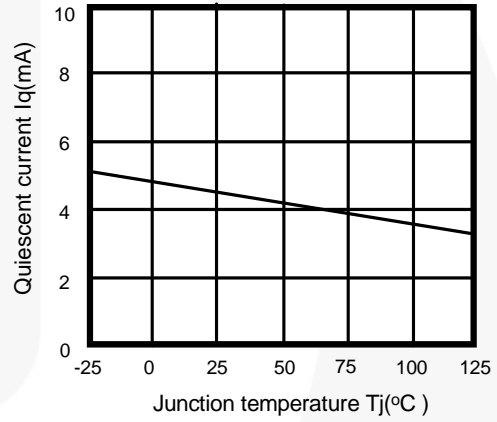

Figure 33. Quiescent Current vs. Temperature (T_j)

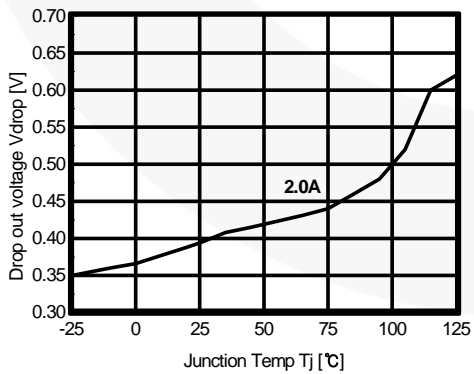

Figure 34. Dropout Voltage vs. Junction Temperature

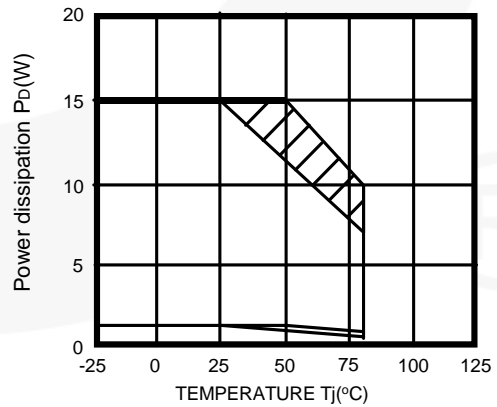

Figure 35. Power Dissipation vs. Temperature (T_j)

Typical Performance Characteristics (Continued)

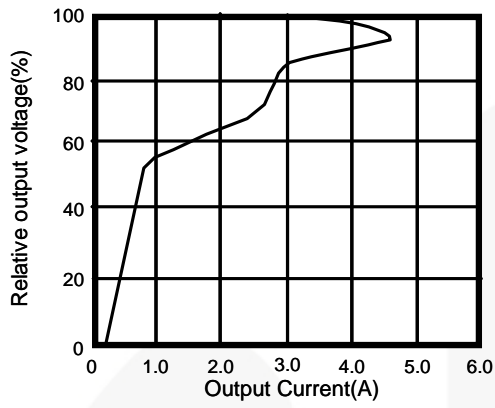

Figure 36. Over-Current Protection Characteristics (Typical Value)

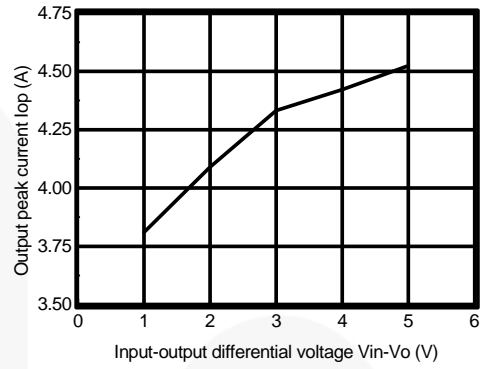

Figure 37. Output Peak Current vs. Input-Output Differential Voltage

Typical Application

KA278R33 / 05 / 12C

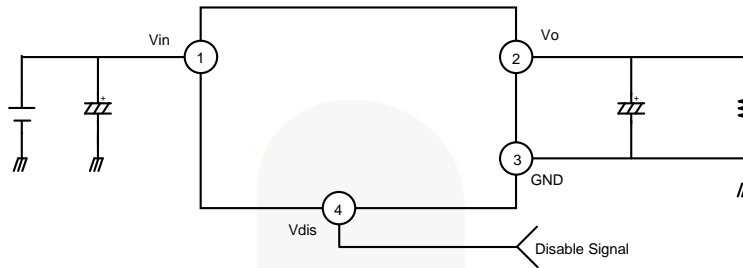
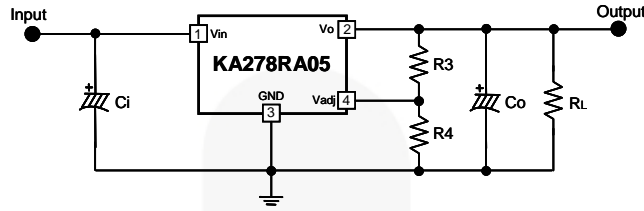

Figure 38. Application Circuit

- C_1 is required if regulator is located at an appreciable distance from power supply filter.
- C_O improves stability and transient response ($C_O > 47 \mu\text{F}$).

Typical Application (continued)

KA278RA05



$$V_o = 1.27 \left(1 + \frac{R_1/R_3}{R_2/R_4} \right) \quad R_1 = 1.8 \text{ k}\Omega, R_2 = 0.6 \text{ k}\Omega$$

Figure 39. Application Circuit (Adjustable Mode)

- C_i is required if regulator is located at an appreciable distance from power supply filter.
- C_o improves stability and transient response ($C_o > 47 \mu\text{F}$).

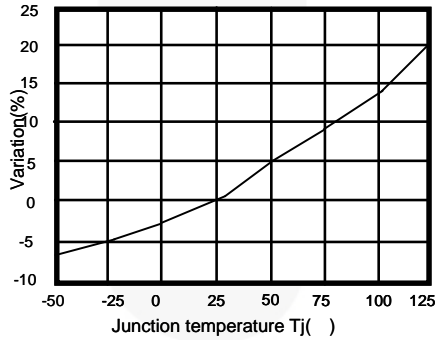

Figure 40. Internal Resistor (R_1, R_2) Variation vs. Temperature (T_j)

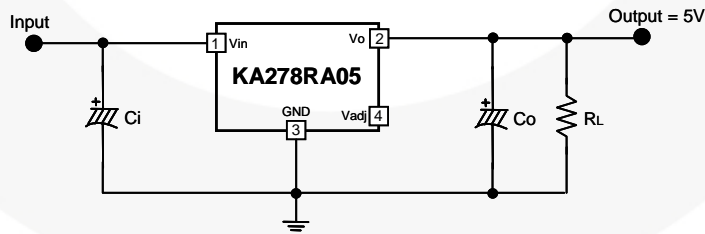

Figure 41. Application Circuit (Fixed Mode)

Physical Dimensions

TO-220F 4L

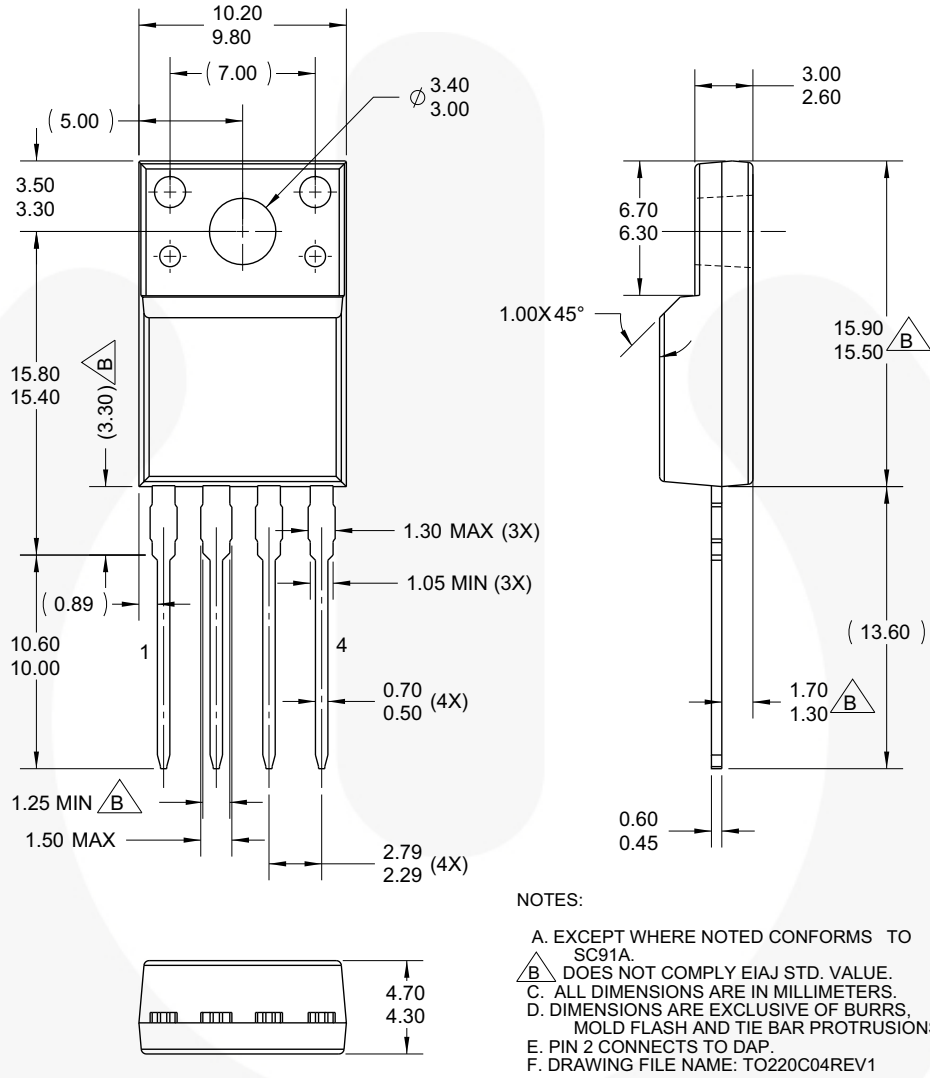

Figure 42. TO220, MOLDED, 4-LEAD, FULL-PACK, STARIGHT LEAD (ACTIVE)

Package drawings are provided as a service to customers considering Fairchild components. Drawings may change in any manner without notice. Please note the revision and/or date on the drawing and contact a Fairchild Semiconductor representative to verify or obtain the most recent revision. Package specifications do not expand the terms of Fairchild's worldwide terms and conditions, specifically the warranty therein, which covers Fairchild products.

Always visit Fairchild Semiconductor's online packaging area for the most recent package drawings:

<http://www.fairchildsemi.com/dwg/TO/TO220C04.pdf>

For current tape and reel specifications, visit Fairchild Semiconductor's online packaging area:

http://www.fairchildsemi.com/packaging_dwg/PKG-TO220C04.pdf

Physical Dimensions (continued)

TO-220F 4L (Forming)

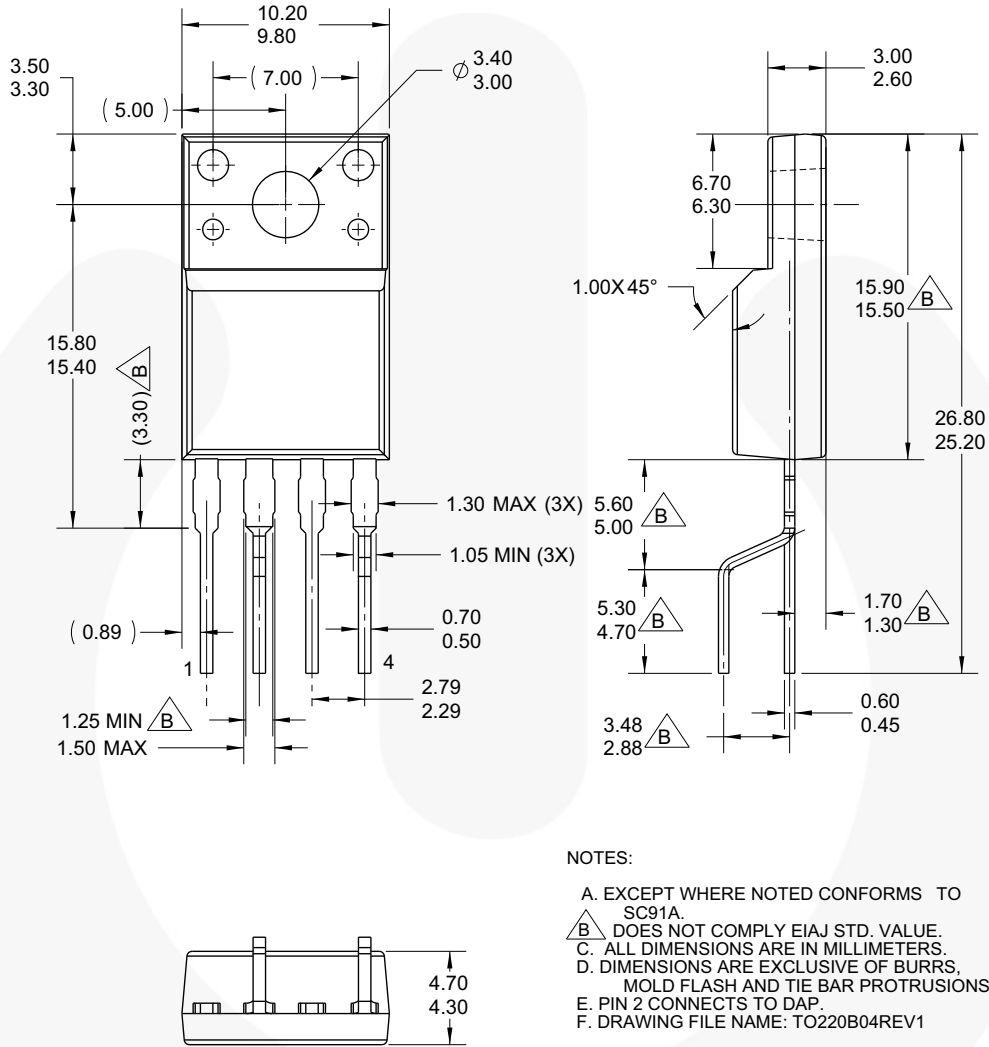

Figure 43. TO220, MOLDED, 4-LEAD, FULL-PACK, YDTU FORMING (ACTIVE)

Package drawings are provided as a service to customers considering Fairchild components. Drawings may change in any manner without notice. Please note the revision and/or date on the drawing and contact a Fairchild Semiconductor representative to verify or obtain the most recent revision. Package specifications do not expand the terms of Fairchild's worldwide terms and conditions, specifically the warranty therein, which covers Fairchild products.

Always visit Fairchild Semiconductor's online packaging area for the most recent package drawings:

<http://www.fairchildsemi.com/dwg/TO/TO220B04.pdf>





For current tape and reel specifications, visit Fairchild Semiconductor's online packaging area:

http://www.fairchildsemi.com/packing_dwg/PKG-TO220B04.pdf



TRADEMARKS

The following includes registered and unregistered trademarks and service marks, owned by Fairchild Semiconductor and/or its global subsidiaries, and is not intended to be an exhaustive list of all such trademarks.

2Cool™	FPS™		Sync-Lock™
AccuPower™	F-PFS™	PowerTrench®	
AX-CAP®*	FRFET®	PowerXS™	TinyBoost™
BitSiC™	Global Power Resource SM	Programmable Active Droop™	TinyBuck™
Build it Now™	GreenBridge™	QFET®	TinyCalc™
CorePLUS™	Green FPS™	QS™	TinyLogic®
CorePOWER™	Green FPS™ e-Series™	Quiet Series™	TINYOPTO™
CROSSVOLT™	Gmax™	RapidConfigure™	TinyPower™
CTL™	GTO™		TinyPWM™
Current Transfer Logic™	IntelliMAX™	Saving our world, 1mW/W/kW at a time™	TinyWire™
DEUXPEED®	ISOPLANAR™	SignalWise™	TranSiC™
Dual Cool™	Making Small Speakers Sound Louder and Better™	SmartMax™	TriFault Detect™
EcoSPARK®	MegaBuck™	SMART START™	TRUECURRENT®*
EfficientMax™	MICROCOUPLER™	Solutions for Your Success™	μSerDes™
ESBC™	MicroFET™	SPM®	
	MicroPak™	STEALTH™	UHC®
Fairchild®	MicroPak2™	SuperFET®	Ultra FRFET™
Fairchild Semiconductor®	MillerDrive™	SuperSOT™-3	UniFET™
FACT Quiet Series™	MotionMax™	SuperSOT™-6	VXC™
FACT®	mWSaver™	SuperSOT™-8	VisualMax™
FAST®	OptoHi™	SupreMOS®	VoltagePlus™
FastvCore™	OPTOLOGIC®	SyncFET™	XS™
FETBench™	OPTOPLANAR®		

* Trademarks of System General Corporation, used under license by Fairchild Semiconductor.

DISCLAIMER

FAIRCHILD SEMICONDUCTOR RESERVES THE RIGHT TO MAKE CHANGES WITHOUT FURTHER NOTICE TO ANY PRODUCTS HEREIN TO IMPROVE RELIABILITY, FUNCTION, OR DESIGN. FAIRCHILD DOES NOT ASSUME ANY LIABILITY ARISING OUT OF THE APPLICATION OR USE OF ANY PRODUCT OR CIRCUIT DESCRIBED HEREIN; NEITHER DOES IT CONVEY ANY LICENSE UNDER ITS PATENT RIGHTS, NOR THE RIGHTS OF OTHERS. THESE SPECIFICATIONS DO NOT EXPAND THE TERMS OF FAIRCHILD'S WORLDWIDE TERMS AND CONDITIONS, SPECIFICALLY THE WARRANTY THEREIN, WHICH COVERS THESE PRODUCTS.

LIFE SUPPORT POLICY

FAIRCHILD'S PRODUCTS ARE NOT AUTHORIZED FOR USE AS CRITICAL COMPONENTS IN LIFE SUPPORT DEVICES OR SYSTEMS WITHOUT THE EXPRESS WRITTEN APPROVAL OF FAIRCHILD SEMICONDUCTOR CORPORATION.

As used herein:

1. Life support devices or systems are devices or systems which, (a) are intended for surgical implant into the body or (b) support or sustain life, and (c) whose failure to perform when properly used in accordance with instructions for use provided in the labeling, can be reasonably expected to result in a significant injury of the user.
2. A critical component in any component of a life support, device, or system whose failure to perform can be reasonably expected to cause the failure of the life support device or system, or to affect its safety or effectiveness.

ANTI-COUNTERFEITING POLICY

Fairchild Semiconductor Corporation's Anti-Counterfeiting Policy. Fairchild's Anti-Counterfeiting Policy is also stated on our external website, www.fairchildsemi.com, under Sales Support.

Counterfeiting of semiconductor parts is a growing problem in the industry. All manufacturers of semiconductor products are experiencing counterfeiting of their parts. Customers who inadvertently purchase counterfeit parts experience many problems such as loss of brand reputation, substandard performance, failed applications, and increased cost of production and manufacturing delays. Fairchild is taking strong measures to protect ourselves and our customers from the proliferation of counterfeit parts. Fairchild strongly encourages customers to purchase Fairchild parts either directly from Fairchild or from Authorized Fairchild Distributors who are listed by country on our web page cited above. Products customers buy either from Fairchild directly or from Authorized Fairchild Distributors are genuine parts, have full traceability, meet Fairchild's quality standards for handling and storage and provide access to Fairchild's full range of up-to-date technical and product information. Fairchild and our Authorized Distributors will stand behind all warranties and will appropriately address any warranty issues that may arise. Fairchild will not provide any warranty coverage or other assistance for parts bought from Unauthorized Sources. Fairchild is committed to combat this global problem and encourage our customers to do their part in stopping this practice by buying direct or from authorized distributors.

PRODUCT STATUS DEFINITIONS

Definition of Terms

Datasheet Identification	Product Status	Definition
Advance Information	Formative / In Design	Datasheet contains the design specifications for product development. Specifications may change in any manner without notice.
Preliminary	First Production	Datasheet contains preliminary data; supplementary data will be published at a later date. Fairchild Semiconductor reserves the right to make changes at any time without notice to improve design.
No Identification Needed	Full Production	Datasheet contains final specifications. Fairchild Semiconductor reserves the right to make changes at any time without notice to improve the design.
Obsolete	Not In Production	Datasheet contains specifications on a product that is discontinued by Fairchild Semiconductor. The datasheet is for reference information only.

ON Semiconductor and  are trademarks of Semiconductor Components Industries, LLC dba ON Semiconductor or its subsidiaries in the United States and/or other countries. ON Semiconductor owns the rights to a number of patents, trademarks, copyrights, trade secrets, and other intellectual property. A listing of ON Semiconductor's product/patent coverage may be accessed at www.onsemi.com/site/pdf/Patent-Marking.pdf. ON Semiconductor reserves the right to make changes without further notice to any products herein. ON Semiconductor makes no warranty, representation or guarantee regarding the suitability of its products for any particular purpose, nor does ON Semiconductor assume any liability arising out of the application or use of any product or circuit, and specifically disclaims any and all liability, including without limitation special, consequential or incidental damages. Buyer is responsible for its products and applications using ON Semiconductor products, including compliance with all laws, regulations and safety requirements or standards, regardless of any support or applications information provided by ON Semiconductor. "Typical" parameters which may be provided in ON Semiconductor data sheets and/or specifications can and do vary in different applications and actual performance may vary over time. All operating parameters, including "Typicals" must be validated for each customer application by customer's technical experts. ON Semiconductor does not convey any license under its patent rights nor the rights of others. ON Semiconductor products are not designed, intended, or authorized for use as a critical component in life support systems or any FDA Class 3 medical devices or medical devices with a same or similar classification in a foreign jurisdiction or any devices intended for implantation in the human body. Should Buyer purchase or use ON Semiconductor products for any such unintended or unauthorized application, Buyer shall indemnify and hold ON Semiconductor and its officers, employees, subsidiaries, affiliates, and distributors harmless against all claims, costs, damages, and expenses, and reasonable attorney fees arising out of, directly or indirectly, any claim of personal injury or death associated with such unintended or unauthorized use, even if such claim alleges that ON Semiconductor was negligent regarding the design or manufacture of the part. ON Semiconductor is an Equal Opportunity/Affirmative Action Employer. This literature is subject to all applicable copyright laws and is not for resale in any manner.

PUBLICATION ORDERING INFORMATION

LITERATURE FULFILLMENT:

Literature Distribution Center for ON Semiconductor
19521 E. 32nd Pkwy, Aurora, Colorado 80011 USA
Phone: 303-675-2175 or 800-344-3860 Toll Free USA/Canada
Fax: 303-675-2176 or 800-344-3867 Toll Free USA/Canada
Email: orderlit@onsemi.com

N. American Technical Support: 800-282-9855 Toll Free
USA/Canada
Europe, Middle East and Africa Technical Support:
Phone: 421 33 790 2910
Japan Customer Focus Center
Phone: 81-3-5817-1050

ON Semiconductor Website: www.onsemi.com
Order Literature: <http://www.onsemi.com/orderlit>
For additional information, please contact your local
Sales Representative