



Is Now Part of



ON Semiconductor®

To learn more about ON Semiconductor, please visit our website at
www.onsemi.com

ON Semiconductor and the ON Semiconductor logo are trademarks of Semiconductor Components Industries, LLC dba ON Semiconductor or its subsidiaries in the United States and/or other countries. ON Semiconductor owns the rights to a number of patents, trademarks, copyrights, trade secrets, and other intellectual property. A listing of ON Semiconductor's product/patent coverage may be accessed at www.onsemi.com/site/pdf/Patent-Marking.pdf. ON Semiconductor reserves the right to make changes without further notice to any products herein. ON Semiconductor makes no warranty, representation or guarantee regarding the suitability of its products for any particular purpose, nor does ON Semiconductor assume any liability arising out of the application or use of any product or circuit, and specifically disclaims any and all liability, including without limitation special, consequential or incidental damages. Buyer is responsible for its products and applications using ON Semiconductor products, including compliance with all laws, regulations and safety requirements or standards, regardless of any support or applications information provided by ON Semiconductor. "Typical" parameters which may be provided in ON Semiconductor data sheets and/or specifications can and do vary in different applications and actual performance may vary over time. All operating parameters, including "Typicals" must be validated for each customer application by customer's technical experts. ON Semiconductor does not convey any license under its patent rights nor the rights of others. ON Semiconductor products are not designed, intended, or authorized for use as a critical component in life support systems or any FDA Class 3 medical devices or medical devices with a same or similar classification in a foreign jurisdiction or any devices intended for implantation in the human body. Should Buyer purchase or use ON Semiconductor products for any such unintended or unauthorized application, Buyer shall indemnify and hold ON Semiconductor and its officers, employees, subsidiaries, affiliates, and distributors harmless against all claims, costs, damages, and expenses, and reasonable attorney fees arising out of, directly or indirectly, any claim of personal injury or death associated with such unintended or unauthorized use, even if such claim alleges that ON Semiconductor was negligent regarding the design or manufacture of the part. ON Semiconductor is an Equal Opportunity/Affirmative Action Employer. This literature is subject to all applicable copyright laws and is not for resale in any manner.

MM74HC574 3-STATE Octal D-Type Edge-Triggered Flip-Flop

General Description

The MM74HC574 high speed octal D-type flip-flops utilize advanced silicon-gate P-well CMOS technology. They possess the high noise immunity and low power consumption of standard CMOS integrated circuits, as well as the ability to drive 15 LS-TTL loads. Due to the large output drive capability and the 3-STATE feature, these devices are ideally suited for interfacing with bus lines in a bus organized system.

These devices are positive edge triggered flip-flops. Data at the D inputs, meeting the set-up and hold time requirements, are transferred to the Q outputs on positive going transitions of the CLOCK (CK) input. When a high logic level is applied to the OUTPUT CONTROL (OC) input, all outputs go to a high impedance state, regardless of what signals are present at the other inputs and the state of the storage elements.

The 74HC logic family is speed, function, and pinout compatible with the standard 74LS logic family. All inputs are protected from damage due to static discharge by internal diode clamps to V_{CC} and ground.

Features

- Typical propagation delay: 18 ns
- Wide operating voltage range: 2V–6V
- Low input current: 1 μ A maximum
- Low quiescent current: 80 μ A maximum
- Compatible with bus-oriented systems
- Output drive capability: 15 LS-TTL loads

Ordering Code:

Order Number	Package Number	Package Description
MM74HC574WM	M20B	20-Lead Small Outline Integrated Circuit (SOIC), JEDEC MS-013, 0.300" Wide
MM74HC574SJ	M20D	20-Lead Small Outline Package (SOP), EIAJ TYPE II, 5.3mm Wide
MM74HC574MTC	MTC20	20-Lead Thin Shrink Small Outline Package (TSSOP), JEDEC MO-153, 4.4mm Wide
MM74HC574N	N20A	20-Lead Plastic Dual-In-Line Package (PDIP), JEDEC MS-001, 0.300" Wide

Devices also available in Tape and Reel. Specify by appending the suffix letter "X" to the ordering code.

Connection Diagram

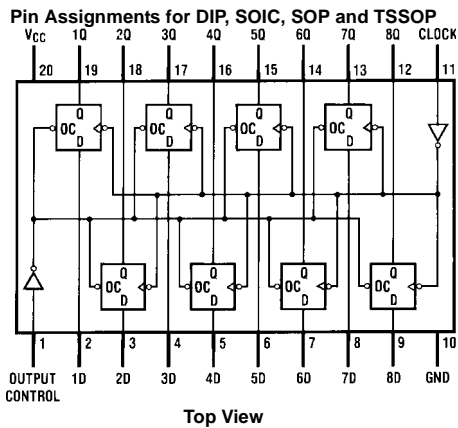

Truth Table

Output Control	Clock	Data	Output
L	↑	H	H
L	↑	L	L
L	L	X	Q_0
H	X	X	Z

H = HIGH Level
L = LOW Level
X = Don't Care
↑ = Transition from LOW-to-HIGH
Z = High Impedance State
 Q_0 = The level of the output before steady state input conditions were established

Absolute Maximum Ratings (Note 1)

(Note 2)

Supply Voltage (V_{CC})	-0.5 to +7.0V
DC Input Voltage (V_{IN})	-1.5 to $V_{CC} + 1.5V$
DC Output Voltage (V_{OUT})	-0.5 to $V_{CC} + 0.5V$
Clamp Diode Current (I_{IK}, I_{OK})	± 20 mA
DC Output Current, per pin (I_{OUT})	± 35 mA
DC V_{CC} or GND Current, per pin (I_{CC})	± 70 mA
Storage Temperature Range (T_{STG})	-65°C to +150°C
Power Dissipation (P_D)	
(Note 3)	600 mW
S.O. Package only	500 mW
Lead Temperature (T_L)	
(Soldering 10 seconds)	260°C

Recommended Operating Conditions

	Min	Max	Units
Supply Voltage (V_{CC})	2	6	V
DC Input or Output Voltage (V_{IN}, V_{OUT})	0	V_{CC}	V
Operating Temperature Range (T_A)	-40	+85	°C
Input Rise or Fall Times (t_r, t_f)			
$V_{CC} = 2.0V$		1000	ns
$V_{CC} = 4.5V$		500	ns
$V_{CC} = 6.0V$		400	ns

Note 1: Maximum Ratings are those values beyond which damage to the device may occur.

Note 2: Unless otherwise specified all voltages are referenced to ground.

Note 3: Power Dissipation temperature derating — plastic "N" package: -12 mW/°C from 65°C to 85°C.

DC Electrical Characteristics (Note 4)

Symbol	Parameter	Conditions	V_{CC}	$T_A = 25^\circ\text{C}$			Units	
				Typ	Guaranteed Limits			
V_{IH}	Minimum HIGH Level Input Voltage		2.0V		1.5	1.5	V	
			4.5V		3.15	3.15		
			6.0V		4.2	4.2		
V_{IL}	Maximum LOW Level Input Voltage		2.0V		0.5	0.5	V	
			4.5V		1.35	1.35		
			6.0V		1.8	1.8		
V_{OH}	Minimum HIGH Level Output Voltage	$V_{IN} = V_{IH}$ or V_{IL} $ I_{OUT} \leq 20 \mu\text{A}$	2.0V	2.0	1.9	1.9	V	
			4.5V	4.5	4.4	4.4		
			6.0V	6.0	5.9	5.9		
		$V_{IN} = V_{IH}$ or V_{IL} $ I_{OUT} \leq 6.0 \text{ mA}$ $ I_{OUT} \leq 7.8 \text{ mA}$	4.5V	4.2	3.98	3.84	V	
			6.0V	5.7	5.48	5.34		
			6.0V	5.7	5.48	5.34		
V_{OL}	Maximum LOW Level Output Voltage	$V_{IN} = V_{IH}$ or V_{IL} $ I_{OUT} \leq 20 \mu\text{A}$	2.0V	0	0.1	0.1	V	
			4.5V	0	0.1	0.1		
			6.0V	0	0.1	0.1		
		$V_{IN} = V_{IH}$ or V_{IL} $ I_{OUT} \leq 6.0 \text{ mA}$ $ I_{OUT} \leq 7.8 \text{ mA}$	4.5V	0.2	0.26	0.33	V	
			6.0V	0.2	0.26	0.33		
			6.0V	0.2	0.26	0.33		
I_{IN}	Maximum Input Current	$V_{IN} = V_{CC}$ or GND	6.0V		± 0.1	± 1.0	± 1.0	μA
I_{OZ}	Maximum 3-STATE Output Leakage Current	$V_{OUT} = V_{CC}$ or GND $OC = V_{IH}$	6.0V		± 0.5	± 5.0	± 10	μA
I_{CC}	Maximum Quiescent Supply Current	$V_{IN} = V_{CC}$ or GND $I_{OUT} = 0 \mu\text{A}$	6.0V		8.0	80	160	μA
ΔI_{CC}	Quiescent Supply Current per Input Pin	$V_{CC} = 5.5V$ $V_{IN} = 2.4V$ or 0.4V (Note 4)	OE	1.0	1.5	1.8	2.0	mA
			CLK	0.6	0.8	1.0	1.1	
			DATA	0.4	0.5	0.6	0.7	

Note 4: For a power supply of 5V $\pm 10\%$ the worst-case output voltages (V_{OH} and V_{OL}) occur for HC at 4.5V. Thus the 4.5V values should be used when designing with this supply. Worst-case V_{IH} and V_{IL} occur at $V_{CC} = 5.5V$ and 4.5V respectively. (The V_{IH} value at 5.5V is 3.85V.) The worst-case leakage current (I_{IN} , I_{CC} , and I_{OZ}) occur for CMOS at the higher voltage and so the 6.0V values should be used.

AC Electrical Characteristics								
$V_{CC} = 5V, T_A = 25^\circ C, t_r = t_f = 6 ns$								
Symbol	Parameter	Conditions	Typ	Guaranteed Limit	Units			
f_{MAX}	Maximum Operating Frequency		60	33	MHz			
t_{PHL}, t_{PLH}	Maximum Propagation Delay, Clock to Q	$C_L = 45 pF$	17	27	ns			
t_{PZH}, t_{PZL}	Maximum Output Enable Time	$R_L = 1 k\Omega$ $C_L = 45 pF$	19	28	ns			
t_{PHZ}, t_{PLZ}	Maximum Output Disable Time	$R_L = 1 k\Omega$ $C_L = 5 pF$	14	25	ns			
t_S	Minimum Setup Time, Data to Clock		10	12	ns			
t_H	Minimum Hold Time, Clock to Data		-3	5	ns			
t_W	Minimum Pulse Clock Width		8	15	ns			
AC Electrical Characteristics								
$V_{CC} = 2.0 - 6.0V, C_L = 50 pF, t_r = t_f = 6 ns$ (unless otherwise specified)								
Symbol	Parameter	Conditions	V_{CC}	$T_A = 25^\circ C$	$T_A = -40 to 85^\circ C$	$T_A = -55 to 125^\circ C$	Units	
				Typ	Guaranteed Limits			
f_{MAX}	Maximum Operating Frequency	$C_L = 50 pF$	2.0V 4.5V 6.0V		33 30 35	28 24 28	23 20 23	MHz
t_{PHL}, t_{PLH}	Maximum Propagation Delay, Clock to Q	$C_L = 50 pF$	2.0V	18	30	38	45	ns
		$C_L = 150 pF$	2.0V	51	155	194	233	ns
		$C_L = 50 pF$	4.5V	13	23	29	35	ns
		$C_L = 150 pF$	4.5V	19	31	47	47	ns
		$C_L = 50 pF$	6.0V	12	20	25	30	ns
		$C_L = 150 pF$	6.0V	18	27	34	41	ns
t_{PZH}, t_{PZL}	Maximum Output Enable Time	$R_L = 1 k\Omega$	2.0V	22	30	38	45	ns
		$C_L = 50 pF$	2.0V	59	180	225	270	ns
		$C_L = 150 pF$	2.0V	59	180	225	270	ns
		$C_L = 50 pF$	4.5V	14	28	35	42	ns
		$C_L = 150 pF$	4.5V	20	36	45	54	ns
		$C_L = 50 pF$	6.0V	12	24	30	36	ns
t_{PHZ}, t_{PLZ}	Maximum Output Disable Time	$R_L = 1 k\Omega$	2.0V	15	30	38	45	ns
		$C_L = 50 pF$	4.5V	12	25	31	38	ns
		$C_L = 50 pF$	6.0V	10	21	27	32	ns
t_S	Minimum Setup Time Data to Clock		2.0V	6	12	15	18	ns
			4.5V		20	25	30	ns
			6.0V		17	21	25	ns
t_H	Minimum Hold Time Clock to Data		2.0V	-1	5	6	8	ns
			4.5V		0	0	0	ns
			6.0V		0	0	0	ns
t_{THL}, t_{TLH}	Maximum Output Rise and Fall Time	$C_L = 50 pF$	2.0V	6	12	15	18	ns
			4.5V	7	12	15	18	ns
			6.0V	6	10	13	15	ns
t_W	Minimum Clock Pulse Width		2.0V	30	15	20	24	ns
			4.5V	9	16	20	24	ns
			6.0V	8	14	18	20	ns
t_r, t_f	Maximum Clock Input Rise and Fall Time		2.0V		1000	1000	1000	ns
			4.5V		500	500	500	ns
			6.0V		400	400	400	ns
C_{PD}	Power Dissipation Capacitance (Note 5) (per latch)	$OC = V_{CC}$		5				pF
		$OC = GND$		58				pF
C_{IN}	Maximum Input Capacitance			5	10	10	10	pF

AC Electrical Characteristics (Continued)

Symbol	Parameter	Conditions	V _{CC}	T _A = 25°C		T _A = -40 to 85°C	T _A = -55 to 125°C	Units
				Typ	Guaranteed Limits			
C _{OUT}	Maximum Output Capacitance			15	20	20	20	pF

Note 5: C_{PD} determines the no load dynamic power consumption, $P_D = C_{PD} V_{CC}^2 f + I_{CC} V_{CC}$, and the no load dynamic current consumption, $I_S = C_{PD} V_{CC} f + I_{CC}$.

Physical Dimensions inches (millimeters) unless otherwise noted



**20-Lead Small Outline Integrated Circuit (SOIC), JEDEC MS-013, 0.300" Wide
Package Number M20B**

Physical Dimensions inches (millimeters) unless otherwise noted (Continued)

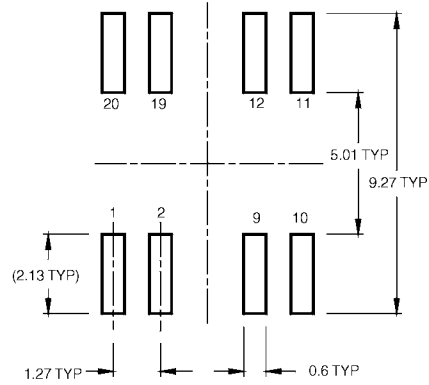
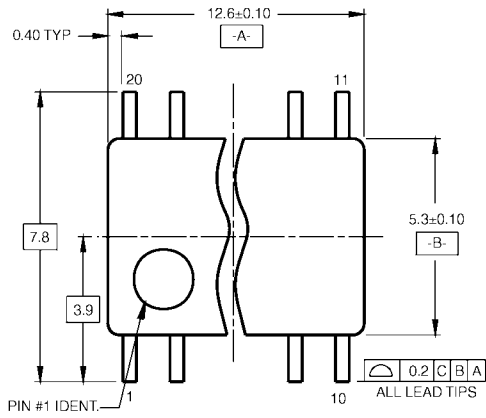

LAND PATTERN RECOMMENDATION

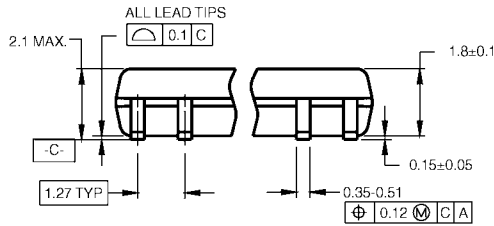

DIMENSIONS ARE IN MILLIMETERS

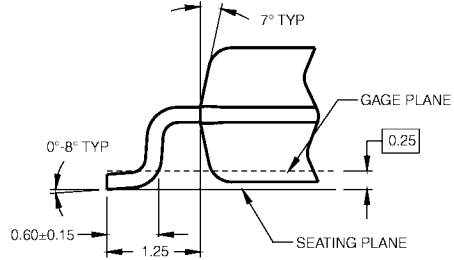
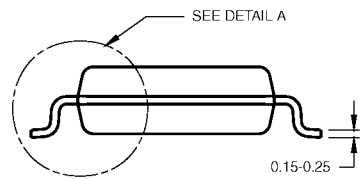

DETAIL A

- NOTES:
- A. CONFORMS TO EIAJ EDR-7320 REGISTRATION, ESTABLISHED IN DECEMBER, 1998.
 - B. DIMENSIONS ARE IN MILLIMETERS.
 - C. DIMENSIONS ARE EXCLUSIVE OF BURRS, MOLD FLASH, AND TIE BAR EXTRUSIONS.

M20DRevB1

**20-Lead Small Outline Package (SOP), EIAJ TYPE II, 5.3mm Wide
Package Number M20D**

Physical Dimensions inches (millimeters) unless otherwise noted (Continued)

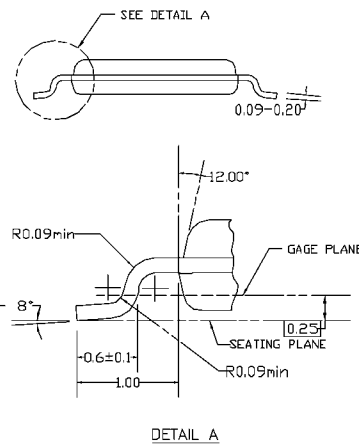

DIMENSIONS ARE IN MILLIMETERS

- NOTES:
- A. CONFORMS TO JEDEC REGISTRATION MO-153, VARIATION AC, REF NOTE 6, DATE 7/93.
 - B. DIMENSIONS ARE IN MILLIMETERS.
 - C. DIMENSIONS ARE EXCLUSIVE OF BURRS, MOLDS FLASH, AND TIE BAR EXTRUSIONS.
 - D. DIMENSIONS AND TOLERANCES PER ANSI Y14.5M, 1982.

MTC20REVD1

20-Lead Thin Shrink Small Outline Package (TSSOP), JEDEC MO-153, 4.4mm Wide Package Number MTC20

Physical Dimensions inches (millimeters) unless otherwise noted (Continued)



**20-Lead Plastic Dual-In-Line Package (PDIP), JEDEC MS-001, 0.300" Wide
Package Number N20A**

N20A (REV G)

Fairchild does not assume any responsibility for use of any circuitry described, no circuit patent licenses are implied and Fairchild reserves the right at any time without notice to change said circuitry and specifications.

LIFE SUPPORT POLICY

FAIRCHILD'S PRODUCTS ARE NOT AUTHORIZED FOR USE AS CRITICAL COMPONENTS IN LIFE SUPPORT DEVICES OR SYSTEMS WITHOUT THE EXPRESS WRITTEN APPROVAL OF THE PRESIDENT OF FAIRCHILD SEMICONDUCTOR CORPORATION. As used herein:

1. Life support devices or systems are devices or systems which, (a) are intended for surgical implant into the body, or (b) support or sustain life, and (c) whose failure to perform when properly used in accordance with instructions for use provided in the labeling, can be reasonably expected to result in a significant injury to the user.
2. A critical component in any component of a life support device or system whose failure to perform can be reasonably expected to cause the failure of the life support device or system, or to affect its safety or effectiveness.

www.fairchildsemi.com

ON Semiconductor and  are trademarks of Semiconductor Components Industries, LLC dba ON Semiconductor or its subsidiaries in the United States and/or other countries. ON Semiconductor owns the rights to a number of patents, trademarks, copyrights, trade secrets, and other intellectual property. A listing of ON Semiconductor's product/patent coverage may be accessed at www.onsemi.com/site/pdf/Patent-Marking.pdf. ON Semiconductor reserves the right to make changes without further notice to any products herein. ON Semiconductor makes no warranty, representation or guarantee regarding the suitability of its products for any particular purpose, nor does ON Semiconductor assume any liability arising out of the application or use of any product or circuit, and specifically disclaims any and all liability, including without limitation special, consequential or incidental damages. Buyer is responsible for its products and applications using ON Semiconductor products, including compliance with all laws, regulations and safety requirements or standards, regardless of any support or applications information provided by ON Semiconductor. "Typical" parameters which may be provided in ON Semiconductor data sheets and/or specifications can and do vary in different applications and actual performance may vary over time. All operating parameters, including "Typicals" must be validated for each customer application by customer's technical experts. ON Semiconductor does not convey any license under its patent rights nor the rights of others. ON Semiconductor products are not designed, intended, or authorized for use as a critical component in life support systems or any FDA Class 3 medical devices or medical devices with a same or similar classification in a foreign jurisdiction or any devices intended for implantation in the human body. Should Buyer purchase or use ON Semiconductor products for any such unintended or unauthorized application, Buyer shall indemnify and hold ON Semiconductor and its officers, employees, subsidiaries, affiliates, and distributors harmless against all claims, costs, damages, and expenses, and reasonable attorney fees arising out of, directly or indirectly, any claim of personal injury or death associated with such unintended or unauthorized use, even if such claim alleges that ON Semiconductor was negligent regarding the design or manufacture of the part. ON Semiconductor is an Equal Opportunity/Affirmative Action Employer. This literature is subject to all applicable copyright laws and is not for resale in any manner.

PUBLICATION ORDERING INFORMATION

LITERATURE FULFILLMENT:

Literature Distribution Center for ON Semiconductor
19521 E. 32nd Pkwy, Aurora, Colorado 80011 USA
Phone: 303-675-2175 or 800-344-3860 Toll Free USA/Canada
Fax: 303-675-2176 or 800-344-3867 Toll Free USA/Canada
Email: orderlit@onsemi.com

N. American Technical Support: 800-282-9855 Toll Free
USA/Canada
Europe, Middle East and Africa Technical Support:
Phone: 421 33 790 2910
Japan Customer Focus Center
Phone: 81-3-5817-1050

ON Semiconductor Website: www.onsemi.com
Order Literature: <http://www.onsemi.com/orderlit>
For additional information, please contact your local
Sales Representative