



Is Now Part of



ON Semiconductor®

To learn more about ON Semiconductor, please visit our website at
www.onsemi.com

ON Semiconductor and the ON Semiconductor logo are trademarks of Semiconductor Components Industries, LLC dba ON Semiconductor or its subsidiaries in the United States and/or other countries. ON Semiconductor owns the rights to a number of patents, trademarks, copyrights, trade secrets, and other intellectual property. A listing of ON Semiconductor's product/patent coverage may be accessed at www.onsemi.com/site/pdf/Patent-Marking.pdf. ON Semiconductor reserves the right to make changes without further notice to any products herein. ON Semiconductor makes no warranty, representation or guarantee regarding the suitability of its products for any particular purpose, nor does ON Semiconductor assume any liability arising out of the application or use of any product or circuit, and specifically disclaims any and all liability, including without limitation special, consequential or incidental damages. Buyer is responsible for its products and applications using ON Semiconductor products, including compliance with all laws, regulations and safety requirements or standards, regardless of any support or applications information provided by ON Semiconductor. "Typical" parameters which may be provided in ON Semiconductor data sheets and/or specifications can and do vary in different applications and actual performance may vary over time. All operating parameters, including "Typicals" must be validated for each customer application by customer's technical experts. ON Semiconductor does not convey any license under its patent rights nor the rights of others. ON Semiconductor products are not designed, intended, or authorized for use as a critical component in life support systems or any FDA Class 3 medical devices or medical devices with a same or similar classification in a foreign jurisdiction or any devices intended for implantation in the human body. Should Buyer purchase or use ON Semiconductor products for any such unintended or unauthorized application, Buyer shall indemnify and hold ON Semiconductor and its officers, employees, subsidiaries, affiliates, and distributors harmless against all claims, costs, damages, and expenses, and reasonable attorney fees arising out of, directly or indirectly, any claim of personal injury or death associated with such unintended or unauthorized use, even if such claim alleges that ON Semiconductor was negligent regarding the design or manufacture of the part. ON Semiconductor is an Equal Opportunity/Affirmative Action Employer. This literature is subject to all applicable copyright laws and is not for resale in any manner.



June 2015

HMHA281, HMHA2801 Series 4-Pin Half-Pitch Mini-Flat Phototransistor Optocouplers

Features

- Compact 4-pin Package
 - 2.4 mm Maximum Standoff Height
 - Half-pitch Leads for Optimum Board Space Savings
- Current Transfer Ratio:
 - HMHA281: 50% to 600%
 - HMHA2801: 80% to 600%
 - HMHA2801A: 80% to 160%
 - HMHA2801B: 130% to 260%
 - HMHA2801C: 200% to 400%
- Safety and Regulatory Approvals:
 - UL1577, 3,750 VAC_{RMS} for 1 Minute
 - DIN-EN/IEC60747-5-5, 565 V Peak Working Insulation Voltage

Applications

- Digital Logic Inputs
- Microprocessor Inputs
- Power Supply Monitor
- Twisted Pair Line Receiver
- Telephone Line Receiver

Description

The HMHA281 and HMHA2801 series devices consist of a gallium arsenide infrared emitting diode driving a silicon phototransistor in a compact 4-pin mini-flat package. The lead pitch is 1.27 mm.

Schematic

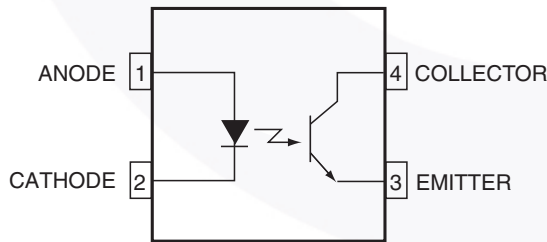

Figure 1. Schematic

Package Outline

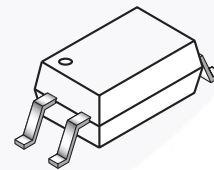

Figure 2. Package Outlines

Safety and Insulation Ratings

As per DIN EN/IEC 60747-5-5, this optocoupler is suitable for “safe electrical insulation” only within the safety limit data. Compliance with the safety ratings shall be ensured by means of protective circuits.

Parameter		Characteristics
Installation Classifications per DIN VDE 0110/1.89 Table 1, For Rated Mains Voltage	< 150 V _{RMS}	I–IV
	< 300 V _{RMS}	I–III
Climatic Classification		55/100/21
Pollution Degree (DIN VDE 0110/1.89)		2
Comparative Tracking Index		175

Symbol	Parameter	Value	Unit
V _{PR}	Input-to-Output Test Voltage, Method A, V _{IORM} × 1.6 = V _{PR} , Type and Sample Test with t _m = 10 s, Partial Discharge < 5 pC	904	V _{peak}
	Input-to-Output Test Voltage, Method B, V _{IORM} × 1.875 = V _{PR} , 100% Production Test with t _m = 1 s, Partial Discharge < 5 pC	1060	V _{peak}
V _{IORM}	Maximum Working Insulation Voltage	565	V _{peak}
V _{IOTM}	Highest Allowable Over-Voltage	4000	V _{peak}
	External Creepage	≥ 5	mm
	External Clearance	≥ 5	mm
DTI	Distance Through Insulation (Insulation Thickness)	≥ 0.4	mm
T _S	Case Temperature ⁽¹⁾	150	°C
I _{S,INPUT}	Input Current ⁽¹⁾	200	mA
P _{S,OUTPUT}	Output Power ⁽¹⁾	300	mW
R _{IO}	Insulation Resistance at T _S , V _{IO} = 500 V ⁽¹⁾	> 10 ⁹	Ω

Note:

1. Safety limit values – maximum values allowed in the event of a failure.

Absolute Maximum Ratings

Stresses exceeding the absolute maximum ratings may damage the device. The device may not function or be operable above the recommended operating conditions and stressing the parts to these levels is not recommended. In addition, extended exposure to stresses above the recommended operating conditions may affect device reliability. The absolute maximum ratings are stress ratings only.

Symbol	Parameter	Value	Units
TOTAL PACKAGE			
T_{STG}	Storage Temperature	-55 to +125	°C
T_{OPR}	Operating Temperature	-55 to +100	°C
T_J	Junction Temperature	-40 to +125	°C
P_D	Total Device Power Dissipation @ $T_A = 25^\circ\text{C}$	210	mW
	Derate Above 25°C	2.1	mW/°C
EMITTER			
I_F (avg)	Continuous Forward Current	50	mA
I_F (pk)	Peak Forward Current (1 μs pulse, 300 pps)	1	A
V_R	Reverse Input Voltage	6	V
P_D	LED Power Dissipation @ $T_A = 25^\circ\text{C}$	60	mW
	Derate Above 25°C	0.6	mW/°C
DETECTOR			
I_C	Continuous Collector Current	50	mA
V_{CEO}	Collector-Emitter Voltage	80	V
V_{ECO}	Emitter-Collector Voltage	7	V
P_D	Detector Power Dissipation @ $T_A = 25^\circ\text{C}$	150	mW
	Derate Above 25°C	1.5	mW/°C

Electrical Characteristics

 $T_A = 25^\circ\text{C}$

Symbol	Parameter	Test Conditions	Device	Min.	Typ.	Max.	Unit
INDIVIDUAL COMPONENT CHARACTERISTICS							
Emitter							
V_F	Forward Voltage	$I_F = 10\text{ mA}$	All	1.0		1.3	V
I_R	Reverse Current	$V_R = 5\text{ V}$	All			5	μA
Detector							
BV_{CEO}	Breakdown Voltage Collector to Emitter	$I_C = 0.5\text{ mA}, I_F = 0$	All	80			V
BV_{ECO}	Emitter to Collector	$I_E = 100\text{ }\mu\text{A}, I_F = 0$	All	7			
I_{CEO}	Collector Dark Current	$V_{CE} = 80\text{ V}, I_F = 0$	All			100	nA
C_{CE}	Capacitance	$V_{CE} = 0\text{ V}, f = 1\text{ MHz}$	All		10		pF
TRANSFER CHARACTERISTICS							
CTR	DC Current Transfer Ratio	$I_F = 5\text{ mA}, V_{CE} = 5\text{ V}$	HMHA281	50		600	%
			HMHA2801	80		600	
			HMHA2801A	80		160	
			HMHA2801B	130		260	
			HMHA2801C	200		400	
$V_{CE(SAT)}$	Saturation Voltage	$I_F = 8\text{ mA}, I_C = 2.4\text{ mA}$	HMHA281			0.4	V
		$I_F = 10\text{ mA}, I_C = 2\text{ mA}$	HMHA2801, HMHA2801A, HMHA2801B, HMHA2801C			0.3	
t_r	Rise Time (Non-Saturated)	$I_C = 2\text{ mA}, V_{CE} = 5\text{ V},$ $R_L = 100\text{ }\Omega$	All		3		μs
t_f	Fall Time (Non-Saturated)	$I_C = 2\text{ mA}, V_{CE} = 5\text{ V},$ $R_L = 100\text{ }\Omega$	All		3		
ISOLATION CHARACTERISTICS							
V_{ISO}	Steady State Isolation Voltage	1 Minute	All	3750			$V_{AC_{RMS}}$

Typical Performance Characteristics

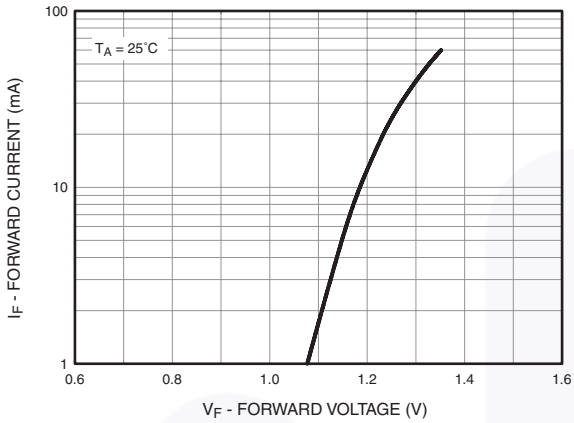

Figure 3. Forward Current vs. Forward Voltage

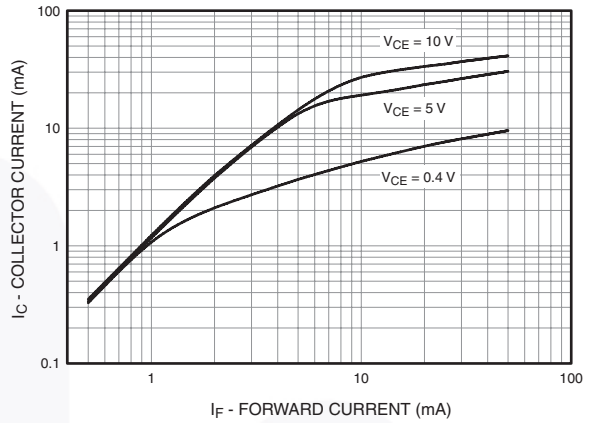

Figure 4. Collector Current vs. Forward Current

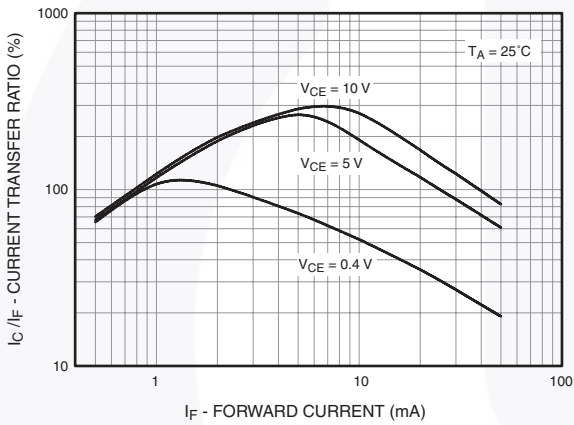

Figure 5. Current Transfer Ratio vs. Forward Current

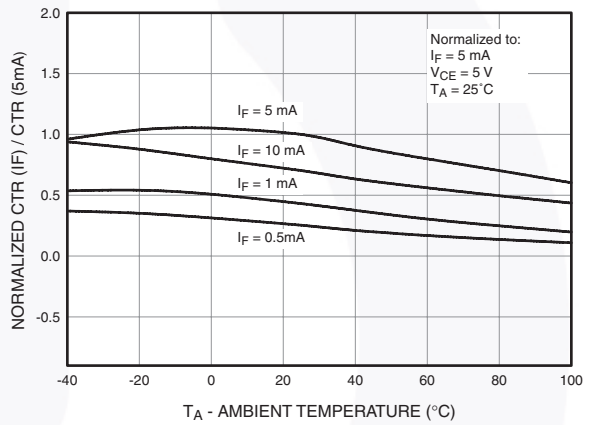

Figure 6. Normalized CTR vs. Temperature

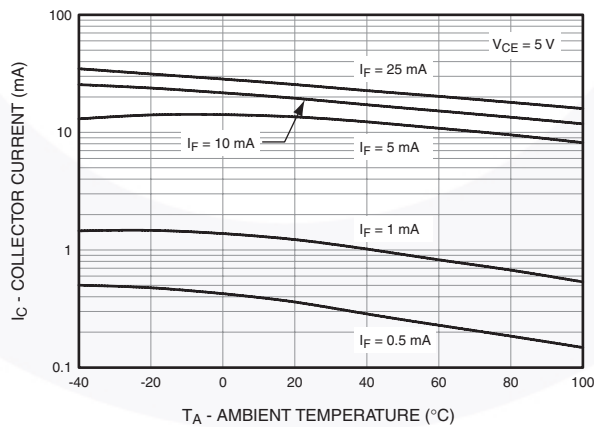

Figure 7. Collector Current vs. Temperature

Typical Performance Characteristics (Continued)

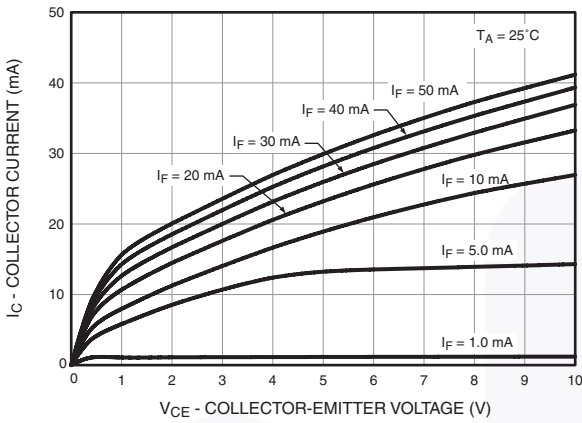

Figure 8. Collector Current vs. Collector-Emitter Voltage

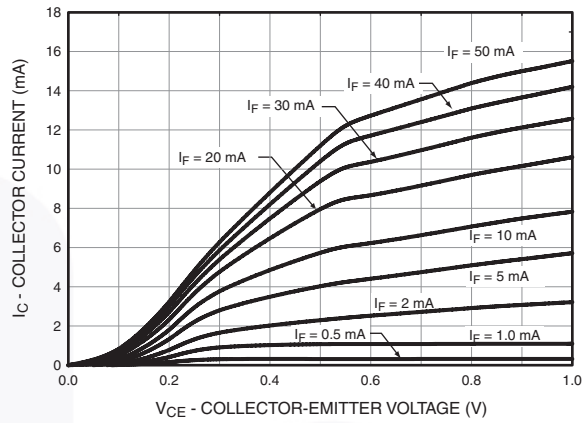

Figure 9. Collector Current vs. Collector-Emitter Voltage

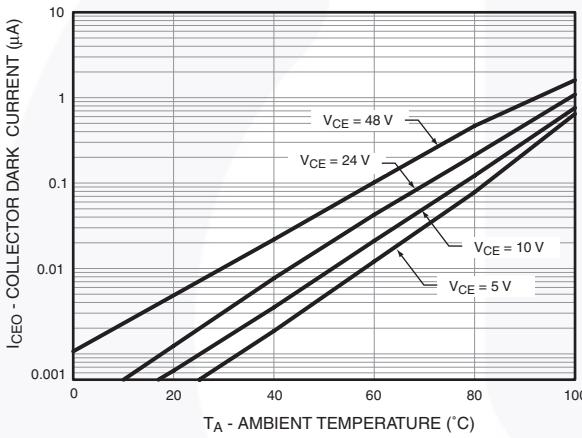

Figure 10. Collector Dark Current vs. Temperature

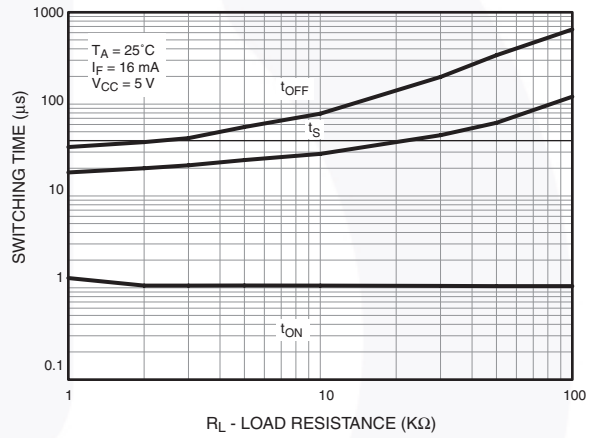

Figure 11. Switching Time vs. Load Resistance

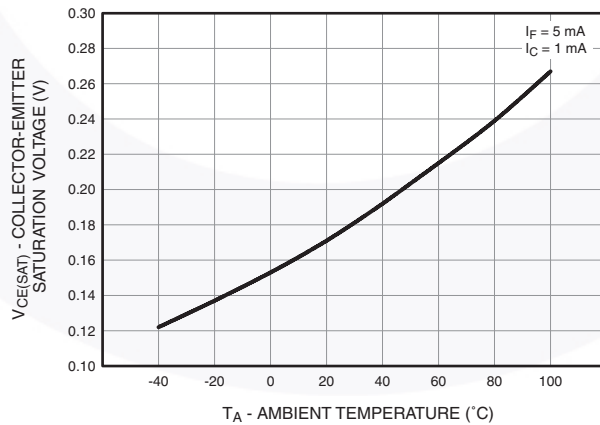

Figure 12. Collector-Emitter Saturation Voltage vs. Temperature

Reflow Profile

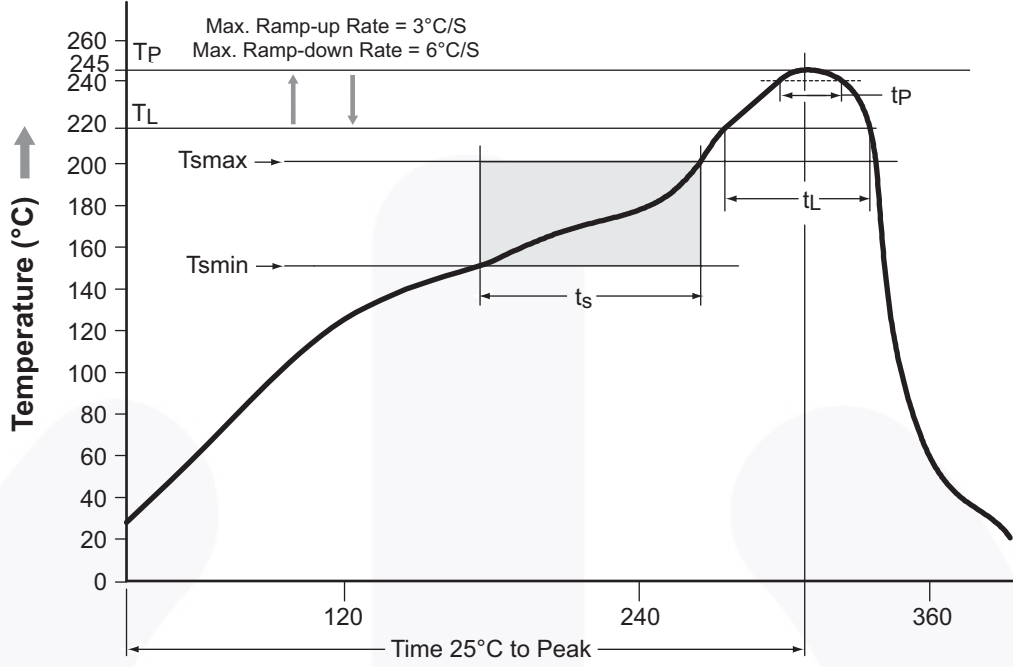

Figure 13. Reflow Profile

Profile Feature	Pb-Free Assembly Profile
Temperature Minimum (T _{smin})	150°C
Temperature Maximum (T _{smax})	200°C
Time (t _s) from (T _{smin} to T _{smax})	60–120 seconds
Ramp-up Rate (t _L to t _P)	3°C/second maximum
Liquidous Temperature (T _L)	217°C
Time (t _L) Maintained Above (T _L)	60–150 seconds
Peak Body Package Temperature	245°C +0°C / -5°C
Time (t _P) within 5°C of 245°C	30 seconds
Ramp-down Rate (T _P to T _L)	6°C/second maximum
Time 25°C to Peak Temperature	8 minutes maximum

Ordering Information

Part Number	Package	Packing Method
HMHA2801	Half Pitch Mini-Flat 4-Pin	Tube (100 units)
HMHA2801R2	Half Pitch Mini-Flat 4-Pin	Tape and Reel (2500 Units)
HMHA2801V	Half Pitch Mini-Flat 4-Pin, DIN EN/IEC60747-5-5 Option	Tube (100 Units)
HMHA2801R2V	Half Pitch Mini-Flat 4-Pin, DIN EN/IEC60747-5-5 Option	Tape and Reel (2500 Units)

Note:

2. The product orderable part number system listed in this table also applies to the HMHA281, HMHA2801A, HMHA2801B, and HMHA2801C products.

Marking Information

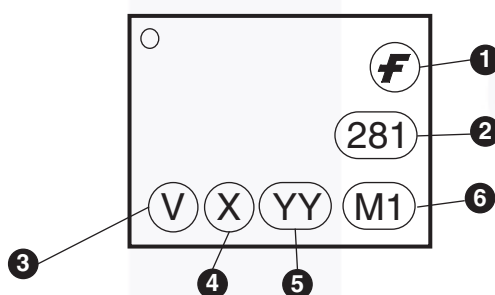
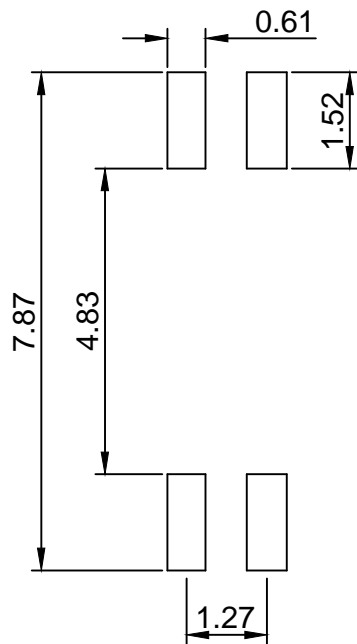
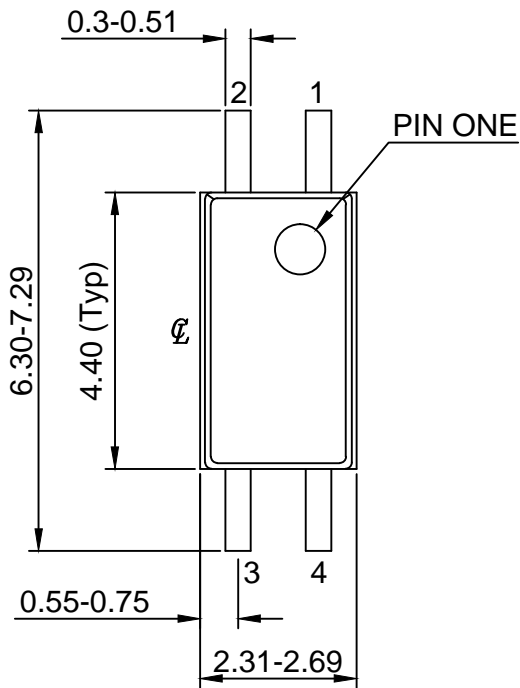

Figure 14. Top Mark

Table 1. Top Mark Definitions

1	Fairchild Logo
2	Device Number
3	DIN EN/IEC60747-5-5 Option (only appears on component ordered with this option)
4	One-Digit Year Code, e.g., "5"
5	Digit Work Week, Ranging from "01" to "53"
6	Assembly Package Code



LAND PATTERN RECOMMENDATION

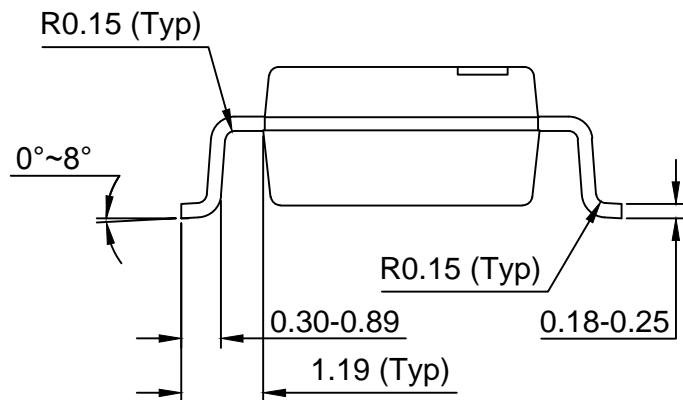
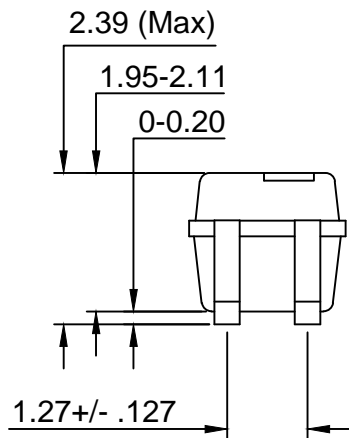

NOTES:

- A) NO STANDARD APPLIES TO THIS PACKAGE
- B) ALL DIMENSIONS ARE IN MILLIMETERS.
- C) DIMENSIONS ARE EXCLUSIVE OF BURRS, MOLD FLASH, AND TIE BAR EXTRUSION
- D) DRAWING FILENAME AND REVISION : MKT-MFP04AREV4.



ON Semiconductor and  are trademarks of Semiconductor Components Industries, LLC dba ON Semiconductor or its subsidiaries in the United States and/or other countries. ON Semiconductor owns the rights to a number of patents, trademarks, copyrights, trade secrets, and other intellectual property. A listing of ON Semiconductor's product/patent coverage may be accessed at www.onsemi.com/site/pdf/Patent-Marking.pdf. ON Semiconductor reserves the right to make changes without further notice to any products herein. ON Semiconductor makes no warranty, representation or guarantee regarding the suitability of its products for any particular purpose, nor does ON Semiconductor assume any liability arising out of the application or use of any product or circuit, and specifically disclaims any and all liability, including without limitation special, consequential or incidental damages. Buyer is responsible for its products and applications using ON Semiconductor products, including compliance with all laws, regulations and safety requirements or standards, regardless of any support or applications information provided by ON Semiconductor. "Typical" parameters which may be provided in ON Semiconductor data sheets and/or specifications can and do vary in different applications and actual performance may vary over time. All operating parameters, including "Typicals" must be validated for each customer application by customer's technical experts. ON Semiconductor does not convey any license under its patent rights nor the rights of others. ON Semiconductor products are not designed, intended, or authorized for use as a critical component in life support systems or any FDA Class 3 medical devices or medical devices with a same or similar classification in a foreign jurisdiction or any devices intended for implantation in the human body. Should Buyer purchase or use ON Semiconductor products for any such unintended or unauthorized application, Buyer shall indemnify and hold ON Semiconductor and its officers, employees, subsidiaries, affiliates, and distributors harmless against all claims, costs, damages, and expenses, and reasonable attorney fees arising out of, directly or indirectly, any claim of personal injury or death associated with such unintended or unauthorized use, even if such claim alleges that ON Semiconductor was negligent regarding the design or manufacture of the part. ON Semiconductor is an Equal Opportunity/Affirmative Action Employer. This literature is subject to all applicable copyright laws and is not for resale in any manner.

PUBLICATION ORDERING INFORMATION

LITERATURE FULFILLMENT:

Literature Distribution Center for ON Semiconductor
19521 E. 32nd Pkwy, Aurora, Colorado 80011 USA
Phone: 303-675-2175 or 800-344-3860 Toll Free USA/Canada
Fax: 303-675-2176 or 800-344-3867 Toll Free USA/Canada
Email: orderlit@onsemi.com

N. American Technical Support: 800-282-9855 Toll Free
USA/Canada
Europe, Middle East and Africa Technical Support:
Phone: 421 33 790 2910
Japan Customer Focus Center
Phone: 81-3-5817-1050

ON Semiconductor Website: www.onsemi.com
Order Literature: <http://www.onsemi.com/orderlit>
For additional information, please contact your local
Sales Representative