



Is Now Part of



ON Semiconductor®

To learn more about ON Semiconductor, please visit our website at
www.onsemi.com

ON Semiconductor and the ON Semiconductor logo are trademarks of Semiconductor Components Industries, LLC dba ON Semiconductor or its subsidiaries in the United States and/or other countries. ON Semiconductor owns the rights to a number of patents, trademarks, copyrights, trade secrets, and other intellectual property. A listing of ON Semiconductor's product/patent coverage may be accessed at www.onsemi.com/site/pdf/Patent-Marking.pdf. ON Semiconductor reserves the right to make changes without further notice to any products herein. ON Semiconductor makes no warranty, representation or guarantee regarding the suitability of its products for any particular purpose, nor does ON Semiconductor assume any liability arising out of the application or use of any product or circuit, and specifically disclaims any and all liability, including without limitation special, consequential or incidental damages. Buyer is responsible for its products and applications using ON Semiconductor products, including compliance with all laws, regulations and safety requirements or standards, regardless of any support or applications information provided by ON Semiconductor. "Typical" parameters which may be provided in ON Semiconductor data sheets and/or specifications can and do vary in different applications and actual performance may vary over time. All operating parameters, including "Typicals" must be validated for each customer application by customer's technical experts. ON Semiconductor does not convey any license under its patent rights nor the rights of others. ON Semiconductor products are not designed, intended, or authorized for use as a critical component in life support systems or any FDA Class 3 medical devices or medical devices with a same or similar classification in a foreign jurisdiction or any devices intended for implantation in the human body. Should Buyer purchase or use ON Semiconductor products for any such unintended or unauthorized application, Buyer shall indemnify and hold ON Semiconductor and its officers, employees, subsidiaries, affiliates, and distributors harmless against all claims, costs, damages, and expenses, and reasonable attorney fees arising out of, directly or indirectly, any claim of personal injury or death associated with such unintended or unauthorized use, even if such claim alleges that ON Semiconductor was negligent regarding the design or manufacture of the part. ON Semiconductor is an Equal Opportunity/Affirmative Action Employer. This literature is subject to all applicable copyright laws and is not for resale in any manner.



FAN3989

USB/Charger Detection Device with Load Switch

Features

- Charger/USB Detection Device with Load Switch
- Charger/USB Device Detection Flag
- Over/Under-Voltage Detection Flag
- Load Switch Output, Up to 1.5A Charge Current
- V_{BUS} Supply: 2.7V to 20V
- C_{ON} : 1.5pF
- Package: 8-Lead MLP

Applications

- Mobile Phones
- Handheld Devices

Related Resources

- [AN-5067 — PCB Land Pattern Design and Surface Mount Guidelines for MLP Packages](#)

Description

The FAN3989 is a USB connection monitoring device used to determine if a standard USB device is connected or a battery-charging device is connected.

The FAN3989 sets the FLAG1 pin to logic HIGH or LOW as an indicator to the system controller that a standard USB device or a charger is connected to the USB port. The FAN3989 also monitors the V_{BUS} for over- or under-voltage conditions. The FLAG2 pin is set LOW if V_{BUS} is less than 3.3V or greater than 6.0V. The internal load switch control pin is set HIGH if V_{BUS} is less than 3.3V or greater than 6.0V, turning off the PMOS switch.

The FAN3989 is available in a very small 8-lead MLP package suitable for small board space applications, like mobile phones.

Ordering Information

Part Number	Operating Temperature Range	Package	Packing Method	Quantity
FAN3989MLP8X	-40°C to +85°C	8-Lead Molded Leadless Package (MLP)	Reel	3000

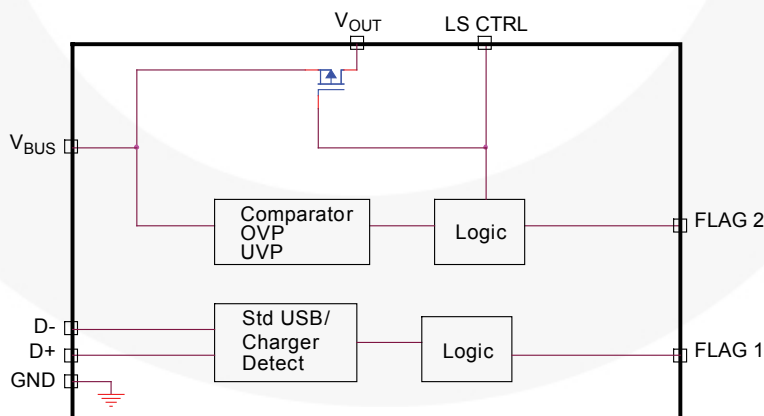

Figure 1. Block Diagram

Pin Configuration

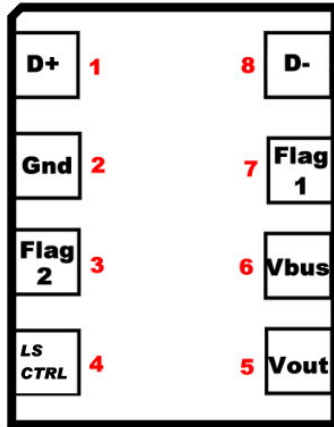

Figure 2. Pin Configuration (Top View)

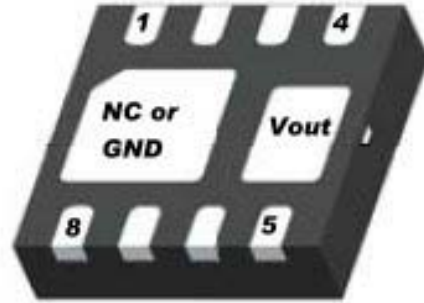

Figure 3. Pin Configuration (Bottom View)

Pin Definitions

Pin#	Name	Type	Description
1	D+	Input	USB Data Input
2	GND	Input	Device Ground
3	Flag2	Output	Over-/Under-Voltage Flag Output
4	LSCTRL	Output	PMOS Switch Control – Pull-Up Connection to V_{BUS}
5	V_{OUT}	Output	Voltage Out – Connection also on Package DAP (see <i>PCB Layout Guideline section</i>)
6	V_{BUS}	Input	Power Input from Charger, USB Device, or Handheld Battery
7	Flag1	Output	Charger / Standard USB Device Detect Flag
8	D-	Input	USB Data Input

Truth Table

Connection State	V_{BUS}	D-	D+	FLAG1	FLAG2	LS CTRL	Description
STD USB Device	0V	R to GND	R to VDD	LOW	LOW	HIGH	Load switch open
STD USB Device	5V	R to GND	R to VDD	LOW	HIGH	LOW	Load switch closed
USB Charger	5V	Short to D+	Short to D-	HIGH	HIGH	LOW	Normal state, load switch closed
V_{BUS} GT 6V	GT 6V	Short to D+	Short to D-	HIGH	LOW	HIGH	Load switch open
V_{BUS} LT 3.3V	LT 3.3V	Short to D+	Short to D-	HIGH	LOW	HIGH	Load switch open
PC Charger	5V	Open	Open	LOW	HIGH	LOW	Load switch closed

Absolute Maximum Ratings

Stresses exceeding the absolute maximum ratings may damage the device. The device may not function or be operable above the recommended operating conditions and stressing the parts to these levels is not recommended. In addition, extended exposure to stresses above the recommended operating conditions may affect device reliability. The absolute maximum ratings are stress ratings only.

Symbol	Parameter	Min.	Max.	Unit
V_S	DC Supply Voltage	-0.3	20.0	V
V_{IO}	Analog and Digital I/O	-0.3	$V_{CC}+0.3$	V

Reliability Information

Symbol	Parameter	Min.	Typ.	Max.	Unit
T_J	Junction Temperature			+150	°C
T_{STG}	Storage Temperature Range	-65		+150	°C
Θ_{JA}	Thermal Resistance, JEDEC Standard, Multilayer Test Boards, Still Air		41		°C/W

Electrostatic Discharge Information

Symbol	Parameter	Max.	Unit
ESD	Human Body Model, JESD22-A114	3	kV
	Charged Device Model, JESD22-C101	1	

Recommended Operating Conditions

The Recommended Operating Conditions table defines the conditions for actual device operation. Recommended operating conditions are specified to ensure optimal performance to the datasheet specifications. Fairchild does not recommend exceeding them or designing to Absolute Maximum Ratings.

Symbol	Parameter	Min.	Typ.	Max.	Unit
T_A	Operating Temperature Range	-40		+85	°C
V_{CC}	Supply Voltage Range	2.7	5.0	20.0	V

DC Electrical Characteristics

$T_A = 25^\circ\text{C}$, $V_{CC} = 5.0\text{V}$, unless otherwise noted.

Symbol	Parameter	Conditions	Min.	Typ.	Max.	Units
Supply						
V_S	Supply Voltage Range	V_S Range	2.7	5.0	20.0	V
I_{CC}	Quiescent Supply Current	$V_S = +5.0\text{V}$, D+ D- Shorted		1.2	2.0	mA
t_{SUPPLY}	Power-Up Stabilization Time	$V_S = +5.0\text{V}$, D+ D- Shorted		10		ms
Input Characteristics						
C_{D+}	Input Capacitance			1.5	2.0	pF
C_{D-}	Input Capacitance			1.5	2.0	pF
$I_{off\ D+}$	Off Leakage Current	$V_{BUS} = 0\text{V}$ or 5V V_{IN} on D+ = 5V		1		μA
$I_{off\ D-}$	Off Leakage Current	$V_{BUS} = 0\text{V}$ or 5V V_{IN} on D- = 5V		1		μA
Output Characteristics						
OV_{DETECT}	Over-Voltage Threshold Detect	$V_S = +5.0\text{V}$, Flag2 = LOW	5.8	6.2	6.5	V
OV_{HYST}	Over-Voltage Hysteresis	Voltage Sweep through Upper and Lower Trip Points		100		mV
UV_{DETECT}	Under-Voltage Threshold Detect	$V_S = +5.0\text{V}$, Flag2 = LOW	3.0	3.3	3.6	V
UV_{HYST}	Under-Voltage Hysteresis	Voltage Sweep through Upper and Lower Trip Points		100		mV
$V_{OH\ FLAG1/FLAG2}$	Minimum HIGH Output Voltage	$V_S = +5.0\text{V}$, $I_{OH} = -20\mu\text{A}$	2.4			V
$V_{OL\ FLAG1/FLAG2}$	Maximum LOW Output Voltage	$V_S = +5.0\text{V}$, $I_{OL} = 20\mu\text{A}$			0.3	V
$V_{OL\ LS_CTRL}$	Maximum LOW Output Voltage	$V_S = +5.0\text{V}$, $I_{OL} = 100\mu\text{A}$			0.3	V
VB_{DSS}	Drain Source Breakdown Voltage	$V_{GS} = 0\text{V}$, $I_D = -250\mu\text{A}$	-20			V
R_{DSON}	Static Drain-Source On Resistance	$V_{GS} = -5.0\text{V}$, $I_P = 1\text{A}$		186		m Ω
C_{iss}	Input Capacitance	$V_{DS} = -10\text{V}$, $V_{GS} = 0\text{V}$, $f = 1.0\text{MHz}$		330		pF
C_{oss}	Output Capacitance			80		pF
$t_{d(on)}$	PMOS Turn-On Delay Time	$V_{DD} = -5\text{V}$, $I_P = -0.5\text{A}$,		5		μs
$t_{d(off)}$	PMOS Turn-Off Delay Time	$V_{GS} = -4.5\text{V}$, $R_{GEN} = 6\Omega$		14		μs

Typical Performance Characteristics

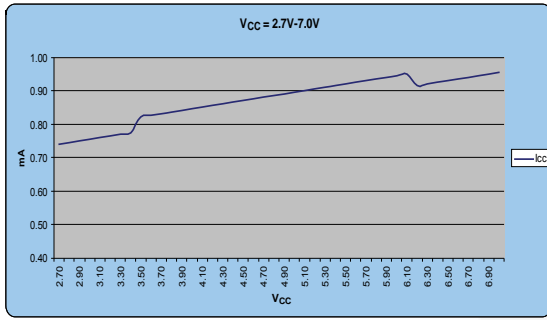

Figure 4. I_{CC} vs. V_{CC} (2.7V-7.0V) No Load

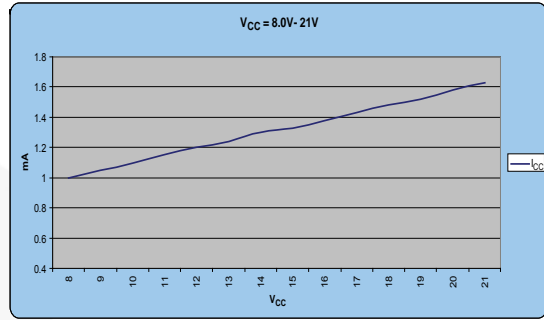

Figure 5. I_{CC} vs. V_{CC} (8.0V-21V) No Load

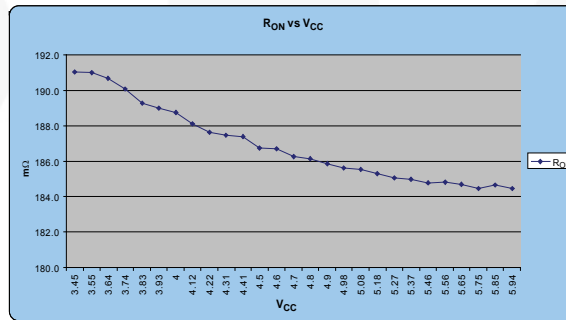

Figure 6. R_{ON} vs. V_{CC} (10Ω Load)

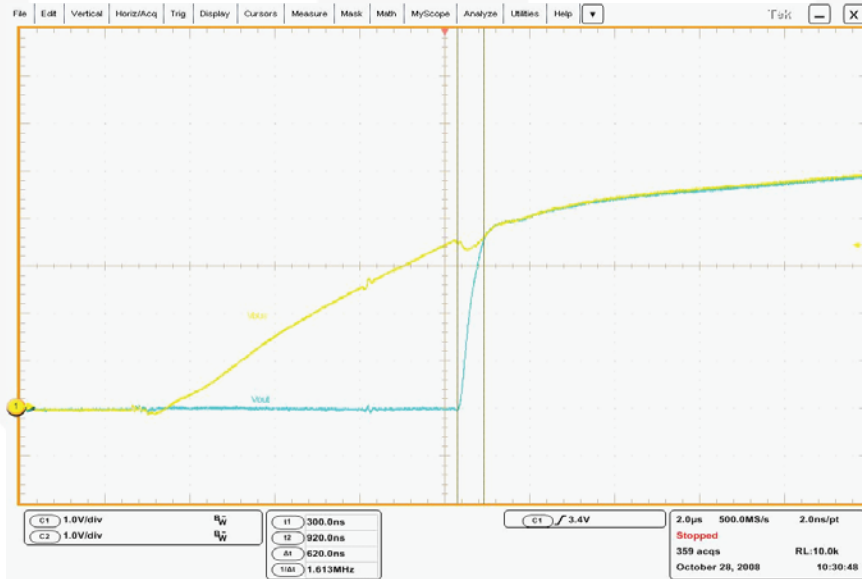

Figure 7. Turn-On Time

Typical Performance Characteristics (Continued)

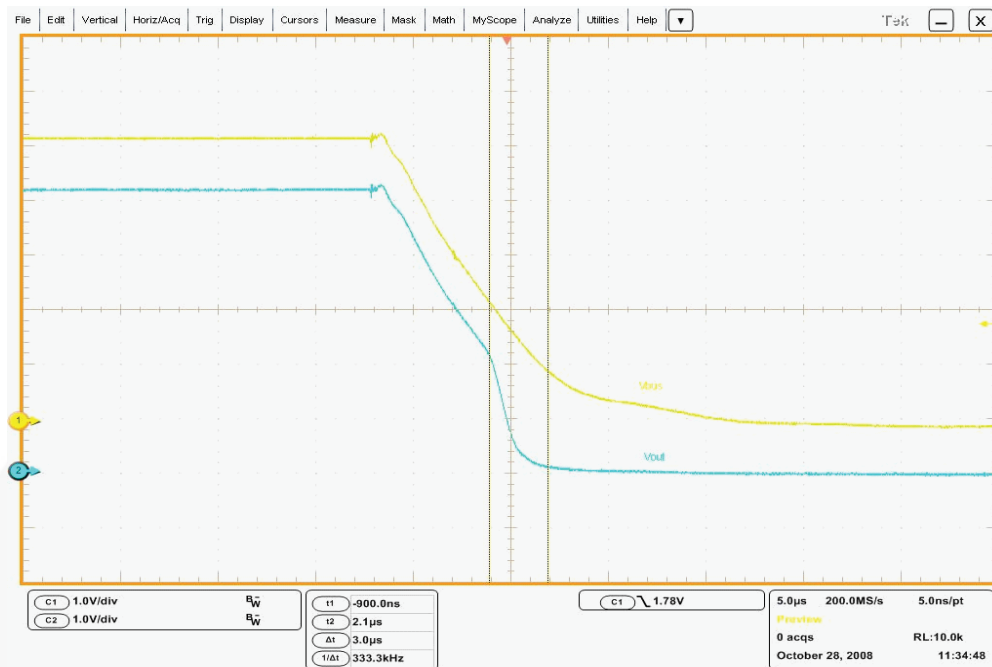

Figure 8. Turn-Off Time

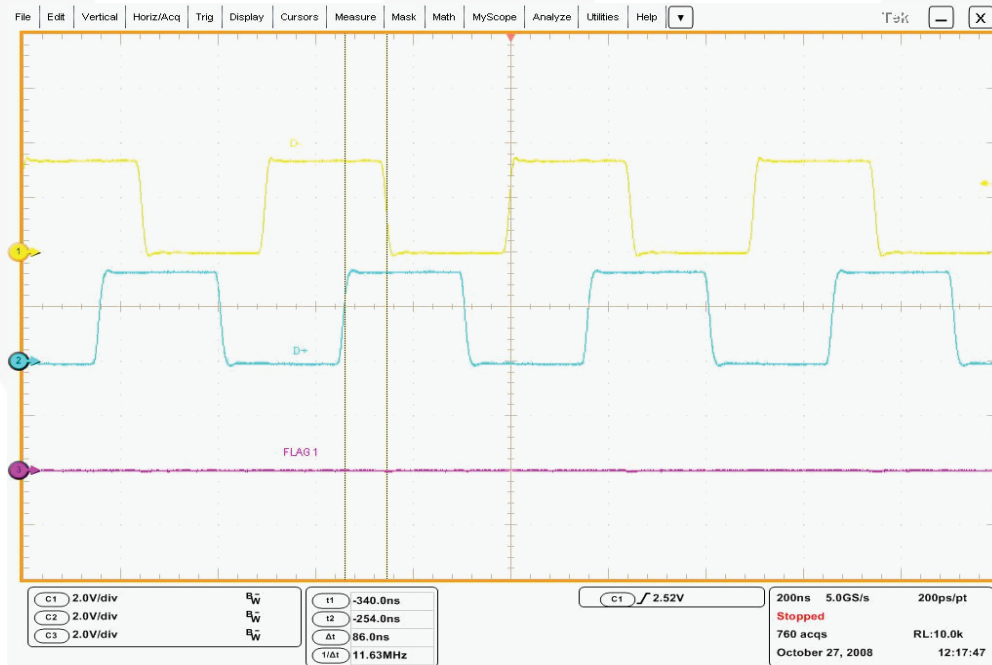

Figure 9. No Fault on Flag 1, Skew=65ns

Typical Performance Characteristics (Continued)

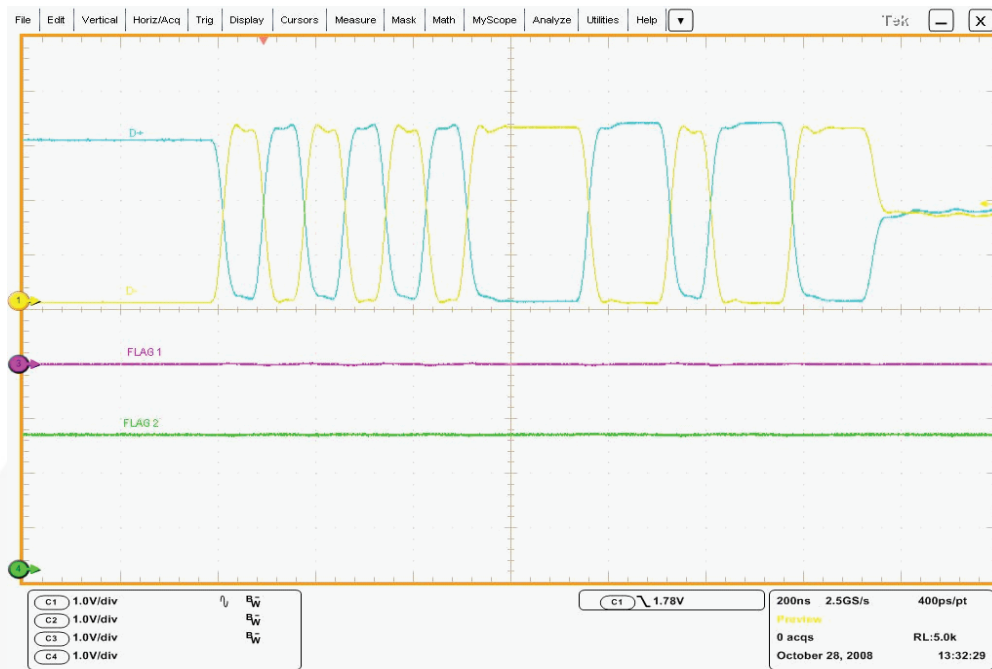

Figure 10. PC Data Running D+/D- (Flag 1 and Flag 2 at Correct Levels)



Figure 11. Standard USB Charger Plug-In

Applications Information (Continued)

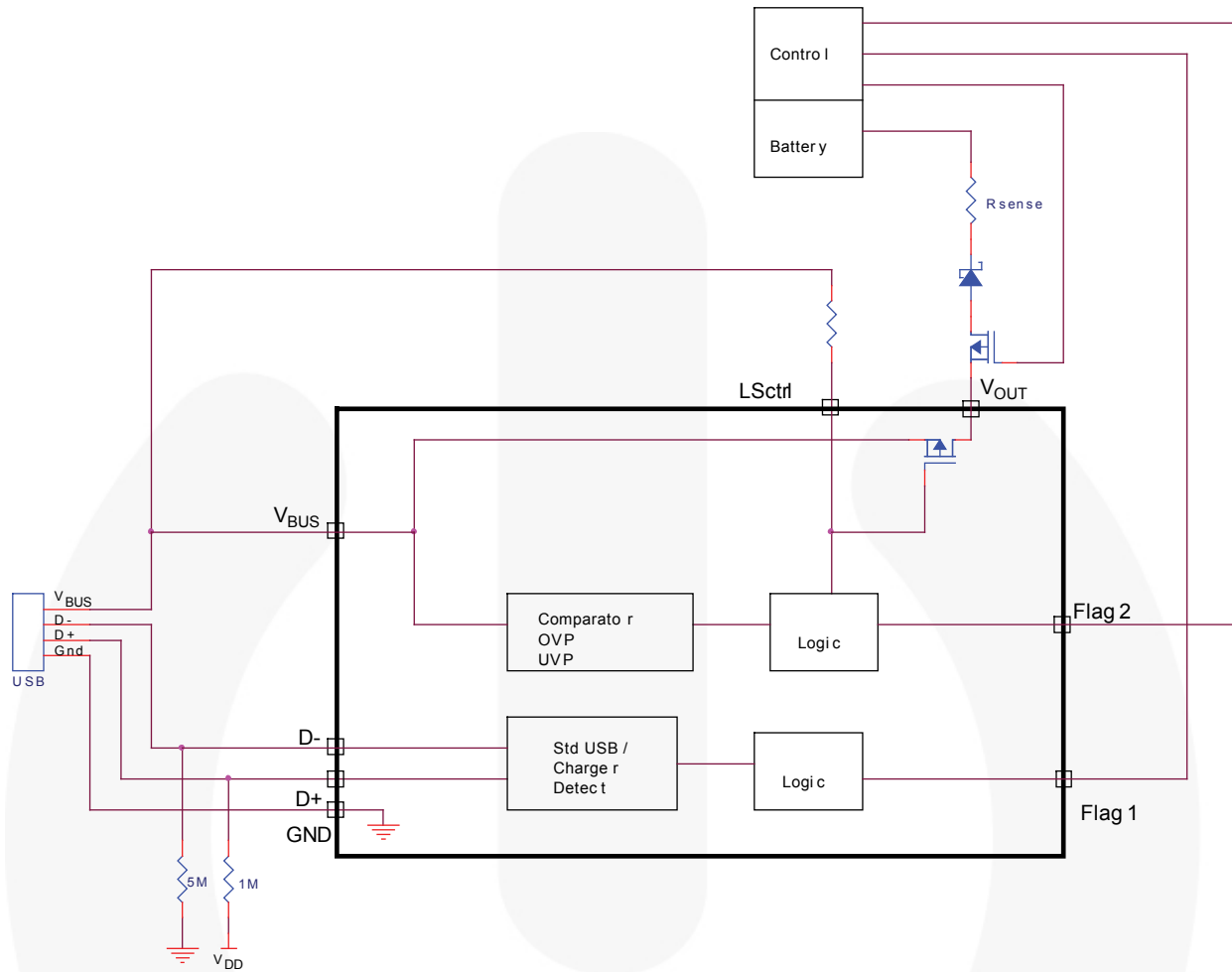

Figure 13. Mobile Phone Battery Charging System without USB Interface

The FAN3989 sets the FLAG1 pin to logic HIGH or LOW as an indicator to the system controller that a standard USB device or a charger is connected to the USB port. The FAN3989 also monitors the V_{BUS} for over- or under-voltage conditions. If V_{BUS} is less than 3.3V or greater than 6.0V, the FLAG2 pin is set LOW and the internal load switch control pin is set HIGH, turning off the PMOS switch.

Where a USB transceiver is not incorporated or there is a switch between the USB port and the FAN3989, external resistors are used to set the correct input logic states on the D+ and D- inputs. A 5M Ω pull-down on the D- line and a 1M Ω pull-up to V_{DD} on the D+ line are recommended. If a charger is plugged into

the USB port (D+ and D- shorted), the voltage divider of 1M and 5M put a voltage of 2.3V on the D+D- inputs and flag1 is HIGH, indicating a charger is connected to port.

If the USB port is connected to a standard USB device, the D+ input is pulled up to V_{DD} and is in parallel with the 1.5K Ω on a USB transceiver with a parallel R value of 1.497K Ω . The D- input is connected to a 15K Ω pull-down by the USB device and in parallel with 5M Ω with a parallel R value of 14.955K Ω . This condition forces flag1 LOW. If D+ and D- are open (floating), D+ is pulled to V_{DD} and D- floats LOW, which forces flag1 LOW.

PCB Layout Guidelines

Please also see Fairchild Semiconductor applications note AN-5067 — PCB Land Pattern Design and Surface Mount Guidelines for MLP Packages

Pad1

This exposed DAP is connected to the internal FET drain and labeled V_{OUT} on the device. The pad should be connected to V_{OUT} pin of the device or left floating. It

should never be connected to the ground, power plane, or Pad2.

Pad2

This exposed DAP is connected to an internal die substrate that is at a ground potential. The pad should be left floating or can be connected to ground plane. This pad should never be connected to Pad1 or the power plane.

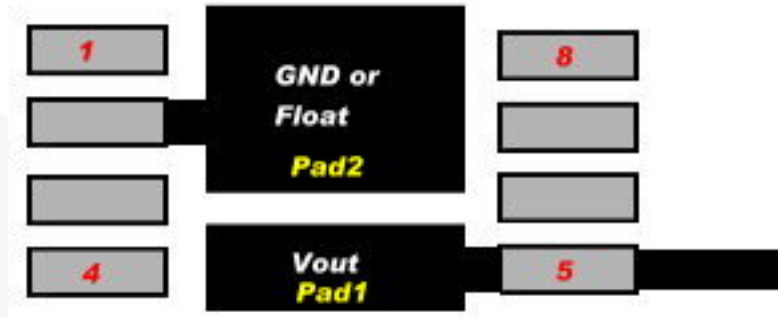

Figure 14. PCD / Pad Layout

Physical Dimensions

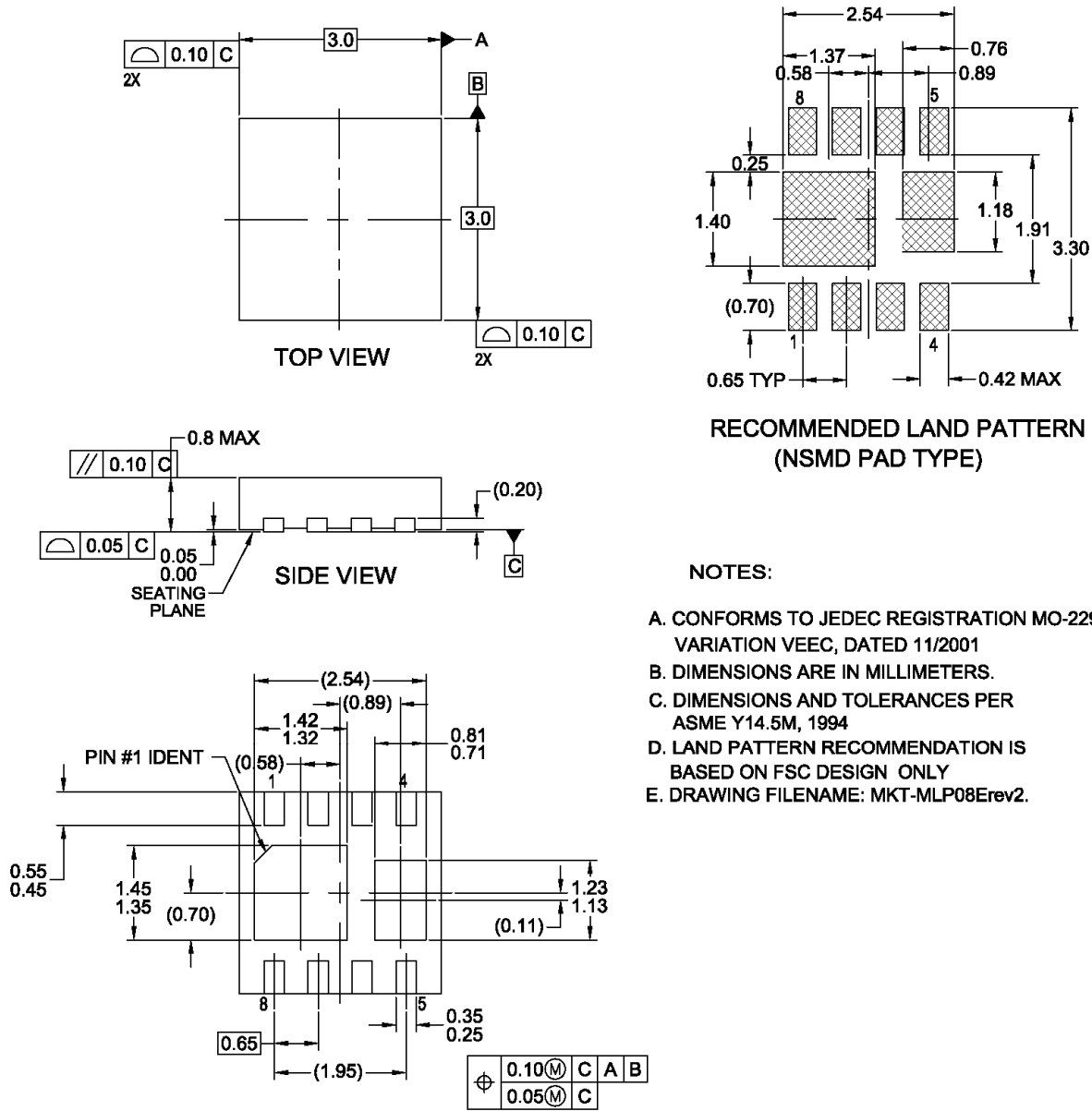

Figure 15. 8-Lead Molded Leadless Package (MLP)





Package drawings are provided as a service to customers considering Fairchild components. Drawings may change in any manner without notice. Please note the revision and/or date on the drawing and contact a Fairchild Semiconductor representative to verify or obtain the most recent revision. Package specifications do not expand the terms of Fairchild's worldwide terms and conditions, specifically the warranty therein, which covers Fairchild products.

Always visit Fairchild Semiconductor's online packaging area for the most recent package drawings:
<http://www.fairchildsemi.com/packaging/>



TRADEMARKS

The following includes registered and unregistered trademarks and service marks, owned by Fairchild Semiconductor and/or its global subsidiaries, and is not intended to be an exhaustive list of all such trademarks.

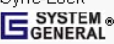
AccuPower™	F-PFS™	Power-SPM™	The Power Franchise®
Auto-SPM™	FRFET®	PowerTrench®	The Right Technology for Your Success™
AX-CAPT™*	Global Power Resource SM	PowerXS™	the power franchise
Build it Now™	Green FPST™	Programmable Active Droop™	TinyBoost™
CorePLUS™	Green FPST™ e-Series™	QFET®	TinyBuck™
CorePOWER™	Gmax™	QS™	TinyCalc™
CROSSVOL™	GTO™	Quiet Series™	TinyLogic®
CTL™	IntelliMAX™	RapidConfigure™	TINYOPTO™
Current Transfer Logic™	ISOPLANAR™		TinyPower™
DEUXPEED®	MegaBuck™	Saving our world, 1mW/kW at a time™	TinyPower™
Dual Cool™	MICROCOUPLER™	SignalWise™	TinyPWM™
EcoSPARK®	MicroFET™	SmartMax™	TinyWire™
EfficientMax™	MicroPak™	SMART START™	TriFault Detect™
ESBC™	MicroPak2™	SPM®	TRUECURRENT®*
	MillerDrive™	STEALTH™	µSerDes™
Fairchild®	MotionMax™	SuperFET®	
Fairchild Semiconductor®	Motion-SPM™	SuperSOT™-3	UHC®
FACT Quiet Series™	mWSaver™	SuperSOT™-6	Ultra FRFET™
FACT®	OptoHIT™	SuperSOT™-8	UniFET™
FAST®	OPTOLOGIC®	SupreMOS®	VCX™
FastvCore™	OPTOPLANAR®	SyncFET™	VisualMax™
FETBench™		Sync-Lock™	XS™
FlashWriter®*	PDP SPM™		
FPST™			

* Trademarks of System General Corporation, used under license by Fairchild Semiconductor.

DISCLAIMER

FAIRCHILD SEMICONDUCTOR RESERVES THE RIGHT TO MAKE CHANGES WITHOUT FURTHER NOTICE TO ANY PRODUCTS HEREIN TO IMPROVE RELIABILITY, FUNCTION, OR DESIGN. FAIRCHILD DOES NOT ASSUME ANY LIABILITY ARISING OUT OF THE APPLICATION OR USE OF ANY PRODUCT OR CIRCUIT DESCRIBED HEREIN; NEITHER DOES IT CONVEY ANY LICENSE UNDER ITS PATENT RIGHTS, NOR THE RIGHTS OF OTHERS. THESE SPECIFICATIONS DO NOT EXPAND THE TERMS OF FAIRCHILD'S WORLDWIDE TERMS AND CONDITIONS, SPECIFICALLY THE WARRANTY THEREIN, WHICH COVERS THESE PRODUCTS.

LIFE SUPPORT POLICY

FAIRCHILD'S PRODUCTS ARE NOT AUTHORIZED FOR USE AS CRITICAL COMPONENTS IN LIFE SUPPORT DEVICES OR SYSTEMS WITHOUT THE EXPRESS WRITTEN APPROVAL OF FAIRCHILD SEMICONDUCTOR CORPORATION.

As used herein:

- Life support devices or systems are devices or systems which, (a) are intended for surgical implant into the body or (b) support or sustain life, and (c) whose failure to perform when properly used in accordance with instructions for use provided in the labeling, can be reasonably expected to result in a significant injury of the user.
- A critical component in any component of a life support, device, or system whose failure to perform can be reasonably expected to cause the failure of the life support device or system, or to affect its safety or effectiveness.

ANTI-COUNTERFEITING POLICY

Fairchild Semiconductor Corporation's Anti-Counterfeiting Policy. Fairchild's Anti-Counterfeiting Policy is also stated on our external website, www.fairchildsemi.com, under Sales Support.

Counterfeiting of semiconductor parts is a growing problem in the industry. All manufacturers of semiconductor products are experiencing counterfeiting of their parts. Customers who inadvertently purchase counterfeit parts experience many problems such as loss of brand reputation, substandard performance, failed applications, and increased cost of production and manufacturing delays. Fairchild is taking strong measures to protect ourselves and our customers from the proliferation of counterfeit parts. Fairchild strongly encourages customers to purchase Fairchild parts either directly from Fairchild or from Authorized Fairchild Distributors who are listed by country on our web page cited above. Products customers buy either from Fairchild directly or from Authorized Fairchild Distributors are genuine parts, have full traceability, meet Fairchild's quality standards for handling and storage and provide access to Fairchild's full range of up-to-date technical and product information. Fairchild and our Authorized Distributors will stand behind all warranties and will appropriately address any warranty issues that may arise. Fairchild will not provide any warranty coverage or other assistance for parts bought from Unauthorized Sources. Fairchild is committed to combat this global problem and encourage our customers to do their part in stopping this practice by buying direct or from authorized distributors.

PRODUCT STATUS DEFINITIONS

Definition of Terms

Datasheet Identification	Product Status	Definition
Advance Information	Formative / In Design	Datasheet contains the design specifications for product development. Specifications may change in any manner without notice.
Preliminary	First Production	Datasheet contains preliminary data; supplementary data will be published at a later date. Fairchild Semiconductor reserves the right to make changes at any time without notice to improve design.
No Identification Needed	Full Production	Datasheet contains final specifications. Fairchild Semiconductor reserves the right to make changes at any time without notice to improve the design.
Obsolete	Not In Production	Datasheet contains specifications on a product that is discontinued by Fairchild Semiconductor. The datasheet is for reference information only.

Rev. 153

ON Semiconductor and  are trademarks of Semiconductor Components Industries, LLC dba ON Semiconductor or its subsidiaries in the United States and/or other countries. ON Semiconductor owns the rights to a number of patents, trademarks, copyrights, trade secrets, and other intellectual property. A listing of ON Semiconductor's product/patent coverage may be accessed at www.onsemi.com/site/pdf/Patent-Marking.pdf. ON Semiconductor reserves the right to make changes without further notice to any products herein. ON Semiconductor makes no warranty, representation or guarantee regarding the suitability of its products for any particular purpose, nor does ON Semiconductor assume any liability arising out of the application or use of any product or circuit, and specifically disclaims any and all liability, including without limitation special, consequential or incidental damages. Buyer is responsible for its products and applications using ON Semiconductor products, including compliance with all laws, regulations and safety requirements or standards, regardless of any support or applications information provided by ON Semiconductor. "Typical" parameters which may be provided in ON Semiconductor data sheets and/or specifications can and do vary in different applications and actual performance may vary over time. All operating parameters, including "Typicals" must be validated for each customer application by customer's technical experts. ON Semiconductor does not convey any license under its patent rights nor the rights of others. ON Semiconductor products are not designed, intended, or authorized for use as a critical component in life support systems or any FDA Class 3 medical devices or medical devices with a same or similar classification in a foreign jurisdiction or any devices intended for implantation in the human body. Should Buyer purchase or use ON Semiconductor products for any such unintended or unauthorized application, Buyer shall indemnify and hold ON Semiconductor and its officers, employees, subsidiaries, affiliates, and distributors harmless against all claims, costs, damages, and expenses, and reasonable attorney fees arising out of, directly or indirectly, any claim of personal injury or death associated with such unintended or unauthorized use, even if such claim alleges that ON Semiconductor was negligent regarding the design or manufacture of the part. ON Semiconductor is an Equal Opportunity/Affirmative Action Employer. This literature is subject to all applicable copyright laws and is not for resale in any manner.

PUBLICATION ORDERING INFORMATION

LITERATURE FULFILLMENT:

Literature Distribution Center for ON Semiconductor
19521 E. 32nd Pkwy, Aurora, Colorado 80011 USA
Phone: 303-675-2175 or 800-344-3860 Toll Free USA/Canada
Fax: 303-675-2176 or 800-344-3867 Toll Free USA/Canada
Email: orderlit@onsemi.com

N. American Technical Support: 800-282-9855 Toll Free
USA/Canada
Europe, Middle East and Africa Technical Support:
Phone: 421 33 790 2910
Japan Customer Focus Center
Phone: 81-3-5817-1050

ON Semiconductor Website: www.onsemi.com
Order Literature: <http://www.onsemi.com/orderlit>
For additional information, please contact your local
Sales Representative