



Is Now Part of



**ON Semiconductor®**

To learn more about ON Semiconductor, please visit our website at  
[www.onsemi.com](http://www.onsemi.com)

ON Semiconductor and the ON Semiconductor logo are trademarks of Semiconductor Components Industries, LLC dba ON Semiconductor or its subsidiaries in the United States and/or other countries. ON Semiconductor owns the rights to a number of patents, trademarks, copyrights, trade secrets, and other intellectual property. A listing of ON Semiconductor's product/patent coverage may be accessed at [www.onsemi.com/site/pdf/Patent-Marking.pdf](http://www.onsemi.com/site/pdf/Patent-Marking.pdf). ON Semiconductor reserves the right to make changes without further notice to any products herein. ON Semiconductor makes no warranty, representation or guarantee regarding the suitability of its products for any particular purpose, nor does ON Semiconductor assume any liability arising out of the application or use of any product or circuit, and specifically disclaims any and all liability, including without limitation special, consequential or incidental damages. Buyer is responsible for its products and applications using ON Semiconductor products, including compliance with all laws, regulations and safety requirements or standards, regardless of any support or applications information provided by ON Semiconductor. "Typical" parameters which may be provided in ON Semiconductor data sheets and/or specifications can and do vary in different applications and actual performance may vary over time. All operating parameters, including "Typicals" must be validated for each customer application by customer's technical experts. ON Semiconductor does not convey any license under its patent rights nor the rights of others. ON Semiconductor products are not designed, intended, or authorized for use as a critical component in life support systems or any FDA Class 3 medical devices or medical devices with a same or similar classification in a foreign jurisdiction or any devices intended for implantation in the human body. Should Buyer purchase or use ON Semiconductor products for any such unintended or unauthorized application, Buyer shall indemnify and hold ON Semiconductor and its officers, employees, subsidiaries, affiliates, and distributors harmless against all claims, costs, damages, and expenses, and reasonable attorney fees arising out of, directly or indirectly, any claim of personal injury or death associated with such unintended or unauthorized use, even if such claim alleges that ON Semiconductor was negligent regarding the design or manufacture of the part. ON Semiconductor is an Equal Opportunity/Affirmative Action Employer. This literature is subject to all applicable copyright laws and is not for resale in any manner.

# MCT2M, MCT2EM, MCT210M, MCT271M Phototransistor Optocouplers

## Features

- UL recognized (File # E90700, Vol. 2)
- IEC60747-5-2 recognized (File # 102497)
  - Add option V (e.g., MCT2VM)

## Applications

- Power supply regulators
- Digital logic inputs
- Microprocessor inputs

## Description

The MCT2XXM series optoisolators consist of a gallium arsenide infrared emitting diode driving a silicon phototransistor in a 6-pin dual in-line package.

## Schematic

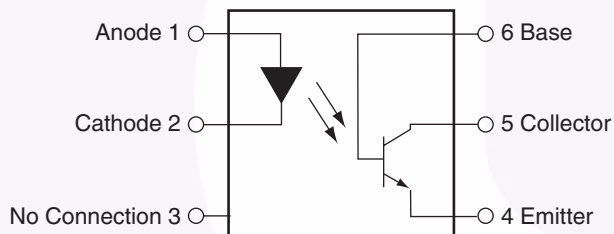

## Package Outlines

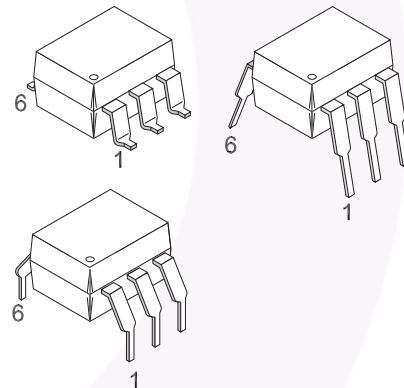

## Absolute Maximum Ratings

Stresses exceeding the absolute maximum ratings may damage the device. The device may not function or be operable above the recommended operating conditions and stressing the parts to these levels is not recommended. In addition, extended exposure to stresses above the recommended operating conditions may affect device reliability. The absolute maximum ratings are stress ratings only.

Symbol	Parameter	Value	Units
<b>TOTAL DEVICE</b>			
$T_{STG}$	Storage Temperature	-40 to +150	°C
$T_{OPR}$	Operating Temperature	-40 to +100	°C
$T_{SOL}$	Lead Solder Temperature	260 for 10 sec	°C
$P_D$	Total Device Power Dissipation @ $T_A = 25^\circ\text{C}$ Derate above $25^\circ\text{C}$	250	mW
		2.94	mW/°C
<b>EMITTER</b>			
$I_F$	DC/Average Forward Input Current	60	mA
$V_R$	Reverse Input Voltage	3	V
$I_F(\text{pk})$	Forward Current – Peak (300 $\mu\text{s}$ , 2% Duty Cycle)	3	A
$P_D$	LED Power Dissipation @ $T_A = 25^\circ\text{C}$ Derate above $25^\circ\text{C}$	120	mW
		1.41	mW/°C
<b>DETECTOR</b>			
$I_C$	Collector Current	50	mA
$V_{CEO}$	Collector-Emitter Voltage	30	V
$P_D$	Detector Power Dissipation @ $T_A = 25^\circ\text{C}$ Derate above $25^\circ\text{C}$	150	mW
		1.76	mW/°C

**Electrical Characteristics** ( $T_A = 25^\circ\text{C}$  unless otherwise specified)**Individual Component Characteristics**

Symbol	Parameter	Test Conditions	Device	Min.	Typ.*	Max.	Units
<b>EMITTER</b>							
$V_F$	Input Forward Voltage	$I_F = 20\text{mA}$	MCT2M MCT2EM MCT271M		1.25	1.50	V
		$T_A = 0^\circ\text{C} - 70^\circ\text{C}$ , $I_F = 40\text{mA}$	MCT210M		1.33		
$I_R$	Reverse Leakage Current	$V_R = 3.0\text{V}$	MCT2M MCT2EM MCT271M		0.001	10	$\mu\text{A}$
		$T_A = 0^\circ\text{C} - 70^\circ\text{C}$ , $V_R = 6.0\text{V}$	MCT210M				
<b>DETECTOR</b>							
$BV_{CEO}$	Collector-Emitter Breakdown Voltage	$I_C = 1.0\text{mA}$ , $I_F = 0$	ALL	30	100		V
		$T_A = 0^\circ\text{C} - 70^\circ\text{C}$	MCT210M				
$BV_{CBO}$	Collector-Base Breakdown Voltage	$I_C = 10\mu\text{A}$ , $I_F = 0$	MCT2M MCT2EM MCT271M	70	120		V
		$T_A = 0^\circ\text{C} - 70^\circ\text{C}$	MCT210M	30			
$BV_{ECO}$	Emitter-Collector Breakdown Voltage	$I_E = 100\mu\text{A}$ , $I_F = 0$	MCT2M MCT2EM MCT271M	7	10		V
		$T_A = 0^\circ\text{C} - 70^\circ\text{C}$	MCT210M	6	10		
$I_{CEO}$	Collector-Emitter Dark Current	$V_{CE} = 10\text{V}$ , $I_F = 0$	ALL		1	50	nA
		$V_{CE} = 5\text{V}$ , $T_A = 0^\circ\text{C} - 70^\circ\text{C}$				30	$\mu\text{A}$
$I_{CBO}$	Collector-Base Dark Current	$V_{CB} = 10\text{V}$ , $I_F = 0$	ALL			20	nA
$C_{CE}$	Capacitance	$V_{CE} = 0\text{V}$ , $f = 1\text{MHz}$	ALL		8		pF

\*All typical  $T_A = 25^\circ\text{C}$ **Isolation Characteristics**

Symbol	Parameter	Test Conditions	Min	Typ*	Max	Units
$V_{ISO}$	Input-Output Isolation Voltage	$f = 60\text{Hz}$ , $t = 1 \text{ sec.}$	7500			Vac(pk)
$R_{ISO}$	Isolation Resistance	$V_{I-O} = 500 \text{ VDC}$	$10^{11}$			$\Omega$
$C_{ISO}$	Isolation Capacitance			0.2	2	pF

\*All typicals at  $T_A = 25^\circ\text{C}$

**Electrical Characteristics** (Continued) ( $T_A = 25^\circ\text{C}$  unless otherwise specified)**Transfer Characteristics**

Symbol	Parameter	Test Conditions	Device	Min.	Typ.*	Max.	Unit
<b>DC CHARACTERISTICS</b>							
CTR	Output Collector Current	$T_A = 0^\circ\text{C} - 70^\circ\text{C}$	MCT210M	150			%
		$I_F = 10\text{mA}, V_{CE} = 10\text{V}$	MCT2M MCT2EM	20			
			MCT271M	45		90	
		$I_F = 3.2\text{mA to } 32\text{mA}, V_{CE} = 0.4\text{V}, T_A = 0^\circ\text{C} - 70^\circ\text{C}$	MCT210M	50			
$V_{CE(\text{SAT})}$	Collector-Emitter Saturation Voltage	$I_C = 2\text{mA}, I_F = 16\text{mA}$	MCT2M MCT2EM MCT271M			0.4	V
		$I_C = 16\text{mA}, I_F = 32\text{mA}, T_A = 0^\circ\text{C} - 70^\circ\text{C}$	MCT210M				
<b>AC CHARACTERISTICS</b>							
$t_{\text{on}}$	AC Characteristic Saturated Turn-on Time from 5V to 0.8V	$I_F = 15\text{mA}, V_{CC} = 5\text{V}, R_L = 2\text{k}\Omega, R_B = \text{Open (Fig. 11)}$	MCT2M MCT2EM		1.1		$\mu\text{s}$
		$I_F = 20\text{mA}, V_{CC} = 5\text{V}, R_L = 2\text{k}\Omega, R_B = 100\text{k}\Omega \text{ (Fig. 11)}$	MCT2M MCT2EM		1.3		
$t_{\text{off}}$	Saturated Turn-off Time from SAT to 2.0 V	$I_F = 15\text{mA}, V_{CC} = 5\text{V}, R_L = 2\text{k}\Omega, R_B = \text{Open (Fig. 11)}$	MCT2M MCT2EM		50		$\mu\text{s}$
		$I_F = 20\text{mA}, V_{CC} = 5\text{V}, R_L = 2\text{k}\Omega, R_B = 100\text{k}\Omega \text{ (Fig. 11)}$	MCT2M MCT2EM		20		
$t_{\text{on}}$	Turn-on Time	$I_F = 10\text{mA}, V_{CC} = 10\text{V}, R_L = 100\Omega$	MCT2M MCT2EM		2		$\mu\text{s}$
$t_{\text{off}}$	Turn-off Time	$I_F = 10\text{mA}, V_{CC} = 10\text{V}, R_L = 100\Omega$	MCT2M MCT2EM		2		$\mu\text{s}$
$t_r$	Rise Time	$I_F = 10\text{mA}, V_{CC} = 10\text{V}, R_L = 100\Omega$	MCT2M MCT2EM		2		$\mu\text{s}$
$t_f$	Fall Time	$I_F = 10\text{mA}, V_{CC} = 10\text{V}, R_L = 100\Omega$	MCT2M MCT2EM		1.5		$\mu\text{s}$
$t_{\text{on}}$	Saturated turn-on time	$I_F = 16\text{mA}, R_L = 1.9\text{k}\Omega, V_{CC} = 5\text{V (Fig. 11)}$	MCT271M		1.0		$\mu\text{s}$
$t_{\text{off}}$	Saturated turn-off time (Approximates a typical TTL interface)				48		$\mu\text{s}$
$t_{\text{on}}$	Saturated turn-on time	$I_F = 16\text{mA}, R_L = 4.7\text{k}\Omega, V_{CC} = 5\text{V (Fig. 20)}$	MCT271M		1.0		$\mu\text{s}$
$t_{\text{off}}$	Saturated turn-off time (Approximates a typical low power TTL interface)				98		$\mu\text{s}$
$t_r$	Saturated rise time	$I_F = 16\text{mA}, R_L = 560\Omega, V_{CC} = 5\text{V (Fig. 11, 12)}$	MCT210M		1.0		$\mu\text{s}$
$t_f$	Saturated fall time				11		$\mu\text{s}$
$T_{PD}(\text{HL})$	Saturated propagation delay – HIGH to LOW	$I_F = 16\text{mA}, R_L = 2.7\text{k}\Omega \text{ (Fig. 11, 12)}$	MCT210M		1.0		$\mu\text{s}$
$T_{PD}(\text{LH})$	Saturated propagation delay – LOW to HIGH				50		$\mu\text{s}$
$t_r$	Non-saturated rise time	$I_C = 2\text{mA}, V_{CC} = 5\text{V}, R_L = 100\Omega \text{ (Fig. 11)}$	MCT210M		2		$\mu\text{s}$
$t_f$	Non-saturated fall time				2		$\mu\text{s}$
$t_{\text{on}}$	Non-saturated turn-on time	$I_C = 2\text{mA}, V_{CC} = 5\text{V}, R_L = 100\Omega \text{ (Fig. 20)}$	MCT271M		2	7	$\mu\text{s}$
$t_{\text{off}}$	Non-saturated turn-off time				2	7	$\mu\text{s}$

\*All typicals at  $T_A = 25^\circ\text{C}$

## Safety and Insulation Ratings

As per IEC 60747-5-2, this optocoupler is suitable for “safe electrical insulation” only within the safety limit data. Compliance with the safety ratings shall be ensured by means of protective circuits.

Symbol	Parameter	Min.	Typ.	Max.	Unit
	Installation Classifications per DIN VDE 0110/1.89 Table 1				
	For Rated Main Voltage < 150Vrms		I-IV		
	For Rated Main voltage < 300Vrms		I-IV		
	Climatic Classification		55/100/21		
	Pollution Degree (DIN VDE 0110/1.89)		2		
CTI	Comparative Tracking Index	175			
$V_{PR}$	Input to Output Test Voltage, Method b, $V_{IORM} \times 1.875 = V_{PR}$ , 100% Production Test with $t_m = 1$ sec, Partial Discharge < 5pC	1594			$V_{peak}$
	Input to Output Test Voltage, Method a, $V_{IORM} \times 1.5 = V_{PR}$ , Type and Sample Test with $t_m = 60$ sec, Partial Discharge < 5pC	1275			$V_{peak}$
$V_{IORM}$	Max. Working Insulation Voltage	850			$V_{peak}$
$V_{IOTM}$	Highest Allowable Over Voltage	6000			$V_{peak}$
	External Creepage	7			mm
	External Clearance	7			mm
	Insulation Thickness	0.5			mm
RIO	Insulation Resistance at $T_s$ , $V_{IO} = 500V$	$10^9$			$\Omega$

## Typical Performance Curves

Fig. 1 LED Forward Voltage vs. Forward Current

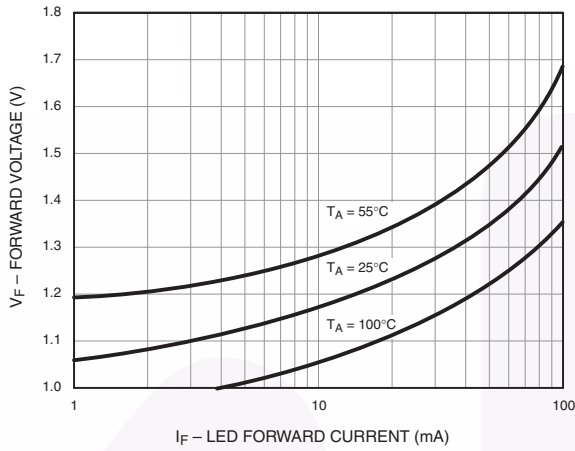

Fig. 2 Normalized CTR vs. Forward Current

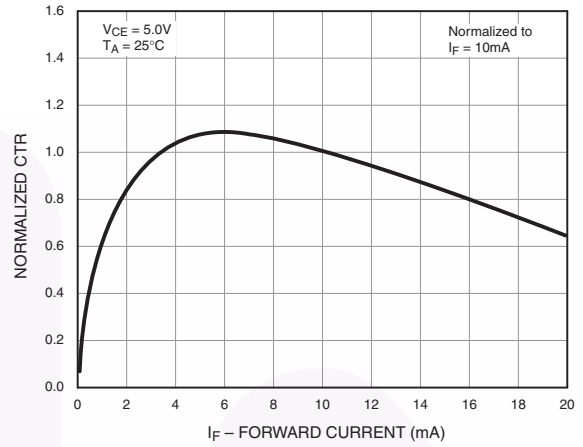

Fig. 3 Normalized CTR vs. Ambient Temperature

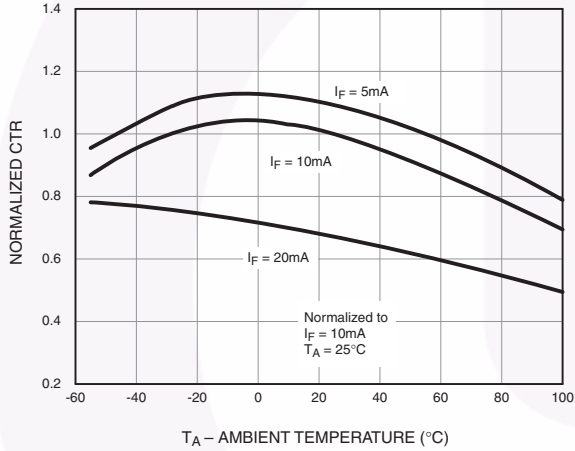

Fig. 4 CTR vs. RBE (Unsaturated)

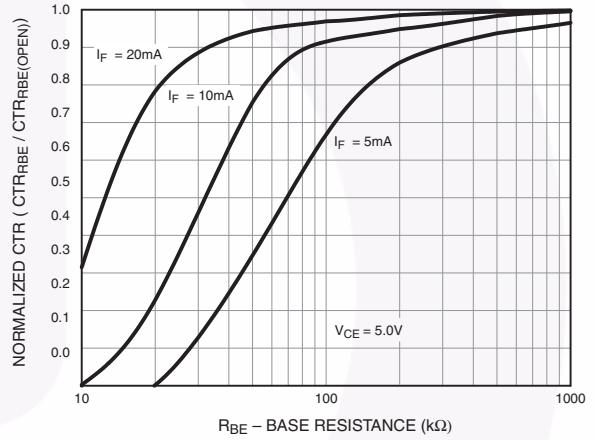

Fig. 5 CTR vs. RBE (Saturated)

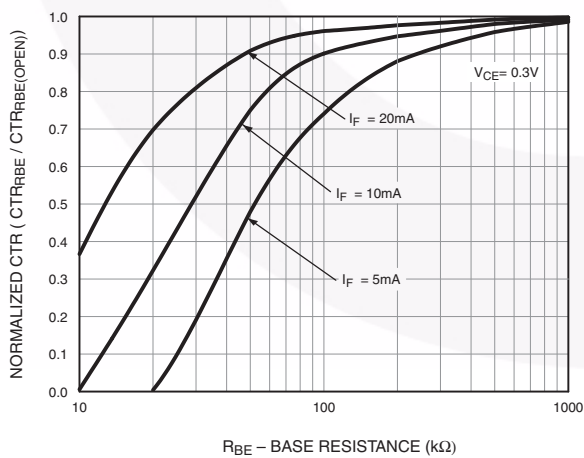
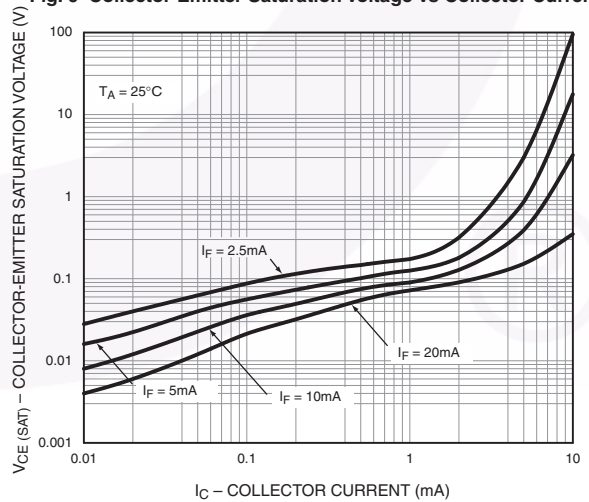

Fig. 6 Collector-Emitter Saturation Voltage vs Collector Current



Typical Performance Curves (Continued)

Fig. 7 Switching Speed vs. Load Resistor

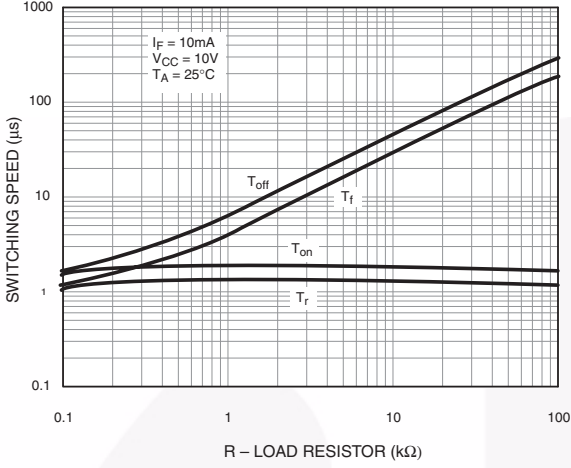

Fig. 8 Normalized  $t_{on}$  vs.  $R_{BE}$

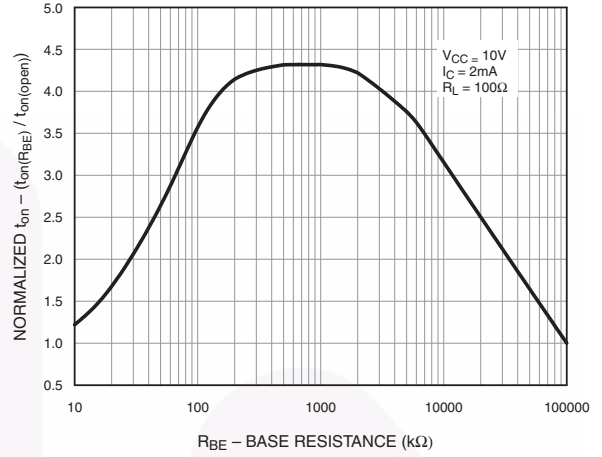

Fig. 9 Normalized  $t_{off}$  vs.  $R_{BE}$

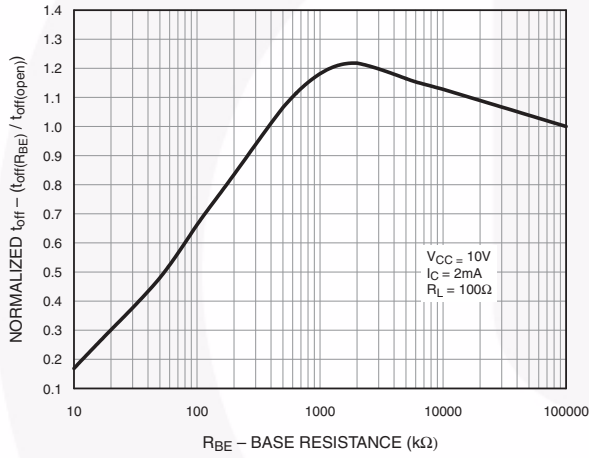
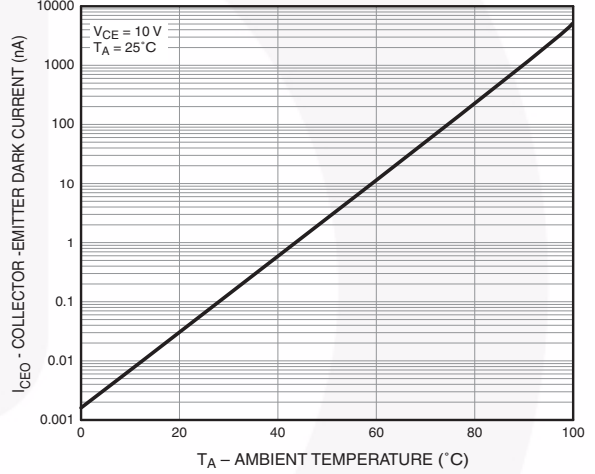

Fig. 10 Dark Current vs. Ambient Temperature





## Typical Electro-Optical Characteristics

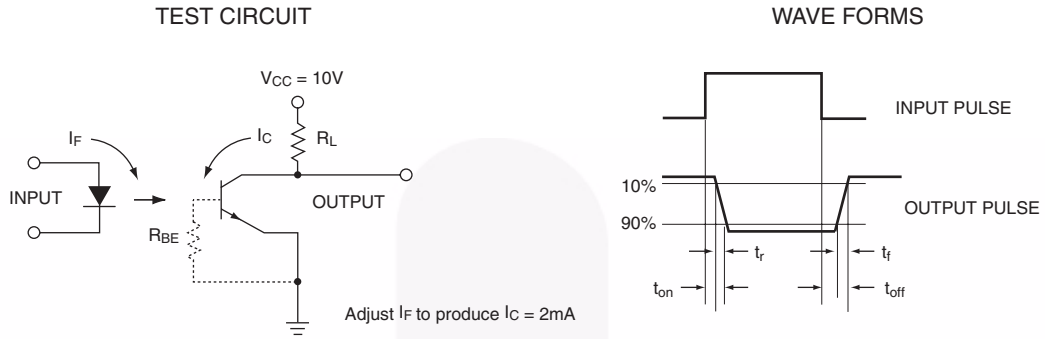

Figure 11. Switching Time Test Circuit and Waveforms

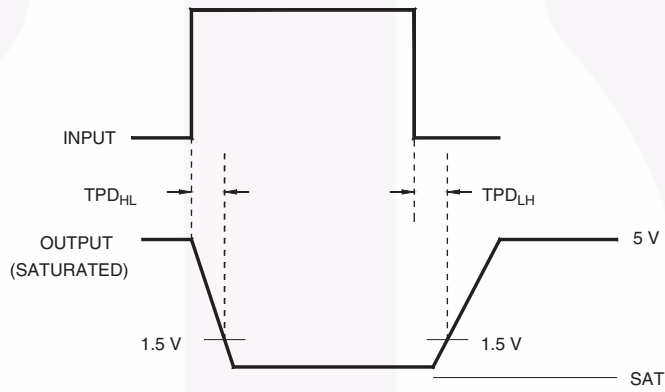
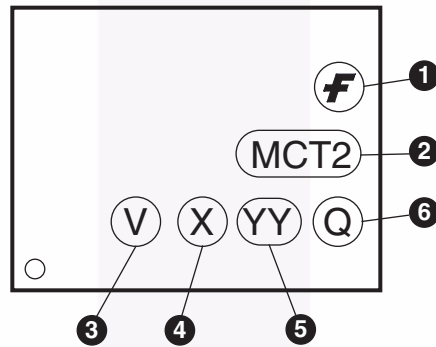

Figure 12. Switching Time Waveforms (MCT210M)

### Ordering Information

Option	Order Entry Identifier (Example)	Description
No suffix	MCT2M	Standard Through Hole Device (50 units per tube)
S	MCT2SM	Surface Mount Lead Bend
SR2	MCT2SR2M	Surface Mount; Tape and Reel (1,000 units per reel)
T	MCT2TM	0.4" Lead Spacing
V	MCT2VM	IEC60747-5-2
TV	MCT2TVM	IEC60747-5-2, 0.4" Lead Spacing
SV	MCT2SVM	IEC60747-5-2, Surface Mount
SR2V	MCT2SR2VM	IEC60747-5-2, Surface Mount, Tape and Reel (1,000 units per reel)

### Marking Information



Definitions	
1	Fairchild logo
2	Device number
3	VDE mark (Note: Only appears on parts ordered with VDE option – See order entry table)
4	One digit year code, e.g., '7'
5	Two digit work week ranging from '01' to '53'
6	Assembly package code

\*Note – Parts that do not have the 'V' option (see definition 3 above) that are marked with date code '325' or earlier are marked in portrait format.

### Carrier Tape Specification

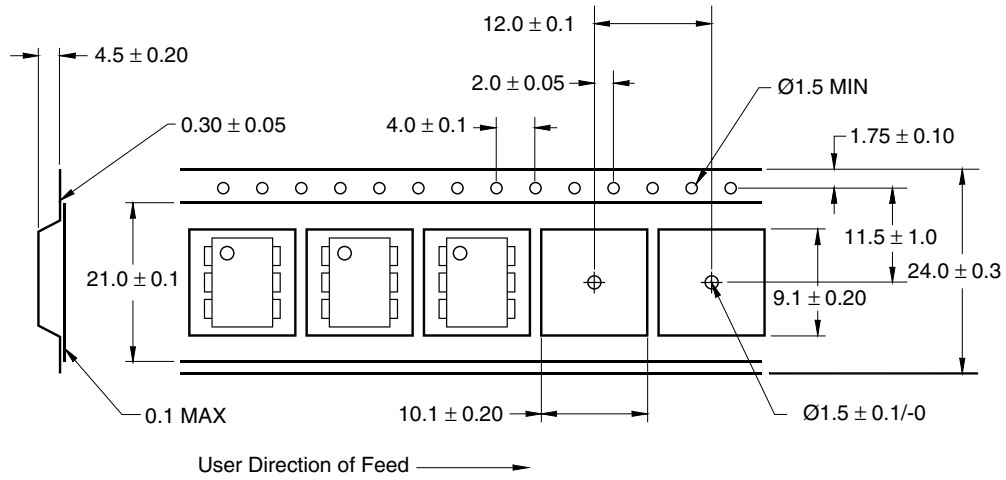

### Reflow Profile

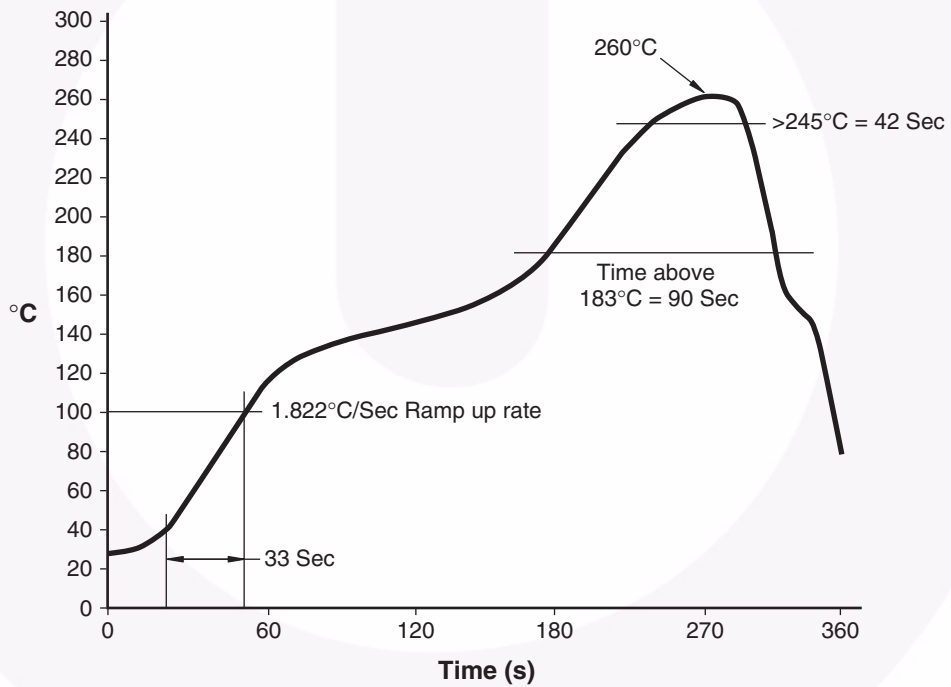



- NOTES:
- A) NO STANDARD APPLIES TO THIS PACKAGE.
  - B) ALL DIMENSIONS ARE IN MILLIMETERS.
  - C) DIMENSIONS ARE EXCLUSIVE OF BURRS, MOLD FLASH, AND TIE BAR EXTRUSION
  - D) DRAWING FILENAME AND REVISION: MKT-N06BREV4.





LAND PATTERN RECOMMENDATION



NOTES:

- A) NO STANDARD APPLIES TO THIS PACKAGE.
- B) ALL DIMENSIONS ARE IN MILLIMETERS.
- C) DIMENSIONS ARE EXCLUSIVE OF BURRS, MOLD FLASH, AND TIE BAR EXTRUSION
- D) DRAWING FILENAME AND REVISION : MKT-N06CREV4.



ON Semiconductor and  are trademarks of Semiconductor Components Industries, LLC dba ON Semiconductor or its subsidiaries in the United States and/or other countries. ON Semiconductor owns the rights to a number of patents, trademarks, copyrights, trade secrets, and other intellectual property. A listing of ON Semiconductor's product/patent coverage may be accessed at [www.onsemi.com/site/pdf/Patent-Marking.pdf](http://www.onsemi.com/site/pdf/Patent-Marking.pdf). ON Semiconductor reserves the right to make changes without further notice to any products herein. ON Semiconductor makes no warranty, representation or guarantee regarding the suitability of its products for any particular purpose, nor does ON Semiconductor assume any liability arising out of the application or use of any product or circuit, and specifically disclaims any and all liability, including without limitation special, consequential or incidental damages. Buyer is responsible for its products and applications using ON Semiconductor products, including compliance with all laws, regulations and safety requirements or standards, regardless of any support or applications information provided by ON Semiconductor. "Typical" parameters which may be provided in ON Semiconductor data sheets and/or specifications can and do vary in different applications and actual performance may vary over time. All operating parameters, including "Typicals" must be validated for each customer application by customer's technical experts. ON Semiconductor does not convey any license under its patent rights nor the rights of others. ON Semiconductor products are not designed, intended, or authorized for use as a critical component in life support systems or any FDA Class 3 medical devices or medical devices with a same or similar classification in a foreign jurisdiction or any devices intended for implantation in the human body. Should Buyer purchase or use ON Semiconductor products for any such unintended or unauthorized application, Buyer shall indemnify and hold ON Semiconductor and its officers, employees, subsidiaries, affiliates, and distributors harmless against all claims, costs, damages, and expenses, and reasonable attorney fees arising out of, directly or indirectly, any claim of personal injury or death associated with such unintended or unauthorized use, even if such claim alleges that ON Semiconductor was negligent regarding the design or manufacture of the part. ON Semiconductor is an Equal Opportunity/Affirmative Action Employer. This literature is subject to all applicable copyright laws and is not for resale in any manner.

## PUBLICATION ORDERING INFORMATION

### LITERATURE FULFILLMENT:

Literature Distribution Center for ON Semiconductor  
19521 E. 32nd Pkwy, Aurora, Colorado 80011 USA  
**Phone:** 303-675-2175 or 800-344-3860 Toll Free USA/Canada  
**Fax:** 303-675-2176 or 800-344-3867 Toll Free USA/Canada  
**Email:** [orderlit@onsemi.com](mailto:orderlit@onsemi.com)

**N. American Technical Support:** 800-282-9855 Toll Free  
USA/Canada  
**Europe, Middle East and Africa Technical Support:**  
Phone: 421 33 790 2910  
**Japan Customer Focus Center**  
Phone: 81-3-5817-1050

**ON Semiconductor Website:** [www.onsemi.com](http://www.onsemi.com)  
**Order Literature:** <http://www.onsemi.com/orderlit>  
For additional information, please contact your local  
Sales Representative