



Is Now Part of



**ON Semiconductor®**

To learn more about ON Semiconductor, please visit our website at

[www.onsemi.com](http://www.onsemi.com)

ON Semiconductor and the ON Semiconductor logo are trademarks of Semiconductor Components Industries, LLC dba ON Semiconductor or its subsidiaries in the United States and/or other countries. ON Semiconductor owns the rights to a number of patents, trademarks, copyrights, trade secrets, and other intellectual property. A listing of ON Semiconductor's product/patent coverage may be accessed at [www.onsemi.com/site/pdf/Patent-Marking.pdf](http://www.onsemi.com/site/pdf/Patent-Marking.pdf). ON Semiconductor reserves the right to make changes without further notice to any products herein. ON Semiconductor makes no warranty, representation or guarantee regarding the suitability of its products for any particular purpose, nor does ON Semiconductor assume any liability arising out of the application or use of any product or circuit, and specifically disclaims any and all liability, including without limitation special, consequential or incidental damages. Buyer is responsible for its products and applications using ON Semiconductor products, including compliance with all laws, regulations and safety requirements or standards, regardless of any support or applications information provided by ON Semiconductor. "Typical" parameters which may be provided in ON Semiconductor data sheets and/or specifications can and do vary in different applications and actual performance may vary over time. All operating parameters, including "Typicals" must be validated for each customer application by customer's technical experts. ON Semiconductor does not convey any license under its patent rights nor the rights of others. ON Semiconductor products are not designed, intended, or authorized for use as a critical component in life support systems or any FDA Class 3 medical devices or medical devices with a same or similar classification in a foreign jurisdiction or any devices intended for implantation in the human body. Should Buyer purchase or use ON Semiconductor products for any such unintended or unauthorized application, Buyer shall indemnify and hold ON Semiconductor and its officers, employees, subsidiaries, affiliates, and distributors harmless against all claims, costs, damages, and expenses, and reasonable attorney fees arising out of, directly or indirectly, any claim of personal injury or death associated with such unintended or unauthorized use, even if such claim alleges that ON Semiconductor was negligent regarding the design or manufacture of the part. ON Semiconductor is an Equal Opportunity/Affirmative Action Employer. This literature is subject to all applicable copyright laws and is not for resale in any manner.



March 2015

# KA431S / KA431SA / KA431SL Programmable Shunt Regulator

## Features

- Programmable Output Voltage to 36 V
- Low Dynamic Output Impedance 0.2  $\Omega$  (Typical)
- Sink Current Capability: 1.0 to 100 mA
- Equivalent Full-Range Temperature Coefficient of 50 ppm/ $^{\circ}\text{C}$  (Typical)
- Temperature Compensated for Operation Over Full Rated Operating Temperature Range
- Low Output Noise Voltage
- Fast Turn-on Response

## Description

The KA431S / KA431SA / KA431SL are three-terminal adjustable regulator series with a guaranteed thermal stability over the operating temperature range. The output voltage can be set to any value between  $V_{REF}$  (approximately 2.5 V) and 36 V with two external resistors. These devices have a typical dynamic output impedance of 0.2  $\Omega$ . Active output circuitry provides a sharp turn-on characteristic, making these devices excellent replacement for zener diodes in many applications.

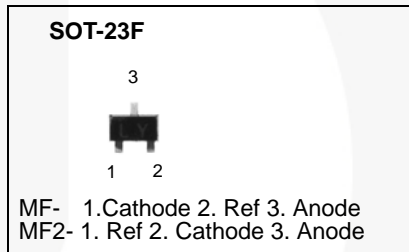

## Ordering Information

Part Number	Operating Temperature Range	Output Voltage Tolerance	Top Mark	Package	Packing Method
KA431SMFTF	-25 to +85 $^{\circ}\text{C}$	2%	43A	SOT-23F 3L	Tape and Reel
KA431SMF2TF			43D		
KA431SAMFTF		1%	43B		
KA431SAMF2TF			43E		
KA431SLMFTF		0.5%	43C		
KA431SLMF2TF			43F		

KA431S / KA431SA / KA431SL — Programmable Shunt Regulator

**Block Diagram**

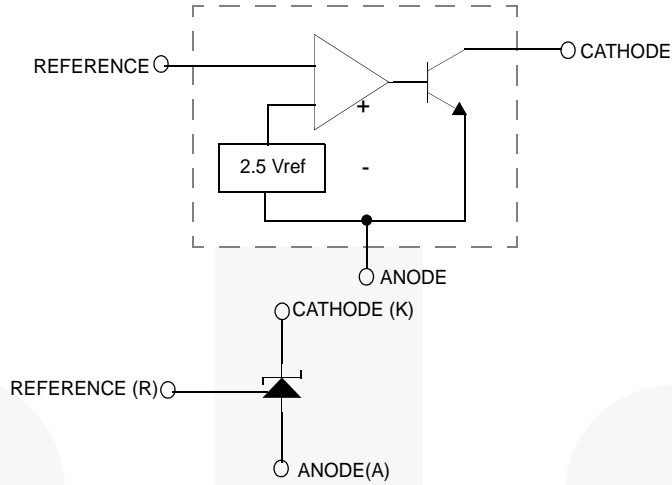

**Figure 1. Block Diagram**

**Marking Information**

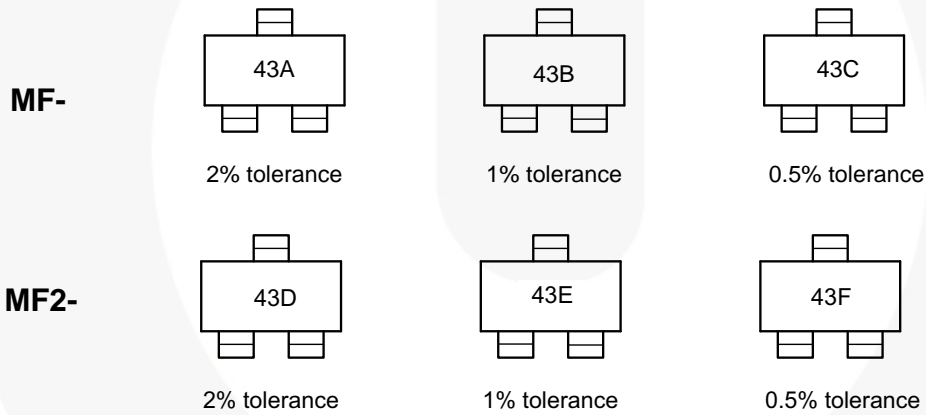

**Figure 2. Top Mark (per package)**



## Absolute Maximum Ratings

Stresses exceeding the absolute maximum ratings may damage the device. The device may not function or be operable above the recommended operating conditions and stressing the parts to these levels is not recommended. In addition, extended exposure to stresses above the recommended operating conditions may affect device reliability. The absolute maximum ratings are stress ratings only. Values are at  $T_A = 25^\circ\text{C}$  unless otherwise noted.

Symbol	Parameter	Value	Unit
$V_{KA}$	Cathode Voltage	37	V
$I_{KA}$	Cathode Current Range (Continuous)	-100 ~ +150	mA
$I_{REF}$	Reference Input Current Range	-0.05 ~ +10	mA
$R_{\theta JA}$	Thermal Resistance Junction-Air <sup>(1,2)</sup> MF Suffix Package	350	$^\circ\text{C}/\text{W}$
$P_D$	Power Dissipation <sup>(3,4)</sup> MF Suffix Package	350	mW
$T_J$	Junction Temperature	150	$^\circ\text{C}$
$T_{OPR}$	Operating Temperature Range	-25 ~ +85	$^\circ\text{C}$
$T_{STG}$	Storage Temperature Range	-65 ~ +150	$^\circ\text{C}$

### Notes:

- Thermal resistance test board  
Size: 1.6mm x 76.2mm x 114.3mm (1S0P)  
JEDEC Standard: JESD51-3, JESD51-7.
- Assume no ambient airflow.
- $T_{JMAX} = 150^\circ\text{C}$ ; Ratings apply to ambient temperature at  $25^\circ\text{C}$ .
- Power dissipation calculation:  $P_D = (T_J - T_A) / R_{\theta JA}$ .

## Recommended Operating Conditions

The Recommended Operating Conditions table defines the conditions for actual device operation. Recommended operating conditions are specified to ensure optimal performance to the datasheet specifications. Fairchild does not recommend exceeding them or designing to Absolute Maximum Ratings.

Symbol	Parameter	Min.	Max.	Unit
$V_{KA}$	Cathode Voltage	$V_{REF}$	36	V
$I_{KA}$	Cathode Current	1	100	mA

**Electrical Characteristics<sup>(5)</sup>**Values are at  $T_A = 25^\circ\text{C}$  unless otherwise noted.

Symbol	Parameter	Conditions	KA431S			KA431SA			KA431SL			Unit	
			Min.	Typ.	Max.	Min.	Typ.	Max.	Min.	Typ.	Max.		
$V_{REF}$	Reference Input Voltage	$V_{KA} = V_{REF}$ , $I_{KA} = 10\text{ mA}$	2.450	2.500	2.550	2.470	2.495	2.520	2.482	2.495	2.508	V	
$\Delta V_{REF}/\Delta T$	Deviation of Reference Input Voltage Over-Temperature	$V_{KA} = V_{REF}$ , $I_{KA} = 10\text{ mA}$ , $T_{MIN} \leq T_A \leq T_{MAX}$		4.5	17.0		4.5	17.0		4.5	17.0	mV	
$\Delta V_{REF}/\Delta V_{KA}$	Ratio of Change in Reference Input Voltage to the Change in Cathode Voltage	$I_{KA} = 10\text{ mA}$	$\Delta V_{KA} = 10\text{ V} - V_{REF}$		-1.0	-2.7		-1.0	-2.7		-1.0	-2.7	mV/V
			$\Delta V_{KA} = 36\text{ V} - 10\text{ V}$		-0.5	-2.0		-0.5	-2.0		-0.5	-2.0	
$I_{REF}$	Reference Input Current	$I_{KA} = 10\text{ mA}$ , $R1 = 10\text{ k}\Omega$ , $R2 = \infty$		1.5	4.0		1.5	4.0		1.5	4.0	$\mu\text{A}$	
$\Delta I_{REF}/\Delta T$	Deviation of Reference Input Current Over Full Temperature Range	$I_{KA} = 10\text{ mA}$ , $R1 = 10\text{ k}\Omega$ , $R2 = \infty$ , $T_A = \text{Full Range}$		0.4	1.2		0.4	1.2		0.4	1.2	$\mu\text{A}$	
$I_{KA(MIN)}$	Minimum Cathode Current for Regulation	$V_{KA} = V_{REF}$		0.45	1.00		0.45	1.00		0.45	1.00	mA	
$I_{KA(OFF)}$	Off - Stage Cathode Current	$V_{KA} = 36\text{ V}$ , $V_{REF} = 0$		0.05	1.00		0.05	1.00		0.05	1.00	$\mu\text{A}$	
$Z_{KA}$	Dynamic Impedance	$V_{KA} = V_{REF}$ , $I_{KA} = 1\text{ to }100\text{ mA}$ , $f \geq 1.0\text{ kHz}$		0.15	0.50		0.15	0.50		0.15	0.50	$\Omega$	

**Note:**5.  $T_{MIN} = -25^\circ\text{C}$ ,  $T_{MAX} = +85^\circ\text{C}$

## Test Circuits

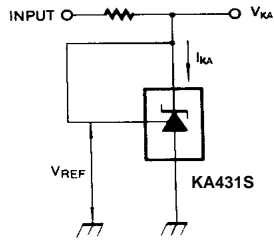

Figure 3. Test Circuit for  $V_{KA} = V_{REF}$

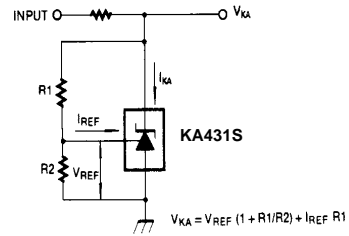

Figure 4. Test Circuit for  $V_{KA} \geq V_{REF}$

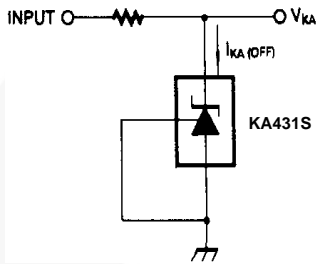

Figure 5. Test Circuit for  $I_{KA(OFF)}$

## Typical Applications

$$V_O = \left(1 + \frac{R_1}{R_2}\right) V_{ref}$$

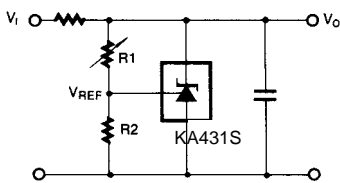

Figure 6. Shunt Regulator

$$V_O = V_{ref} \left(1 + \frac{R_1}{R_2}\right)$$

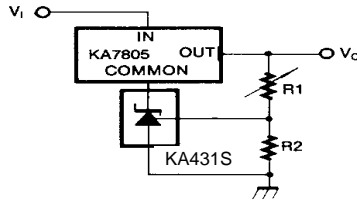

Figure 7. Output Control for Three-Terminal Fixed Regulator

$$V_O = \left(1 + \frac{R_1}{R_2}\right) V_{ref}$$

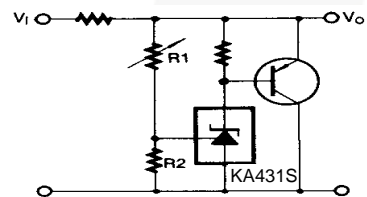

Figure 8. High Current Shunt Regulator

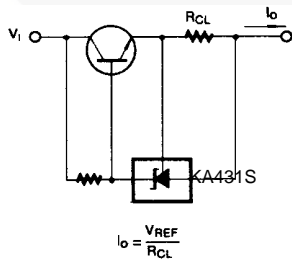

Figure 9. Current Limit or Current Source

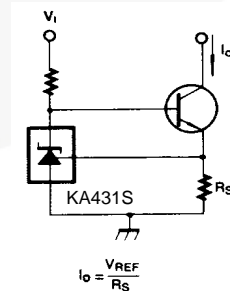

Figure 10. Constant-Current Sink

## Typical Performance Characteristics

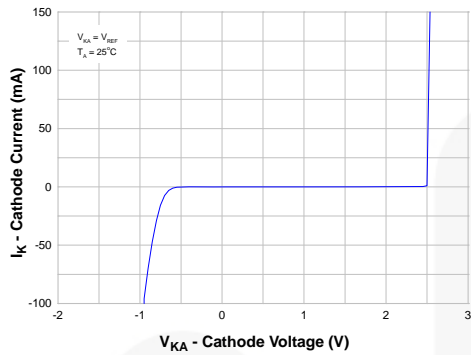

Figure 11. Cathode Current vs. Cathode Voltage

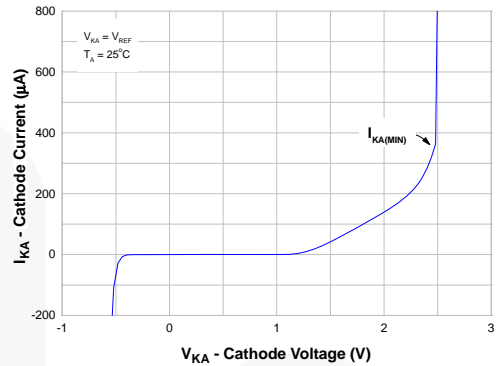

Figure 12. Cathode Current vs. Cathode Voltage

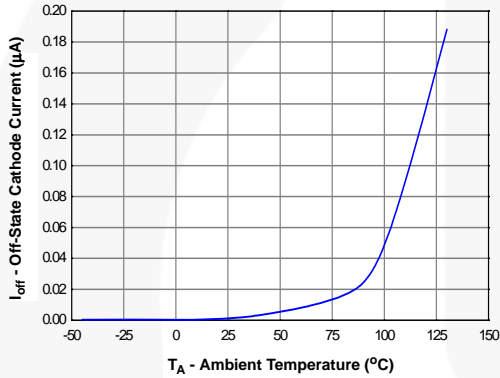

Figure 13. OFF-State Cathode Current vs. Ambient Temperature

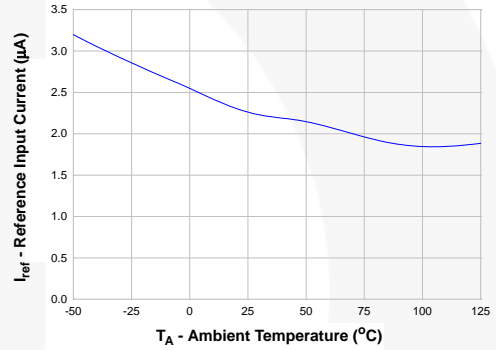

Figure 14. Reference Input Current vs. Ambient Temperature

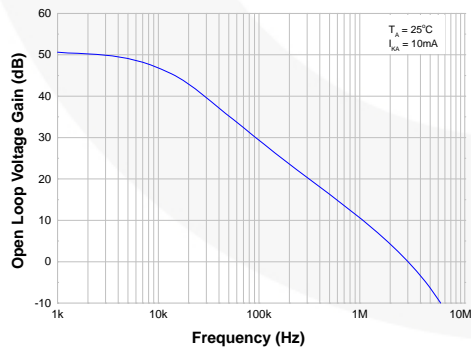

Figure 15. Frequency vs. Small Signal Voltage Amplification

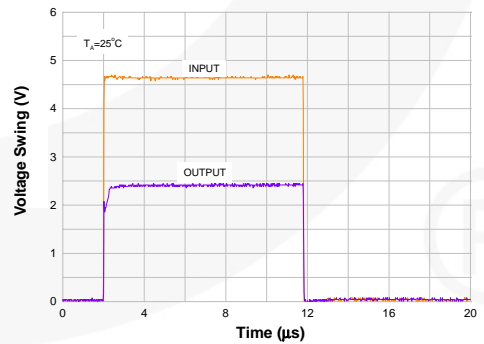

Figure 16. Pulse Response

Typical Performance Characteristics (Continued)

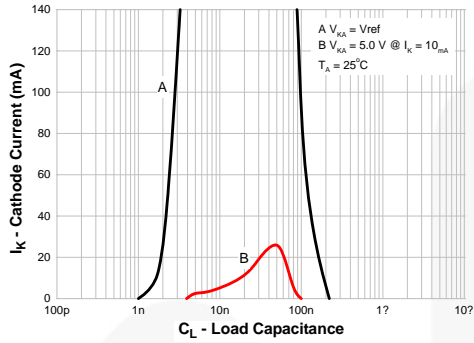

Figure 17. Stability Boundary Conditions

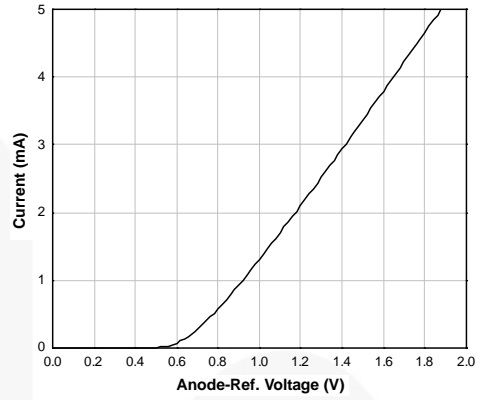

Figure 18. Anode-Reference Diode Curve

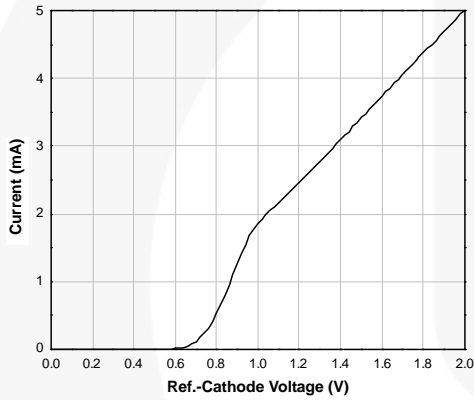

Figure 19. Reference-Cathode Diode Curve

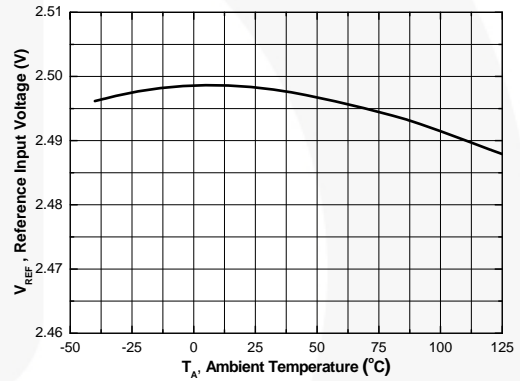
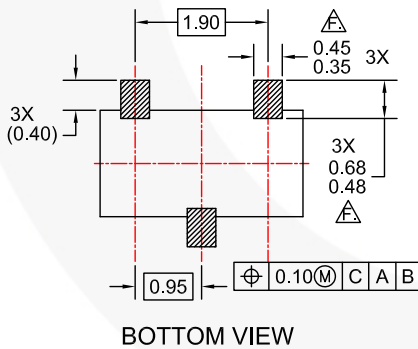
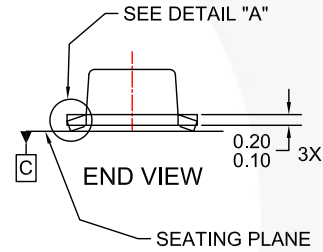
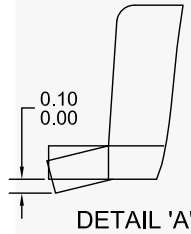
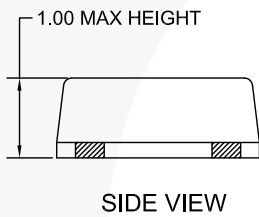
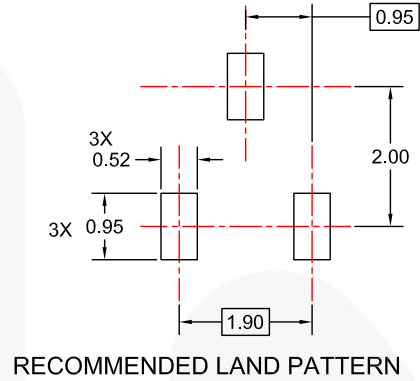
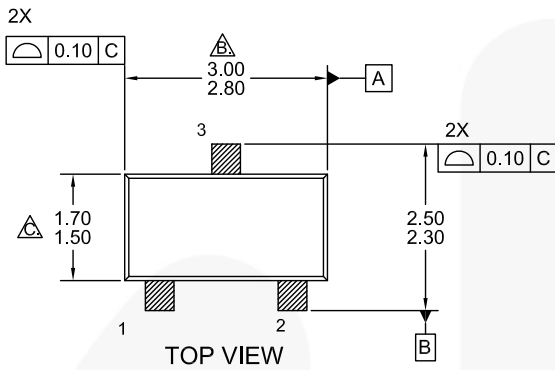

Figure 20. Reference Input Voltage vs. Ambient Temperature



Physical Dimensions



NOTES:





- A. ALL DIMENSIONS ARE IN MILLIMETERS.
- B. DIMENSION DOES NOT INCLUDE MOLD FLASH, PROTRUSIONS OR GATE BURRS. MOLD FLASH, PROTRUSIONS OR GATE BURRS SHALL NOT EXCEED 0.15mm PER END.
- C. DIMENSION DOES NOT INCLUDE INTERLEAD FLASH OR PROTRUSION. INTERLEAD FLASH OR PROTRUSION SHALL NOT EXCEED 0.15mm PER SIDE.
- D. DIMENSIONS B AND C ARE DETERMINED AT THE OUTMOST EXTREMES OF THE PLASTIC BODY EXCLUSIVE OF MOLD FLASH, TIE BAR BURRS, GATE BURRS AND INTERLEAD FLASH. BUT INCLUDING ANY MISMATCH BETWEEN THE TOP AND BOTTOM OF THE PLASTIC BODY.
- E. TERMINAL NUMBERS ARE SHOWN FOR REFERENCE ONLY.
- F. THESE DIMENSIONS APPLY TO THE FLAT SECTION OF THE LEAD BETWEEN 0.08mm AND 0.15mm FROM THE LEAD TIP.
- G. LANDPATTERN RECOMMENDATION PER IPC SOTFL95P240X100-4N (ADAPTED TO 3LD)
- H. DRAWING FILE NUMBER AND REVISION: MKT-MA03EREV1.DWG

Figure 21. 3-LEAD, SOT23, FLAT LEAD, LOW PROFILE



**TRADEMARKS**

The following includes registered and unregistered trademarks and service marks, owned by Fairchild Semiconductor and/or its global subsidiaries, and is not intended to be an exhaustive list of all such trademarks.

- |  |  |   |   |
|--|--|---|---|
| AccuPower™   | F-PFS™   | OPTOPLANAR®   |  SYSTEM GENERAL® |
| AttitudeEngine™  | FRFET®   |  ® | TinyBoost®  |
| Awinda®  | Global Power Resource™                         | PowerTrench®  | TinyBuck®   |
| AX-CAP®*   | GreenBridge™                                   | PowerXS™  | TinyCalc™   |
| BitSiC™  | Green FPS™                                     | Programmable Active Droop™  | TinyLogic®  |
| Build it Now™  | Green FPS™ e-Series™                           | QFET®   | TINYOPTO™   |
| CorePLUS™  | Gmax™  | QS™   | TinyPower™  |
| CorePOWER™   | GTO™   | Quiet Series™   | TinyPWM™  |
| CROSSVOLT™   | IntelliMAX™                                    | RapidConfigure™   | TinyWire™   |
| CTL™   | ISOPLANAR™                                     |  ™ | TranSiC™  |
| Current Transfer Logic™  | Making Small Speakers Sound Louder and Better™ | Saving our world, 1mW/W/kW at a time™   | TriFault Detect™  |
| DEUXPEED®  | MegaBuck™                                      | SignalWise™   | TRUECURRENT®*   |
| Dual Cool™   | MICROCOUPLER™                                  | SmartMax™   | µSerDes™  |
| EcoSPARK®  | MicroFET™                                      | SMART START™  |  SerDes™         |
| EfficientMax™  | MicroPak™                                      | Solutions for Your Success™   | UHC®  |
| ESBC™  | MicroPak2™                                     | SPM®  | Ultra FRFET™  |
|  Fairchild® | MillerDrive™                                   | STEALTH™  | UniFET™   |
| Fairchild Semiconductor®   | MotionMax™                                     | SuperFET®   | VCX™  |
| FACT Quiet Series™   | MotionGrid®                                    | SuperSOT™-3   | VisualMax™  |
| FACT®  | MTi®   | SuperSOT™-6   | VoltagePlus™  |
| FAST®  | MTx®   | SuperSOT™-8   | XS™   |
| FastvCore™   | MVN®   | SupreMOS®   | Xsens™  |
| FETBench™  | mWSaver®                                       | SyncFET™  | 仙童™   |
| FPS™   | OptoHiT™                                       | Sync-Lock™  |   |
|  | OPTOLOGIC®                                     |   |   |

\* Trademarks of System General Corporation, used under license by Fairchild Semiconductor.

**DISCLAIMER**

FAIRCHILD SEMICONDUCTOR RESERVES THE RIGHT TO MAKE CHANGES WITHOUT FURTHER NOTICE TO ANY PRODUCTS HEREIN TO IMPROVE RELIABILITY, FUNCTION, OR DESIGN. TO OBTAIN THE LATEST, MOST UP-TO-DATE DATASHEET AND PRODUCT INFORMATION, VISIT OUR WEBSITE AT [HTTP://WWW.FAIRCHILDSEMI.COM](http://www.fairchildsemi.com). FAIRCHILD DOES NOT ASSUME ANY LIABILITY ARISING OUT OF THE APPLICATION OR USE OF ANY PRODUCT OR CIRCUIT DESCRIBED HEREIN; NEITHER DOES IT CONVEY ANY LICENSE UNDER ITS PATENT RIGHTS, NOR THE RIGHTS OF OTHERS. THESE SPECIFICATIONS DO NOT EXPAND THE TERMS OF FAIRCHILD'S WORLDWIDE TERMS AND CONDITIONS, SPECIFICALLY THE WARRANTY THEREIN, WHICH COVERS THESE PRODUCTS.

**LIFE SUPPORT POLICY**

FAIRCHILD'S PRODUCTS ARE NOT AUTHORIZED FOR USE AS CRITICAL COMPONENTS IN LIFE SUPPORT DEVICES OR SYSTEMS WITHOUT THE EXPRESS WRITTEN APPROVAL OF FAIRCHILD SEMICONDUCTOR CORPORATION.

As used herein:

1. Life support devices or systems are devices or systems which, (a) are intended for surgical implant into the body or (b) support or sustain life, and (c) whose failure to perform when properly used in accordance with instructions for use provided in the labeling, can be reasonably expected to result in a significant injury of the user.
2. A critical component in any component of a life support, device, or system whose failure to perform can be reasonably expected to cause the failure of the life support device or system, or to affect its safety or effectiveness.

**ANTI-COUNTERFEITING POLICY**

Fairchild Semiconductor Corporation's Anti-Counterfeiting Policy. Fairchild's Anti-Counterfeiting Policy is also stated on our external website, [www.fairchildsemi.com](http://www.fairchildsemi.com), under Sales Support.

Counterfeiting of semiconductor parts is a growing problem in the industry. All manufacturers of semiconductor products are experiencing counterfeiting of their parts. Customers who inadvertently purchase counterfeit parts experience many problems such as loss of brand reputation, substandard performance, failed applications, and increased cost of production and manufacturing delays. Fairchild is taking strong measures to protect ourselves and our customers from the proliferation of counterfeit parts. Fairchild strongly encourages customers to purchase Fairchild parts either directly from Fairchild or from Authorized Fairchild Distributors who are listed by country on our web page cited above. Products customers buy either from Fairchild directly or from Authorized Fairchild Distributors are genuine parts, have full traceability, meet Fairchild's quality standards for handling and storage and provide access to Fairchild's full range of up-to-date technical and product information. Fairchild and our Authorized Distributors will stand behind all warranties and will appropriately address any warranty issues that may arise. Fairchild will not provide any warranty coverage or other assistance for parts bought from Unauthorized Sources. Fairchild is committed to combat this global problem and encourage our customers to do their part in stopping this practice by buying direct or from authorized distributors.

**PRODUCT STATUS DEFINITIONS**

**Definition of Terms**

Datasheet Identification	Product Status	Definition
Advance Information	Formative / In Design	Datasheet contains the design specifications for product development. Specifications may change in any manner without notice.
Preliminary	First Production	Datasheet contains preliminary data; supplementary data will be published at a later date. Fairchild Semiconductor reserves the right to make changes at any time without notice to improve design.
No Identification Needed	Full Production	Datasheet contains final specifications. Fairchild Semiconductor reserves the right to make changes at any time without notice to improve the design.
Obsolete	Not In Production	Datasheet contains specifications on a product that is discontinued by Fairchild Semiconductor. The datasheet is for reference information only.

Rev. I73

ON Semiconductor and  are trademarks of Semiconductor Components Industries, LLC dba ON Semiconductor or its subsidiaries in the United States and/or other countries. ON Semiconductor owns the rights to a number of patents, trademarks, copyrights, trade secrets, and other intellectual property. A listing of ON Semiconductor's product/patent coverage may be accessed at [www.onsemi.com/site/pdf/Patent-Marking.pdf](http://www.onsemi.com/site/pdf/Patent-Marking.pdf). ON Semiconductor reserves the right to make changes without further notice to any products herein. ON Semiconductor makes no warranty, representation or guarantee regarding the suitability of its products for any particular purpose, nor does ON Semiconductor assume any liability arising out of the application or use of any product or circuit, and specifically disclaims any and all liability, including without limitation special, consequential or incidental damages. Buyer is responsible for its products and applications using ON Semiconductor products, including compliance with all laws, regulations and safety requirements or standards, regardless of any support or applications information provided by ON Semiconductor. "Typical" parameters which may be provided in ON Semiconductor data sheets and/or specifications can and do vary in different applications and actual performance may vary over time. All operating parameters, including "Typicals" must be validated for each customer application by customer's technical experts. ON Semiconductor does not convey any license under its patent rights nor the rights of others. ON Semiconductor products are not designed, intended, or authorized for use as a critical component in life support systems or any FDA Class 3 medical devices or medical devices with a same or similar classification in a foreign jurisdiction or any devices intended for implantation in the human body. Should Buyer purchase or use ON Semiconductor products for any such unintended or unauthorized application, Buyer shall indemnify and hold ON Semiconductor and its officers, employees, subsidiaries, affiliates, and distributors harmless against all claims, costs, damages, and expenses, and reasonable attorney fees arising out of, directly or indirectly, any claim of personal injury or death associated with such unintended or unauthorized use, even if such claim alleges that ON Semiconductor was negligent regarding the design or manufacture of the part. ON Semiconductor is an Equal Opportunity/Affirmative Action Employer. This literature is subject to all applicable copyright laws and is not for resale in any manner.

## PUBLICATION ORDERING INFORMATION

### LITERATURE FULFILLMENT:

Literature Distribution Center for ON Semiconductor  
19521 E. 32nd Pkwy, Aurora, Colorado 80011 USA  
**Phone:** 303-675-2175 or 800-344-3860 Toll Free USA/Canada  
**Fax:** 303-675-2176 or 800-344-3867 Toll Free USA/Canada  
**Email:** [orderlit@onsemi.com](mailto:orderlit@onsemi.com)

**N. American Technical Support:** 800-282-9855 Toll Free  
USA/Canada  
**Europe, Middle East and Africa Technical Support:**  
Phone: 421 33 790 2910  
**Japan Customer Focus Center**  
Phone: 81-3-5817-1050

**ON Semiconductor Website:** [www.onsemi.com](http://www.onsemi.com)  
**Order Literature:** <http://www.onsemi.com/orderlit>  
For additional information, please contact your local  
Sales Representative