

FEATURES

Output frequency range: 35 MHz to 4400 MHz
Fractional-N synthesizer and integer-N synthesizer
Low phase noise VCO
Programmable divide-by-1/-2/-4/-8/-16/-32/-64 output
Typical jitter: 0.3 ps rms
Typical EVM at 2.1 GHz: 0.4%
Power supply: 3.0 V to 3.6 V
Logic compatibility: 1.8 V
Programmable dual-modulus prescaler of 4/5 or 8/9
Programmable output power level
RF output mute function
3-wire serial interface
Analog and digital lock detect
Switched bandwidth fast lock mode
Cycle slip reduction

APPLICATIONS

**Wireless infrastructure (W-CDMA, TD-SCDMA, WiMAX,
GSM, PCS, DCS, DECT)**
Test equipment
Wireless LANs, CATV equipment
Clock generation

GENERAL DESCRIPTION

The ADF4351 allows implementation of fractional-N or integer-N phase-locked loop (PLL) frequency synthesizers when used with an external loop filter and external reference frequency.

The ADF4351 has an integrated voltage controlled oscillator (VCO) with a fundamental output frequency ranging from 2200 MHz to 4400 MHz. In addition, divide-by-1/-2/-4/-8/-16/-32/-64 circuits allow the user to generate RF output frequencies as low as 35 MHz. For applications that require isolation, the RF output stage can be muted. The mute function is both pin- and software-controllable. An auxiliary RF output is also available, which can be powered down when not in use.

Control of all on-chip registers is through a simple 3-wire interface. The device operates with a power supply ranging from 3.0 V to 3.6 V and can be powered down when not in use.

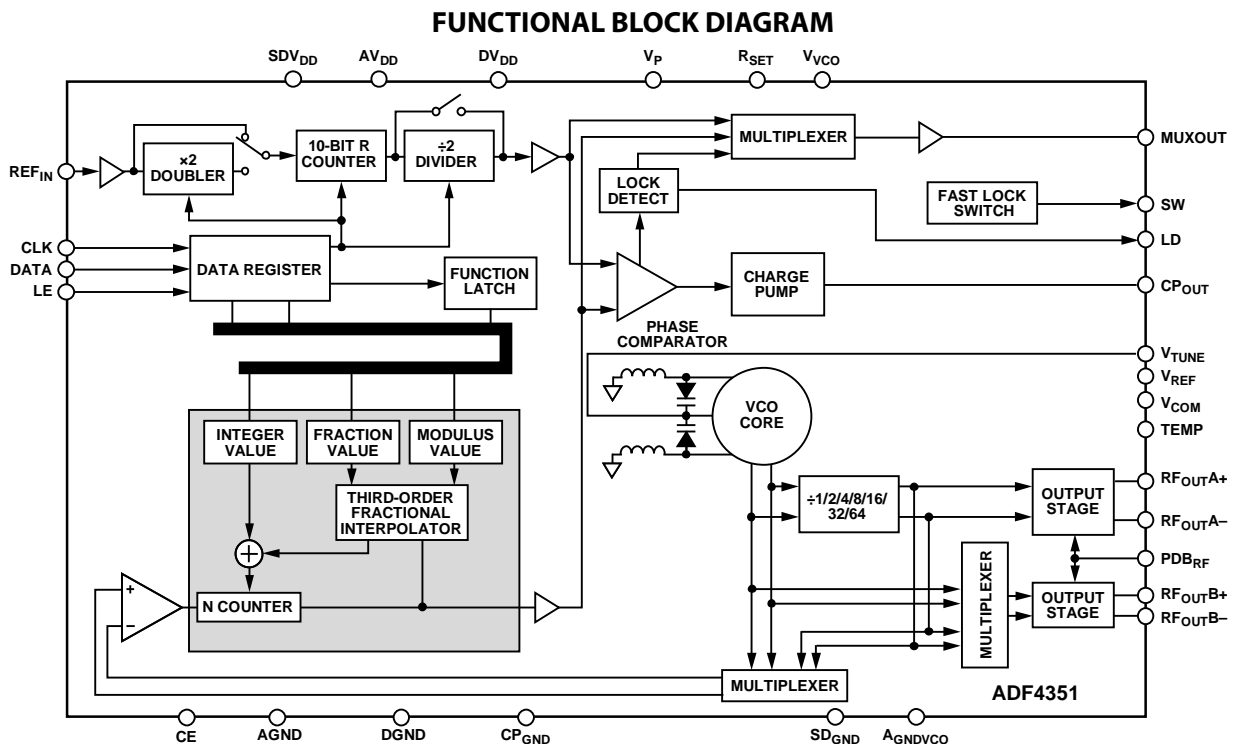

Figure 1.

Rev. 0

Information furnished by Analog Devices is believed to be accurate and reliable. However, no responsibility is assumed by Analog Devices for its use, nor for any infringements of patents or other rights of third parties that may result from its use. Specifications subject to change without notice. No license is granted by implication or otherwise under any patent or patent rights of Analog Devices. Trademarks and registered trademarks are the property of their respective owners.

ADF4351* Product Page Quick Links

Last Content Update: 10/05/2016

Comparable Parts

View a parametric search of comparable parts

Evaluation Kits

- AD-FMCOMMS6-EBZ Evaluation Board
- ADF4351 Evaluation Board
- FPGA Mezzanine Card for Wireless Communications
- TX/RX channels, Frequency conversion from 1 100 MHz up to 400 MHz

Documentation

Data Sheet

- ADF4351: Wideband Synthesizer with Integrated VCO Datasheet

User Guides

- UG-435: Evaluation Board for the ADF4351 Fractional-N PLL Frequency Synthesizer
- UG-476: PLL Software Installation Guide
- UG-521: Evaluating the CN-0285 Wideband Tx Modulator Solution

Software and Systems Requirements

- ADF4350 IIO Wideband Synthesizer Linux Driver

Tools and Simulations

- ADIsimPLL™
- ADIsimRF
- ADF4350 IBIS Model

Reference Designs

- CN0239
- CN0285
- CN0294
- CN0311
- CN0360

Reference Materials

Informational

- SDR: Software Defined Revolution

Press

- Analog Devices' 4-GHz PLL Synthesizer Offers Leading Phase Noise Performance
- New Analog Devices' PLL Synthesizers Deliver Utmost Flexibility and Phase Noise Performance

Product Selection Guide

- RF Source Booklet

Design Resources

- ADF4351 Material Declaration
- PCN-PDN Information
- Quality And Reliability
- Symbols and Footprints

Discussions

View all ADF4351 EngineerZone Discussions

Sample and Buy

Visit the product page to see pricing options

Technical Support

Submit a technical question or find your regional support number

* This page was dynamically generated by Analog Devices, Inc. and inserted into this data sheet. Note: Dynamic changes to the content on this page does not constitute a change to the revision number of the product data sheet. This content may be frequently modified.

TABLE OF CONTENTS

Features	1	Register 1	18
Applications.....	1	Register 2	18
General Description	1	Register 3	19
Functional Block Diagram	1	Register 4	20
Revision History	2	Register 5	20
Specifications.....	3	Register Initialization Sequence	20
Timing Characteristics	5	RF Synthesizer—A Worked Example	21
Absolute Maximum Ratings.....	6	Reference Doubler and Reference Divider	21
Transistor Count.....	6	12-Bit Programmable Modulus	21
Thermal Resistance	6	Cycle Slip Reduction for Faster Lock Times.....	22
ESD Caution.....	6	Spurious Optimization and Fast Lock.....	22
Pin Configuration and Function Descriptions.....	7	Fast Lock Timer and Register Sequences.....	22
Typical Performance Characteristics	9	Fast Lock Example	22
Circuit Description.....	11	Fast Lock Loop Filter Topology.....	23
Reference Input Section.....	11	Spur Mechanisms	23
RF N Divider.....	11	Spur Consistency and Fractional Spur Optimization	24
Phase Frequency Detector (PFD) and Charge Pump.....	11	Phase Resync.....	24
MUXOUT and Lock Detect.....	12	Applications Information	25
Input Shift Registers.....	12	Direct Conversion Modulator	25
Program Modes	12	Interfacing to the ADuC70xx and the ADSP-BF527	26
VCO.....	12	PCB Design Guidelines for a Chip Scale Package	26
Output Stage.....	13	Output Matching	27
Register Maps	14	Outline Dimensions	28
Register 0	18	Ordering Guide	28

REVISION HISTORY

5/12—Revision 0: Initial Version

SPECIFICATIONS

$AV_{DD} = DV_{DD} = V_{VCO} = SDV_{DD} = V_P = 3.3 \text{ V} \pm 10\%$; $AGND = DGND = 0 \text{ V}$; $T_A = T_{MIN}$ to T_{MAX} , unless otherwise noted. Operating temperature range is -40°C to $+85^\circ\text{C}$.

Table 1.

Parameter	Min	Typ	Max	Unit	Test Conditions/Comments
REF_{IN} CHARACTERISTICS					
Input Frequency	10		250	MHz	For $f < 10 \text{ MHz}$, ensure slew rate $> 21 \text{ V}/\mu\text{s}$ Biased at $AV_{DD}/2$; ac coupling ensures $AV_{DD}/2$ bias
Input Sensitivity	0.7		AV_{DD}	V p-p	
Input Capacitance		10		pF	
Input Current			± 60	μA	
PHASE FREQUENCY DETECTOR (PFD)					
Phase Detector Frequency			32	MHz	Fractional-N
			45	MHz	Integer-N (band select enabled)
			90	MHz	Integer-N (band select disabled)
CHARGE PUMP					
I_{CP} Sink/Source ¹					$R_{SET} = 5.1 \text{ k}\Omega$
High Value		5		mA	
Low Value		0.312		mA	
R_{SET} Range	3.9		10	k Ω	
Sink and Source Current Matching		2		%	$0.5 \text{ V} \leq V_{CP} \leq 2.5 \text{ V}$
I_{CP} vs. V_{CP}		1.5		%	$0.5 \text{ V} \leq V_{CP} \leq 2.5 \text{ V}$
I_{CP} vs. Temperature		2		%	$V_{CP} = 2.0 \text{ V}$
LOGIC INPUTS					
Input High Voltage, V_{INH}	1.5			V	
Input Low Voltage, V_{INL}			0.6	V	
Input Current, I_{INH}/I_{INL}			± 1	μA	
Input Capacitance, C_{IN}		3.0		pF	
LOGIC OUTPUTS					
Output High Voltage, V_{OH}	$DV_{DD} - 0.4$			V	CMOS output selected
Output High Current, I_{OH}			500	μA	
Output Low Voltage, V_{OL}			0.4	V	$I_{OL} = 500 \mu\text{A}$
POWER SUPPLIES					
AV_{DD}	3.0		3.6	V	These voltages must equal AV_{DD}
DV_{DD} , V_{VCO} , SDV_{DD} , V_P		AV_{DD}			
$DI_{DD} + AI_{DD}^2$		21	27	mA	Each output divide-by-2 consumes 6 mA
Output Dividers		6 to 36		mA	
I_{VCO}^2		70	80	mA	RF output stage is programmable
I_{RFOUT}^2		21	26	mA	
Low Power Sleep Mode		7	10	μA	
RF OUTPUT CHARACTERISTICS					
VCO Output Frequency	2200		4400	MHz	Fundamental VCO mode 2200 MHz fundamental output and divide-by-64 selected
Minimum VCO Output Frequency Using Dividers	34.375			MHz	
VCO Sensitivity, K_V		40		MHz/V	Into 2.00 VSWR load Fundamental VCO output Divided VCO output Fundamental VCO output Divided VCO output
Frequency Pushing (Open-Loop)		1		MHz/V	
Frequency Pulling (Open-Loop)		90		kHz	
Harmonic Content (Second)		-19		dBc	
		-20		dBc	
Harmonic Content (Third)		-13		dBc	
		-10		dBc	

Parameter	Min	Typ	Max	Unit	Test Conditions/Comments
Minimum RF Output Power ³		-4		dBm	Programmable in 3 dB steps
Maximum RF Output Power ³		5		dBm	
Output Power Variation		±1		dB	
Minimum VCO Tuning Voltage		0.5		V	
Maximum VCO Tuning Voltage		2.5		V	
NOISE CHARACTERISTICS					
VCO Phase Noise Performance					VCO noise is measured in open-loop conditions
		-89		dBc/Hz	10 kHz offset from 2.2 GHz carrier
		-114		dBc/Hz	100 kHz offset from 2.2 GHz carrier
		-134		dBc/Hz	1 MHz offset from 2.2 GHz carrier
		-148		dBc/Hz	5 MHz offset from 2.2 GHz carrier
		-86		dBc/Hz	10 kHz offset from 3.3 GHz carrier
		-111		dBc/Hz	100 kHz offset from 3.3 GHz carrier
		-134		dBc/Hz	1 MHz offset from 3.3 GHz carrier
		-145		dBc/Hz	5 MHz offset from 3.3 GHz carrier
		-83		dBc/Hz	10 kHz offset from 4.4 GHz carrier
		-110		dBc/Hz	100 kHz offset from 4.4 GHz carrier
		-131		dBc/Hz	1 MHz offset from 4.4 GHz carrier
		-145		dBc/Hz	5 MHz offset from 4.4 GHz carrier
Normalized Phase Noise Floor (PN_{SYNTH}) ⁴		-220		dBc/Hz	ABP = 6 ns
		-221		dBc/Hz	ABP = 3 ns
Normalized 1/f Noise ($PN_{1/f}$) ⁵					10 kHz offset; normalized to 1 GHz
		-116		dBc/Hz	ABP = 6 ns
		-118		dBc/Hz	ABP = 3 ns
In-Band Phase Noise		-100		dBc/Hz	3 kHz from 2111.28 MHz carrier
Integrated RMS Jitter ⁶		0.27		ps	
Spurious Signals Due to PFD Frequency		-80		dBc	
Level of Signal with RF Mute Enabled		-40		dBm	

¹ I_{CP} is internally modified to maintain constant loop gain over the frequency range.

² $T_A = 25^\circ\text{C}$; $AV_{DD} = DV_{DD} = V_{VCO} = 3.3\text{ V}$; prescaler = 8/9; $f_{REFIN} = 100\text{ MHz}$; $f_{PFD} = 25\text{ MHz}$; $f_{RF} = 4.4\text{ GHz}$.

³ Using 50 Ω resistors to V_{VCO} , into a 50 Ω load. Power measured with auxiliary RF output disabled. The current consumption of the auxiliary output is the same as for the main output.

⁴ The synthesizer phase noise floor is estimated by measuring the in-band phase noise at the output of the VCO and subtracting $20 \log N$ (where N is the N divider value) and $10 \log f_{PFD}$. To calculate in-band phase noise performance as seen at the VCO output, use the following formula: $PN_{SYNTH} = PN_{TOT} - 10 \log(f_{PFD}) - 20 \log N$.

⁵ The PLL phase noise is composed of flicker (1/f) noise plus the normalized PLL noise floor. The formula for calculating the 1/f noise contribution at an RF frequency (f_{RF}) and at a frequency offset (f) is given by $PN = PN_{1/f} + 10 \log(10 \text{ kHz}/f) + 20 \log(f_{RF}/1 \text{ GHz})$. Both the normalized phase noise floor and flicker noise are modeled in [ADIsimPLL](#).

⁶ $f_{REFIN} = 122.88\text{ MHz}$; $f_{PFD} = 30.72\text{ MHz}$; VCO frequency = 4222.56 MHz; $f_{RF_OUT} = 2111.28\text{ MHz}$; N = 137; loop BW = 60 kHz; $I_{CP} = 2.5\text{ mA}$; low noise mode. The noise was measured with an EVAL-ADF4351EB1Z and the Rohde & Schwarz FSUP signal source analyzer.

TIMING CHARACTERISTICS

$AV_{DD} = DV_{DD} = V_{VCO} = SDV_{DD} = V_p = 3.3\text{ V} \pm 10\%$; $AGND = DGND = 0\text{ V}$; 1.8 V and 3 V logic levels used; $T_A = T_{MIN}$ to T_{MAX} , unless otherwise noted.

Table 2.

Parameter	Limit	Unit	Description
t_1	20	ns min	LE setup time
t_2	10	ns min	DATA to CLK setup time
t_3	10	ns min	DATA to CLK hold time
t_4	25	ns min	CLK high duration
t_5	25	ns min	CLK low duration
t_6	10	ns min	CLK to LE setup time
t_7	20	ns min	LE pulse width

Timing Diagram

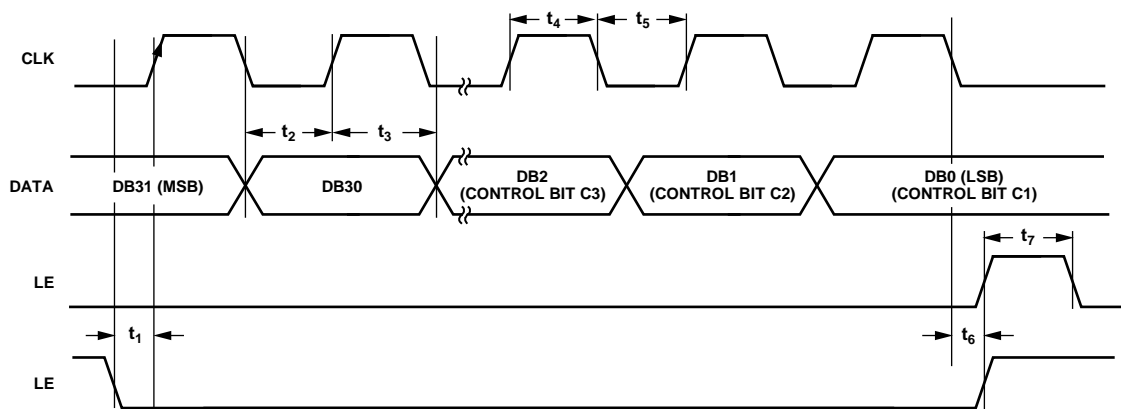

Figure 2. Timing Diagram

09800-C02

ABSOLUTE MAXIMUM RATINGS

$T_A = 25^\circ\text{C}$, unless otherwise noted.

Table 3.

Parameter	Rating
AV_{DD} to GND ¹	-0.3 V to +3.9 V
AV_{DD} to DV_{DD}	-0.3 V to +0.3 V
V_{VCO} to GND ¹	-0.3 V to +3.9 V
V_{VCO} to AV_{DD}	-0.3 V to +0.3 V
Digital I/O Voltage to GND ¹	-0.3 V to $V_{DD} + 0.3$ V
Analog I/O Voltage to GND ¹	-0.3 V to $V_{DD} + 0.3$ V
REF_{IN} to GND ¹	-0.3 V to $V_{DD} + 0.3$ V
Operating Temperature Range	-40°C to +85°C
Storage Temperature Range	-65°C to +125°C
Maximum Junction Temperature	150°C
Reflow Soldering	
Peak Temperature	260°C
Time at Peak Temperature	40 sec

¹ GND = AGND = DGND = CP_{GND} = SD_{GND} = A_{GNDVCO} = 0 V.

Stresses above those listed under Absolute Maximum Ratings may cause permanent damage to the device. This is a stress rating only; functional operation of the device at these or any other conditions above those indicated in the operational section of this specification is not implied. Exposure to absolute maximum rating conditions for extended periods may affect device reliability.

This device is a high performance RF integrated circuit with an ESD rating of <1.5 kV and is ESD sensitive. Proper precautions should be taken for handling and assembly.

TRANSISTOR COUNT

The transistor count for the ADF4351 is 36,955 (CMOS) and 986 (bipolar).

THERMAL RESISTANCE

Thermal impedance (θ_{JA}) is specified for a device with the exposed pad soldered to GND.

Table 4. Thermal Resistance

Package Type	θ_{JA}	Unit
32-Lead LFCSP (CP-32-2)	27.3	°C/W

ESD CAUTION



ESD (electrostatic discharge) sensitive device. Charged devices and circuit boards can discharge without detection. Although this product features patented or proprietary protection circuitry, damage may occur on devices subjected to high energy ESD. Therefore, proper ESD precautions should be taken to avoid performance degradation or loss of functionality.

PIN CONFIGURATION AND FUNCTION DESCRIPTIONS

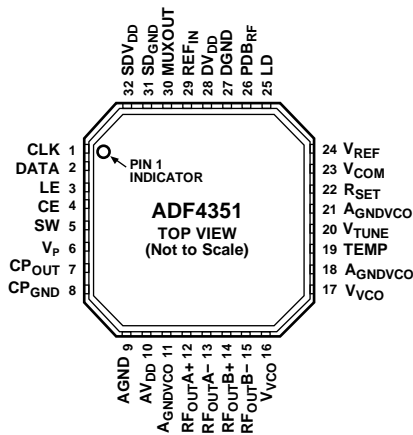

NOTES
1. THE LFCSP HAS AN EXPOSED PAD THAT MUST BE CONNECTED TO GND.

09800-003

Figure 3. Pin Configuration

Table 5. Pin Function Descriptions

Pin No.	Mnemonic	Description
1	CLK	Serial Clock Input. Data is clocked into the 32-bit shift register on the CLK rising edge. This input is a high impedance CMOS input.
2	DATA	Serial Data Input. The serial data is loaded MSB first with the three LSBs as the control bits. This input is a high impedance CMOS input.
3	LE	Load Enable. When LE goes high, the data stored in the 32-bit shift register is loaded into the register that is selected by the three control bits. This input is a high impedance CMOS input.
4	CE	Chip Enable. A logic low on this pin powers down the device and puts the charge pump into three-state mode. A logic high on this pin powers up the device, depending on the status of the power-down bits.
5	SW	Fast Lock Switch. A connection should be made from the loop filter to this pin when using the fast lock mode.
6	V _p	Charge Pump Power Supply. V _p must have the same value as AV _{DD} . Place decoupling capacitors to the ground plane as close to this pin as possible.
7	CP _{OUT}	Charge Pump Output. When enabled, this output provides ±I _{CP} to the external loop filter. The output of the loop filter is connected to V _{TUNE} to drive the internal VCO.
8	CP _{GND}	Charge Pump Ground. This output is the ground return pin for CP _{OUT} .
9	AGND	Analog Ground. Ground return pin for AV _{DD} .
10	AV _{DD}	Analog Power Supply. This pin ranges from 3.0 V to 3.6 V. Place decoupling capacitors to the analog ground plane as close to this pin as possible. AV _{DD} must have the same value as DV _{DD} .
11, 18, 21	AGNDVCO	VCO Analog Ground. Ground return pins for the VCO.
12	RF _{OUTA+}	VCO Output. The output level is programmable. The VCO fundamental output or a divided-down version is available.
13	RF _{OUTA-}	Complementary VCO Output. The output level is programmable. The VCO fundamental output or a divided-down version is available.
14	RF _{OUTB+}	Auxiliary VCO Output. The output level is programmable. The VCO fundamental output or a divided-down version is available.
15	RF _{OUTB-}	Complementary Auxiliary VCO Output. The output level is programmable. The VCO fundamental output or a divided-down version is available.
16, 17	V _{VCO}	Power Supply for the VCO. This pin ranges from 3.0 V to 3.6 V. Place decoupling capacitors to the analog ground plane as close to these pins as possible. V _{VCO} must have the same value as AV _{DD} .
19	TEMP	Temperature Compensation Output. Place decoupling capacitors to the ground plane as close to this pin as possible.
20	V _{TUNE}	Control Input to the VCO. This voltage determines the output frequency and is derived from filtering the CP _{OUT} output voltage.

Pin No.	Mnemonic	Description
22	R _{SET}	Connecting a resistor between this pin and ground sets the charge pump output current. The nominal voltage bias at the R _{SET} pin is 0.55 V. The relationship between I _{CP} and R _{SET} is as follows: $I_{CP} = 25.5/R_{SET}$ where: $R_{SET} = 5.1 \text{ k}\Omega$. $I_{CP} = 5 \text{ mA}$.
23	V _{COM}	Internal Compensation Node. Biased at half the tuning range. Place decoupling capacitors to the ground plane as close to this pin as possible.
24	V _{REF}	Reference Voltage. Place decoupling capacitors to the ground plane as close to this pin as possible.
25	LD	Lock Detect Output Pin. A logic high output on this pin indicates PLL lock. A logic low output indicates loss of PLL lock.
26	PDB _{RF}	RF Power-Down. A logic low on this pin mutes the RF outputs. This function is also software controllable.
27	DGND	Digital Ground. Ground return pin for DV _{DD} .
28	DV _{DD}	Digital Power Supply. DV _{DD} must have the same value as AV _{DD} . Place decoupling capacitors to the ground plane as close to this pin as possible.
29	REF _{IN}	Reference Input. This CMOS input has a nominal threshold of AV _{DD} /2 and a dc equivalent input resistance of 100 k Ω . This input can be driven from a TTL or CMOS crystal oscillator, or it can be ac-coupled.
30	MUXOUT	Multiplexer Output. The multiplexer output allows the lock detect value, the N divider value, or the R counter value to be accessed externally.
31	SD _{GND}	Digital Σ - Δ Modulator Ground. Ground return pin for the Σ - Δ modulator.
32	SDV _{DD}	Power Supply Pin for the Digital Σ - Δ Modulator. SDV _{DD} must have the same value as AV _{DD} . Place decoupling capacitors to the ground plane as close to this pin as possible.
EP	Exposed Pad	Exposed Pad. The LFCSP has an exposed pad that must be connected to GND.

TYPICAL PERFORMANCE CHARACTERISTICS

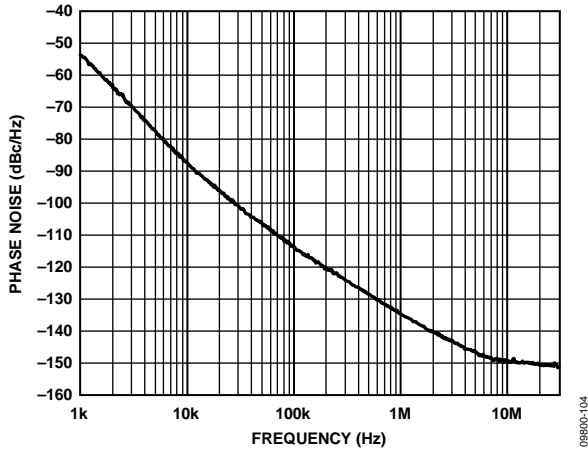

Figure 4. Open-Loop VCO Phase Noise, 2.2 GHz

09800-104

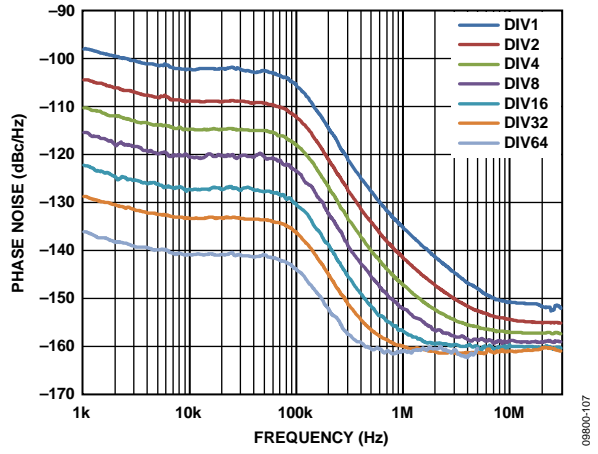

Figure 7. Closed-Loop Phase Noise, Fundamental VCO and Dividers, VCO = 2.2 GHz, PFD = 25 MHz, Loop Filter Bandwidth = 63 kHz

09800-107

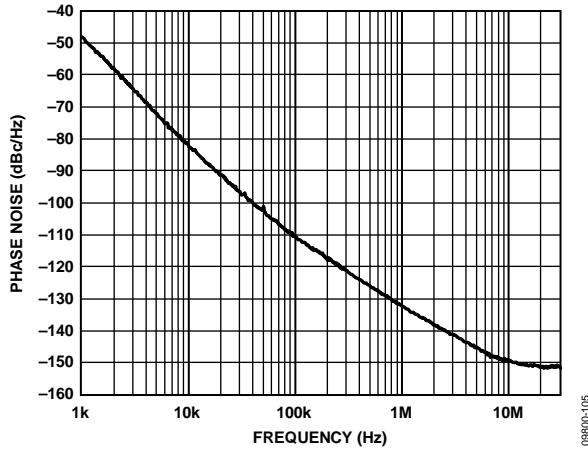

Figure 5. Open-Loop VCO Phase Noise, 3.3 GHz

09800-105

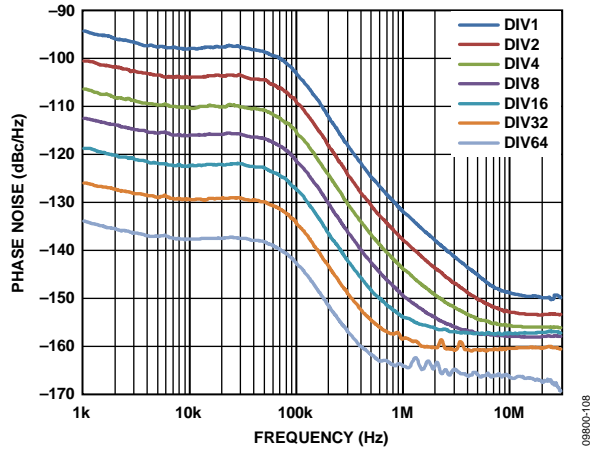

Figure 8. Closed-Loop Phase Noise, Fundamental VCO and Dividers, VCO = 3.3 GHz, PFD = 25 MHz, Loop Filter Bandwidth = 63 kHz

09800-108

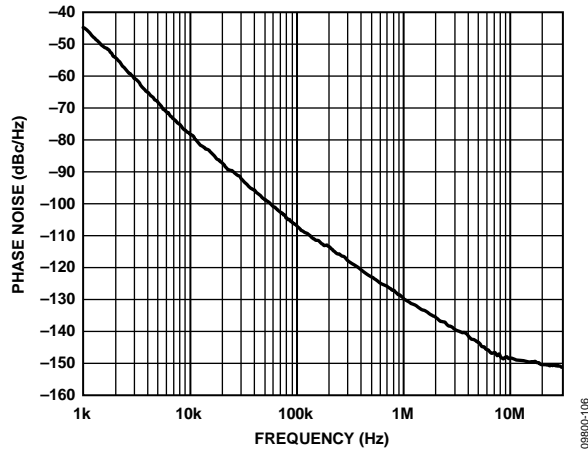

Figure 6. Open-Loop VCO Phase Noise, 4.4 GHz

09800-106

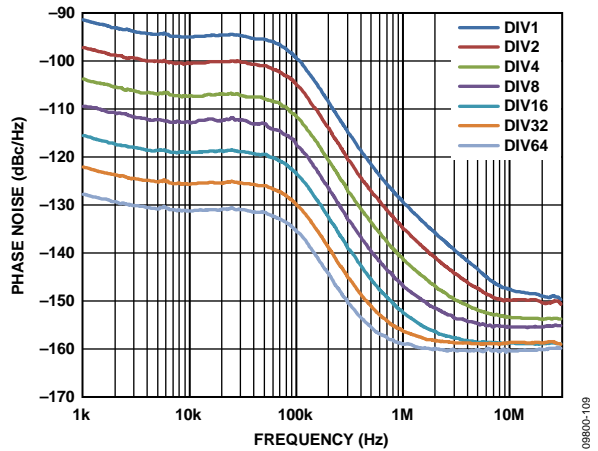

Figure 9. Closed-Loop Phase Noise, Fundamental VCO and Dividers, VCO = 4.4 GHz, PFD = 25 MHz, Loop Filter Bandwidth = 63 kHz

09800-109

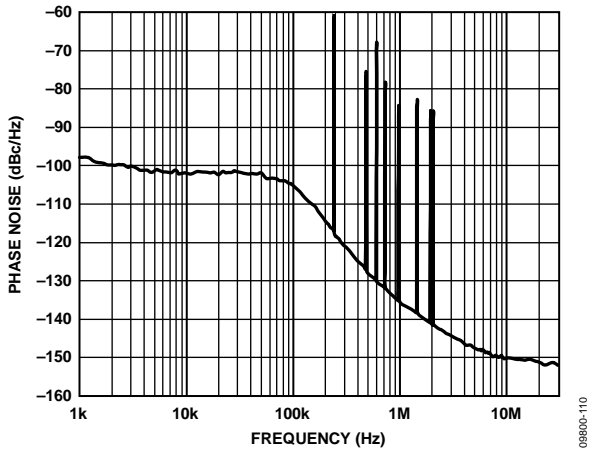

Figure 10. Fractional-N Spur Performance, Low Noise Mode, W-CDMA Band; $RF_{OUT} = 2111.28$ MHz, $REF_{IN} = 122.88$ MHz, $PF_D = 30.72$ MHz, Output Divide-by-2 Selected; Loop Filter Bandwidth = 60 kHz, Channel Spacing = 240 kHz; RMS Phase Error = 0.21°, RMS Jitter = 0.27 ps, EVM = 0.37%

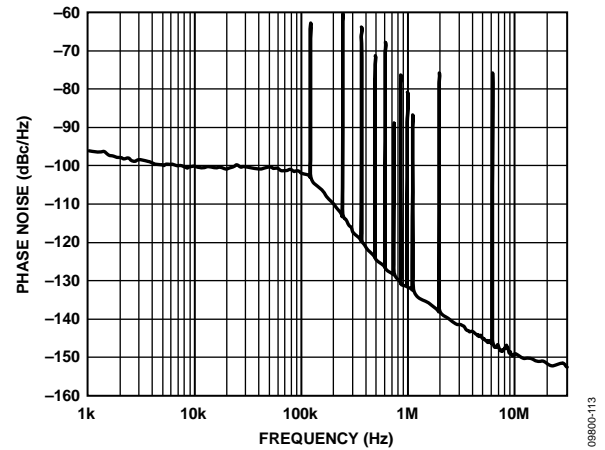

Figure 13. Fractional-N Spur Performance, Low Noise Mode, LTE Band; $RF_{OUT} = 2646.96$ MHz, $REF_{IN} = 122.88$ MHz, $PF_D = 30.72$ MHz; Loop Filter Bandwidth = 60 kHz, Channel Spacing = 240 kHz; Phase Word = 9, RMS Phase Error = 0.28°, RMS Jitter = 0.29 ps, EVM = 0.49%

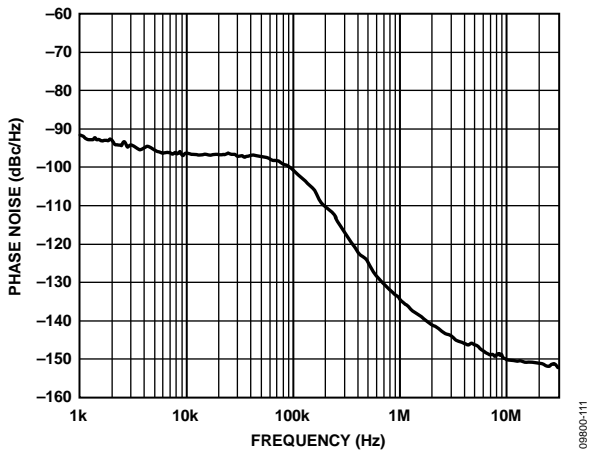

Figure 11. Fractional-N Spur Performance, Low Spur Mode, W-CDMA Band; $RF_{OUT} = 2111.28$ MHz, $REF_{IN} = 122.88$ MHz, $PF_D = 30.72$ MHz, Output Divide-by-2 Selected; Loop Filter Bandwidth = 60 kHz, Channel Spacing = 240 kHz; RMS Phase Error = 0.37°, RMS Jitter = 0.49 ps, EVM = 0.64%

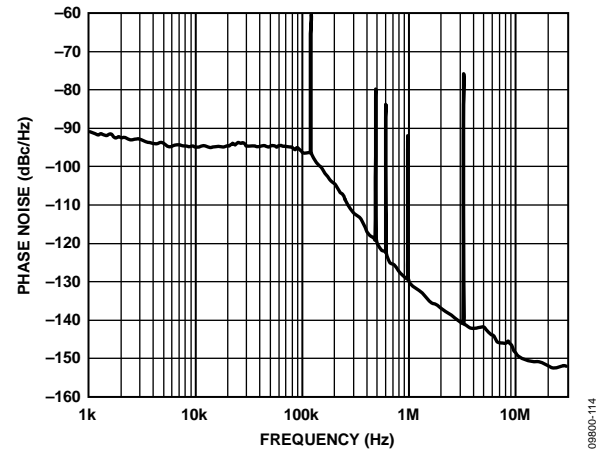

Figure 14. Fractional-N Spur Performance, Low Spur Mode, LTE Band; $RF_{OUT} = 2646.96$ MHz, $REF_{IN} = 122.88$ MHz, $PF_D = 30.72$ MHz; Loop Filter Bandwidth = 60 kHz, Channel Spacing = 240 kHz; RMS Phase Error = 0.56°, RMS Jitter = 0.59 ps, EVM = 0.98%

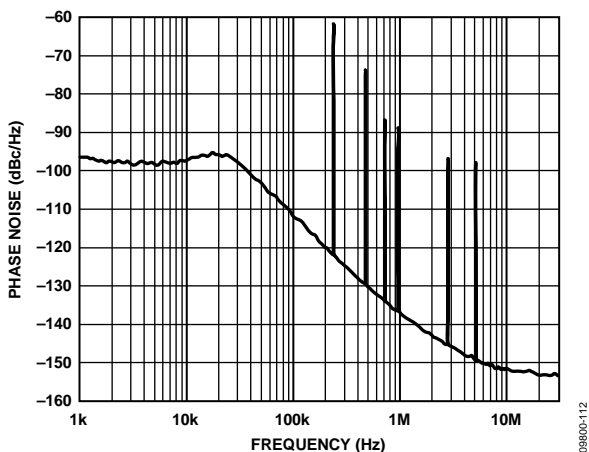

Figure 12. Fractional-N Spur Performance, Low Noise Mode, W-CDMA Band; $RF_{OUT} = 2111.28$ MHz, $REF_{IN} = 122.88$ MHz, $PF_D = 30.72$ MHz, Output Divide-by-2 Selected; Loop Filter Bandwidth = 20 kHz, Channel Spacing = 240 kHz; RMS Phase Error = 0.25°, RMS Jitter = 0.32 ps, EVM = 0.44%

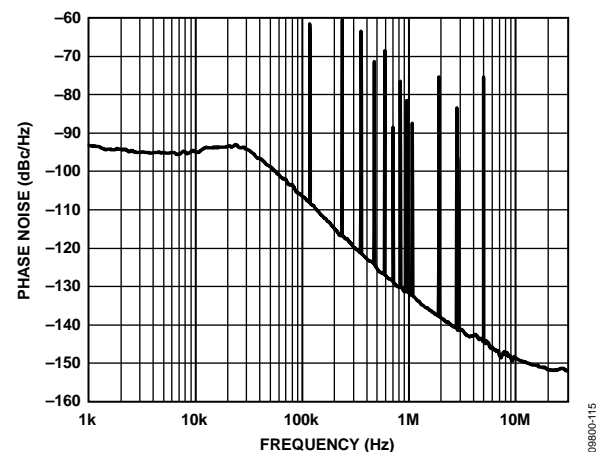

Figure 15. Fractional-N Spur Performance, Low Noise Mode, W-CDMA Band; $RF_{OUT} = 2646.96$ MHz, $REF_{IN} = 122.88$ MHz, $PF_D = 30.72$ MHz; Loop Filter Bandwidth = 20 kHz, Channel Spacing = 240 kHz; RMS Phase Error = 0.35°, RMS Jitter = 0.36 ps, EVM = 0.61%

CIRCUIT DESCRIPTION

REFERENCE INPUT SECTION

The reference input stage is shown in Figure 16. The SW1 and SW2 switches are normally closed. The SW3 switch is normally open. When power-down is initiated, SW3 is closed, and SW1 and SW2 are opened. In this way, no loading of the REF_{IN} pin occurs during power-down.

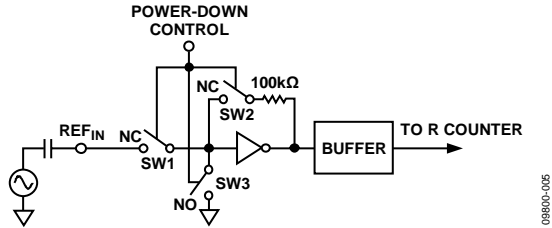

Figure 16. Reference Input Stage

RF N DIVIDER

The RF N divider allows a division ratio in the PLL feedback path. The division ratio is determined by the INT, FRAC, and MOD values, which build up this divider (see Figure 17).

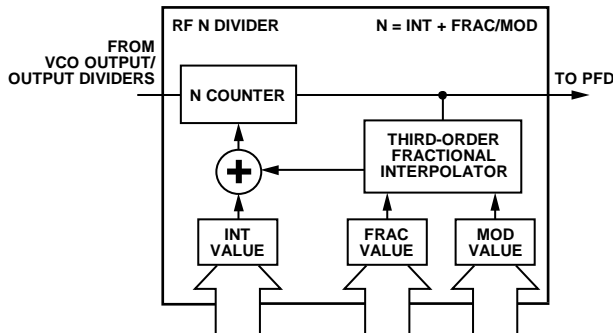

Figure 17. RF N Divider

INT, FRAC, MOD, and R Counter Relationship

The INT, FRAC, and MOD values, in conjunction with the R counter, make it possible to generate output frequencies that are spaced by fractions of the PFD frequency. For more information, see the RF Synthesizer—A Worked Example section.

The RF VCO frequency (RF_{OUT}) equation is

$$RF_{OUT} = f_{PFD} \times (INT + (FRAC/MOD)) \quad (1)$$

where:

RF_{OUT} is the output frequency of the voltage controlled oscillator (VCO).

INT is the preset divide ratio of the binary 16-bit counter (23 to 65,535 for the 4/5 prescaler; 75 to 65,535 for the 8/9 prescaler).

FRAC is the numerator of the fractional division (0 to MOD – 1).

MOD is the preset fractional modulus (2 to 4095).

The PFD frequency (f_{PFD}) equation is

$$f_{PFD} = REF_{IN} \times [(1 + D)/(R \times (1 + T))] \quad (2)$$

where:

REF_{IN} is the reference input frequency.

D is the REF_{IN} doubler bit (0 or 1).

R is the preset divide ratio of the binary 10-bit programmable reference counter (1 to 1023).

T is the REF_{IN} divide-by-2 bit (0 or 1).

Integer-N Mode

If FRAC = 0 and the DB8 (LDF) bit in Register 2 is set to 1, the synthesizer operates in integer-N mode. The DB8 bit in Register 2 should be set to 1 for integer-N digital lock detect.

R Counter

The 10-bit R counter allows the input reference frequency (REF_{IN}) to be divided down to produce the reference clock to the PFD. Division ratios from 1 to 1023 are allowed.

PHASE FREQUENCY DETECTOR (PFD) AND CHARGE PUMP

The phase frequency detector (PFD) takes inputs from the R counter and N counter and produces an output proportional to the phase and frequency difference between them. Figure 18 is a simplified schematic of the phase frequency detector.

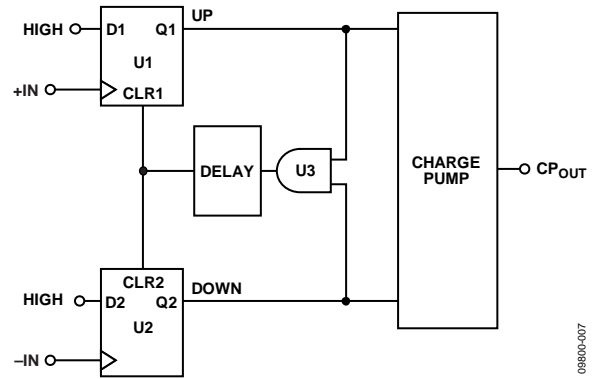

Figure 18. PFD Simplified Schematic

The PFD includes a programmable delay element that sets the width of the antibacklash pulse (ABP). This pulse ensures that there is no dead zone in the PFD transfer function. Bit DB22 in Register 3 (R3) is used to set the ABP as follows:

- When Bit DB22 is set to 0, the ABP width is programmed to 6 ns, the recommended value for fractional-N applications.
- When Bit DB22 is set to 1, the ABP width is programmed to 3 ns, the recommended value for integer-N applications.

For integer-N applications, the in-band phase noise is improved by enabling the shorter pulse width. The PFD frequency can operate up to 90 MHz in this mode. To operate with PFD frequencies higher than 45 MHz, VCO band select must be disabled by setting the phase adjust bit (DB28) to 1 in Register 1.

MUXOUT AND LOCK DETECT

The multiplexer output on the ADF4351 allows the user to access various internal points on the chip. The state of MUXOUT is controlled by the M3, M2, and M1 bits in Register 2 (see Figure 26). Figure 19 shows the MUXOUT section in block diagram form.

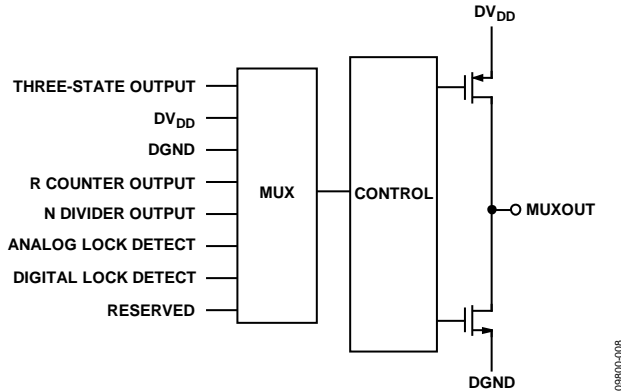

Figure 19. MUXOUT Schematic

INPUT SHIFT REGISTERS

The ADF4351 digital section includes a 10-bit RF R counter, a 16-bit RF N counter, a 12-bit FRAC counter, and a 12-bit modulus counter. Data is clocked into the 32-bit shift register on each rising edge of CLK. The data is clocked in MSB first. Data is transferred from the shift register to one of six latches on the rising edge of LE. The destination latch is determined by the state of the three control bits (C3, C2, and C1) in the shift register. As shown in Figure 2, the control bits are the three LSBs: DB2, DB1, and DB0. Table 6 shows the truth table for these bits. Figure 23 summarizes how the latches are programmed.

Table 6. Truth Table for the C3, C2, and C1 Control Bits

Control Bits			Register
C3	C2	C1	
0	0	0	Register 0 (R0)
0	0	1	Register 1 (R1)
0	1	0	Register 2 (R2)
0	1	1	Register 3 (R3)
1	0	0	Register 4 (R4)
1	0	1	Register 5 (R5)

PROGRAM MODES

Table 6 and Figure 23 through Figure 29 show how the program modes are set up in the ADF4351.

The following settings in the ADF4351 are double buffered: phase value, modulus value, reference doubler, reference divide-by-2, R counter value, and charge pump current setting. Before the part uses a new value for any double-buffered setting, the following two events must occur:

1. The new value is latched into the device by writing to the appropriate register.
2. A new write is performed on Register 0 (R0).

For example, any time that the modulus value is updated, Register 0 (R0) must be written to, to ensure that the modulus value is loaded correctly. The divider select value in Register 4 (R4) is also double buffered, but only if the DB13 bit of Register 2 (R2) is set to 1.

VCO

The VCO core in the ADF4351 consists of three separate VCOs, each of which uses 16 overlapping bands, as shown in Figure 20, to allow a wide frequency range to be covered without a large VCO sensitivity (K_v) and resultant poor phase noise and spurious performance.

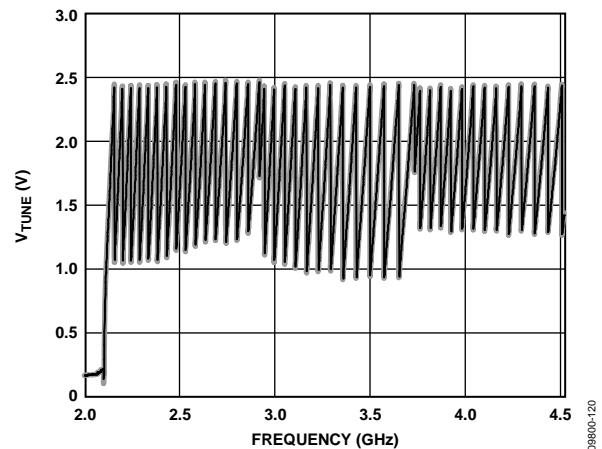

Figure 20. V_{TUNE} vs. Frequency

The correct VCO and band are selected automatically by the VCO and band select logic at power-up or whenever Register 0 (R0) is updated.

VCO and band selection take 10 PFD cycles multiplied by the value of the band select clock divider. The VCO V_{TUNE} is disconnected from the output of the loop filter and is connected to an internal reference voltage.

The R counter output is used as the clock for the band select logic. A programmable divider is provided at the R counter output to allow division by an integer from 1 to 255; the divider value is set using Bits[DB19:DB12] in Register 4 (R4). When the required PFD frequency is higher than 125 kHz, the divide ratio should be set to allow enough time for correct band selection.

Band selection takes 10 cycles of the PFD frequency, equal to 80 μ s. If faster lock times are required, Bit DB23 in Register 3 (R3) must be set to 1. This setting allows the user to select a higher band select clock frequency of up to 500 kHz, which speeds up the minimum band select time to 20 μ s. For phase adjustments and small (<1 MHz) frequency adjustments, the user can disable VCO band selection by setting Bit DB28 in Register 1 (R1) to 1. This setting selects the phase adjust feature.

After band selection, normal PLL action resumes. The nominal value of K_V is 40 MHz/V when the N divider is driven from the VCO output or from this value divided by D. D is the output divider value if the N divider is driven from the RF divider output (selected by programming Bits[DB22:DB20] in Register 4). The ADF4351 contains linearization circuitry to minimize any variation of the product of I_{CP} and K_V to keep the loop bandwidth constant.

The VCO shows variation of K_V as the V_{TUNE} varies within the band and from band to band. For wideband applications covering a wide frequency range (and changing output dividers), a value of 40 MHz/V provides the most accurate K_V because this value is closest to an average value. Figure 21 shows how K_V varies with fundamental VCO frequency, along with an average value for the frequency band. Users may prefer this figure when using narrow-band designs.

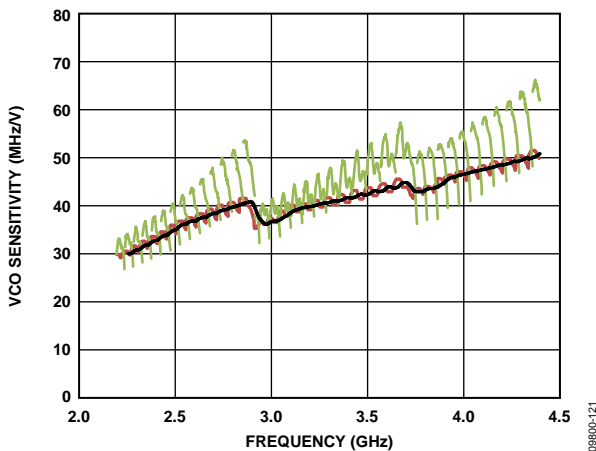

Figure 21. VCO Sensitivity (K_V) vs. Frequency

OUTPUT STAGE

The RF_{OUTA+} and RF_{OUTA-} pins of the ADF4351 are connected to the collectors of an NPN differential pair driven by buffered outputs of the VCO, as shown in Figure 22.

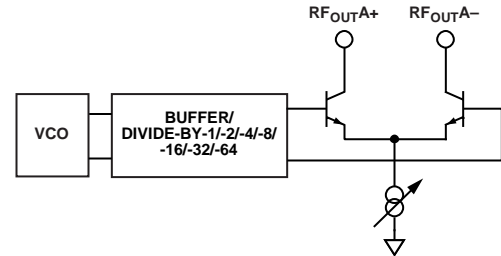

Figure 22. Output Stage

To allow the user to optimize the power dissipation vs. the output power requirements, the tail current of the differential pair is programmable using Bits[DB4:DB3] in Register 4 (R4). Four current levels can be set. These levels give output power levels of -4 dBm, -1 dBm, $+2$ dBm, and $+5$ dBm, using a 50 Ω resistor to AV_{DD} and ac coupling into a 50 Ω load. Alternatively, both outputs can be combined in a 1 + 1:1 transformer or a 180° microstrip coupler (see the Output Matching section).

If the outputs are used individually, the optimum output stage consists of a shunt inductor to V_{VCO} . The unused complementary output must be terminated with a similar circuit to the used output.

An auxiliary output stage exists on the RF_{OUTB+} and RF_{OUTB-} pins, providing a second set of differential outputs that can be used to drive another circuit. The auxiliary output stage can be used only if the primary outputs are enabled. If the auxiliary output stage is not used, it can be powered down.

Another feature of the ADF4351 is that the supply current to the RF output stage can be shut down until the part achieves lock, as measured by the digital lock detect circuitry. This feature is enabled by setting the mute till lock detect (MTLD) bit in Register 4 (R4).

REGISTER MAPS

REGISTER 0

RESERVED	16-BIT INTEGER VALUE (INT)															12-BIT FRACTIONAL VALUE (FRAC)										CONTROL BITS					
DB31	DB30	DB29	DB28	DB27	DB26	DB25	DB24	DB23	DB22	DB21	DB20	DB19	DB18	DB17	DB16	DB15	DB14	DB13	DB12	DB11	DB10	DB9	DB8	DB7	DB6	DB5	DB4	DB3	DB2	DB1	DB0
0	N16	N15	N14	N13	N12	N11	N10	N9	N8	N7	N6	N5	N4	N3	N2	N1	F12	F11	F10	F9	F8	F7	F6	F5	F4	F3	F2	F1	C3(0)	C2(0)	C1(0)

REGISTER 1

RESERVED			PHASE ADJUST		PRESCALER		12-BIT PHASE VALUE (PHASE) DBR ¹															12-BIT MODULUS VALUE (MOD) DBR ¹										CONTROL BITS		
DB31	DB30	DB29	DB28	DB27	DB26	DB25	DB24	DB23	DB22	DB21	DB20	DB19	DB18	DB17	DB16	DB15	DB14	DB13	DB12	DB11	DB10	DB9	DB8	DB7	DB6	DB5	DB4	DB3	DB2	DB1	DB0			
0	0	0	PH1	PR1	P12	P11	P10	P9	P8	P7	P6	P5	P4	P3	P2	P1	M12	M11	M10	M9	M8	M7	M6	M5	M4	M3	M2	M1	C3(0)	C2(0)	C1(1)			

REGISTER 2

RESERVED	LOW NOISE AND LOW SPUR MODES		MUXOUT			REFERENCE DOUBLER DBR ¹		RDIV2 DBR ¹		10-BIT R COUNTER DBR ¹										DOUBLE BUFFER		CHARGE PUMP CURRENT SETTING DBR ¹			LDF		LDP		PD POLARITY		POWER-DOWN		CS THREE-STATE		COUNTER RESET		CONTROL BITS		
DB31	DB30	DB29	DB28	DB27	DB26	DB25	DB24	DB23	DB22	DB21	DB20	DB19	DB18	DB17	DB16	DB15	DB14	DB13	DB12	DB11	DB10	DB9	DB8	DB7	DB6	DB5	DB4	DB3	DB2	DB1	DB0								
0	L2	L1	M3	M2	M1	RD2	RD1	R10	R9	R8	R7	R6	R5	R4	R3	R2	R1	D1	CP4	CP3	CP2	CP1	U6	U5	U4	U3	U2	U1	C3(0)	C2(1)	C1(0)								

REGISTER 3

RESERVED										BAND SELECT CLOCK MODE		ABP	CHARGE CANCEL	RESERVED			CSR		RESERVED		CLK DIV MODE		12-BIT CLOCK DIVIDER VALUE										CONTROL BITS		
DB31	DB30	DB29	DB28	DB27	DB26	DB25	DB24	DB23	DB22	DB21	DB20	DB19	DB18	DB17	DB16	DB15	DB14	DB13	DB12	DB11	DB10	DB9	DB8	DB7	DB6	DB5	DB4	DB3	DB2	DB1	DB0				
0	0	0	0	0	0	0	0	F4	F3	F2	0	0	F1	0	C2	C1	D12	D11	D10	D9	D8	D7	D6	D5	D4	D3	D2	D1	C3(0)	C2(1)	C1(1)				

REGISTER 4

RESERVED										FEEDBACK SELECT		DBB ² RF DIVIDER SELECT		8-BIT BAND SELECT CLOCK DIVIDER VALUE								VCO POWER-DOWN	MTLD	AUX OUTPUT SELECT	AUX OUTPUT ENABLE	AUX OUTPUT POWER		RF OUTPUT ENABLE	OUTPUT POWER		CONTROL BITS		
DB31	DB30	DB29	DB28	DB27	DB26	DB25	DB24	DB23	DB22	DB21	DB20	DB19	DB18	DB17	DB16	DB15	DB14	DB13	DB12	DB11	DB10	DB9	DB8	DB7	DB6	DB5	DB4	DB3	DB2	DB1	DB0		
0	0	0	0	0	0	0	0	D13	D12	D11	D10	BS8	BS7	BS6	BS5	BS4	BS3	BS2	BS1	D9	D8	D7	D6	D5	D4	D3	D2	D1	C3(1)	C2(0)	C1(0)		

REGISTER 5

RESERVED										LD PIN MODE		RESERVED	RESERVED		RESERVED										CONTROL BITS								
DB31	DB30	DB29	DB28	DB27	DB26	DB25	DB24	DB23	DB22	DB21	DB20	DB19	DB18	DB17	DB16	DB15	DB14	DB13	DB12	DB11	DB10	DB9	DB8	DB7	DB6	DB5	DB4	DB3	DB2	DB1	DB0		
0	0	0	0	0	0	0	0	D15	D14	0	1	1	0	0	0	0	0	0	0	0	0	0	0	0	0	0	0	0	0	0	C3(1)	C2(0)	C1(1)

¹DBR = DOUBLE-BUFFERED REGISTER—BUFFERED BY THE WRITE TO REGISTER 0.
²DBB = DOUBLE-BUFFERED BITS—BUFFERED BY THE WRITE TO REGISTER 0, IF AND ONLY IF DB13 OF REGISTER 2 IS HIGH.

Figure 23. Register Summary

098900-023

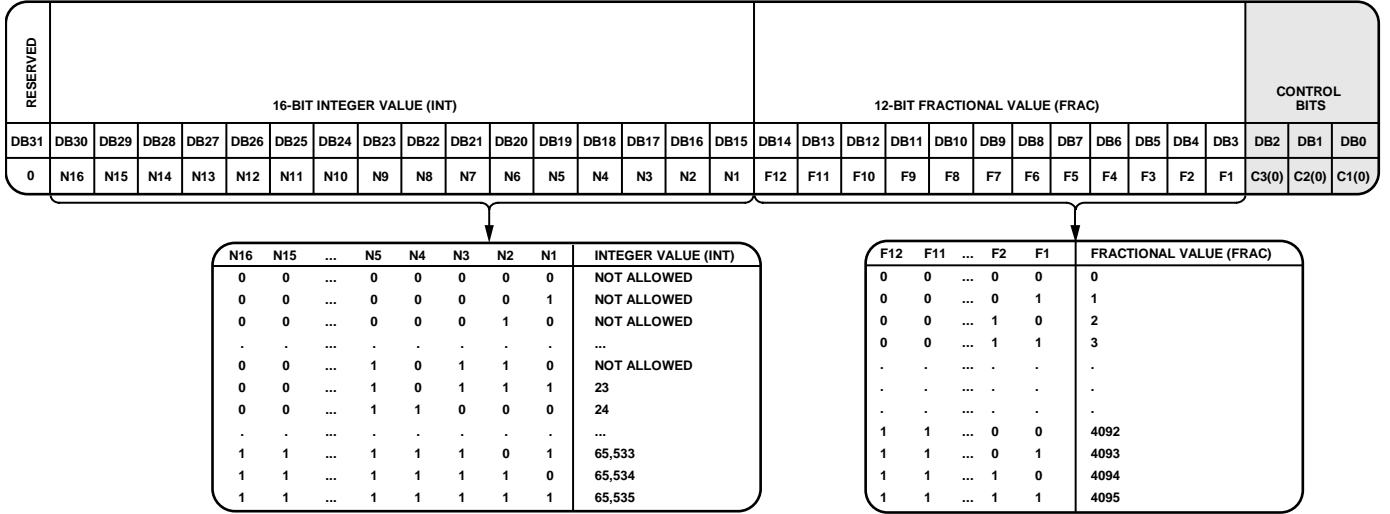

INTmin = 75 WITH PRESCALER = 8/9

Figure 24. Register 0 (R0)

09800-012

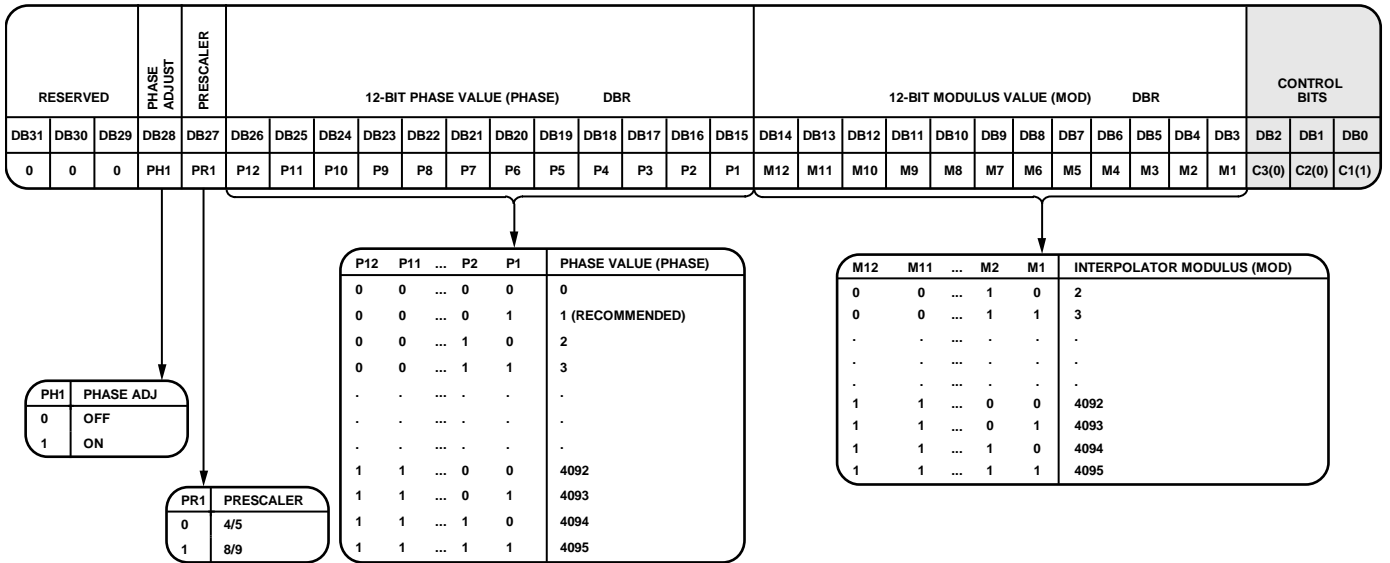

Figure 25. Register 1 (R1)

09800-013

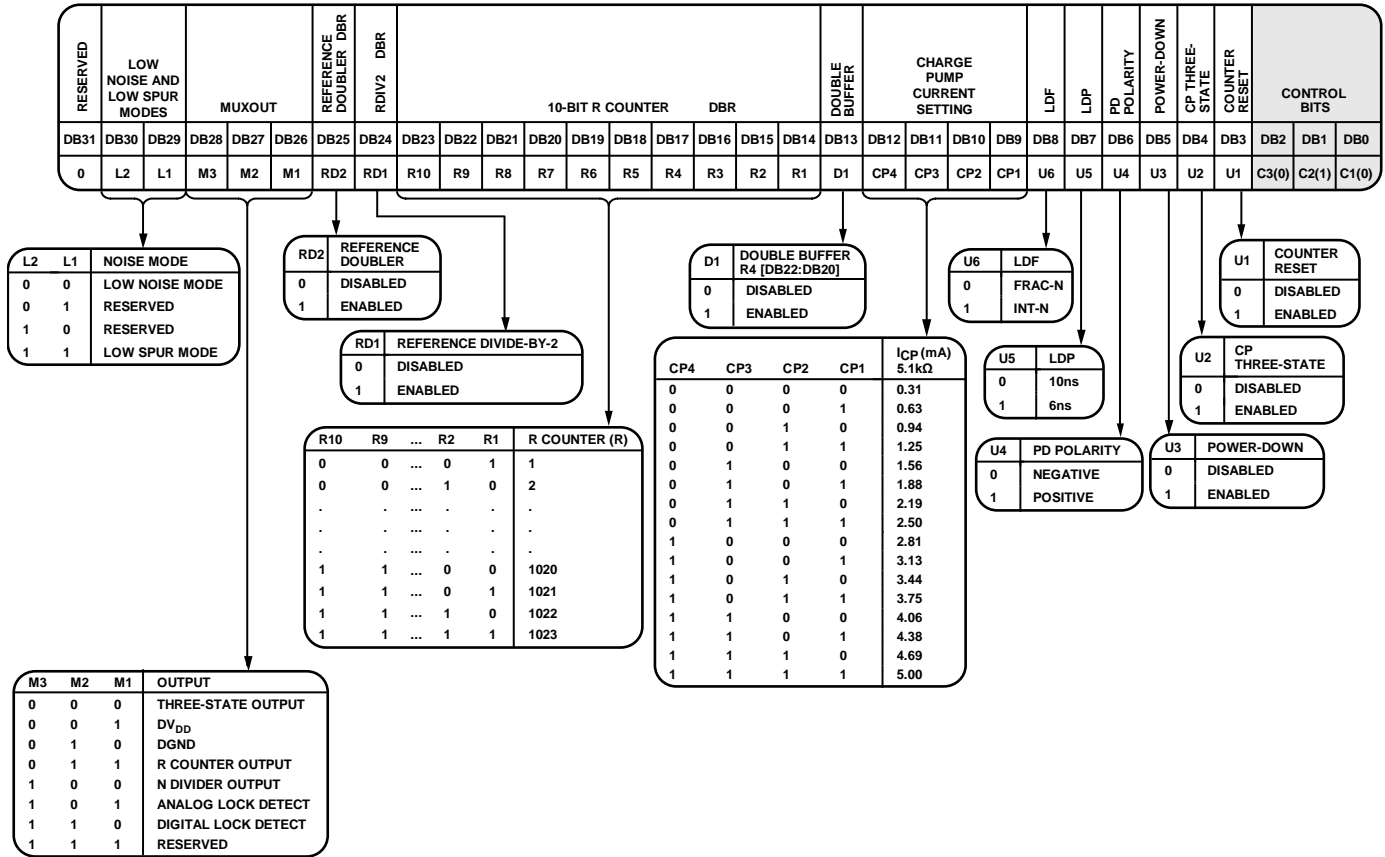

Figure 26. Register 2 (R2)

08900-014

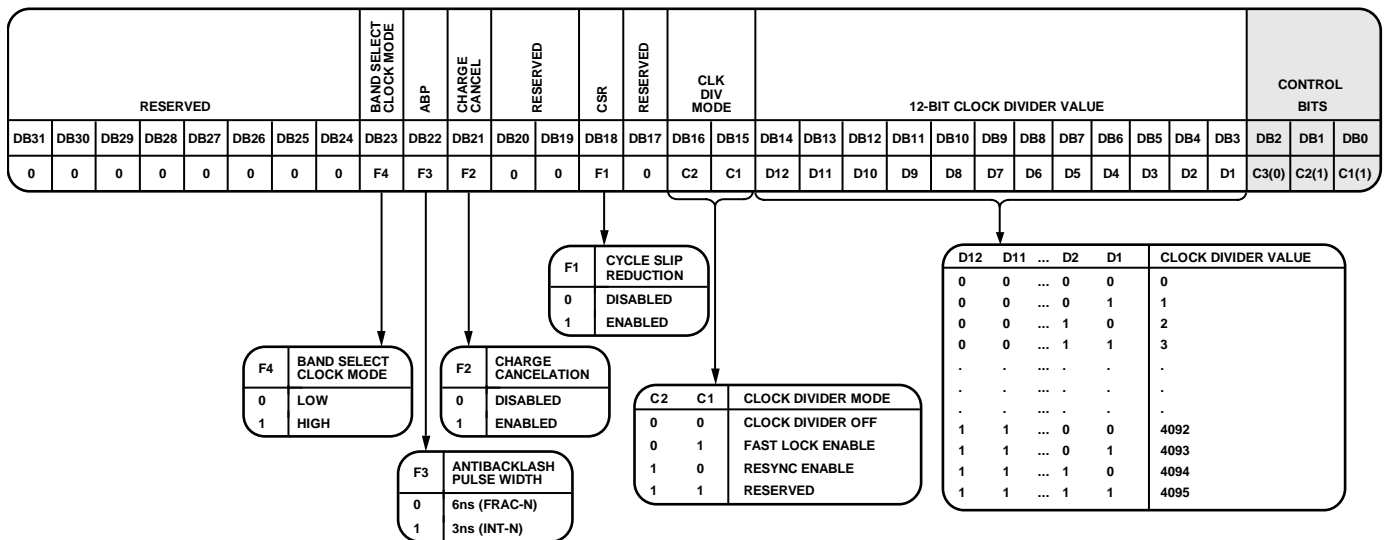

Figure 27. Register 3 (R3)

08900-015

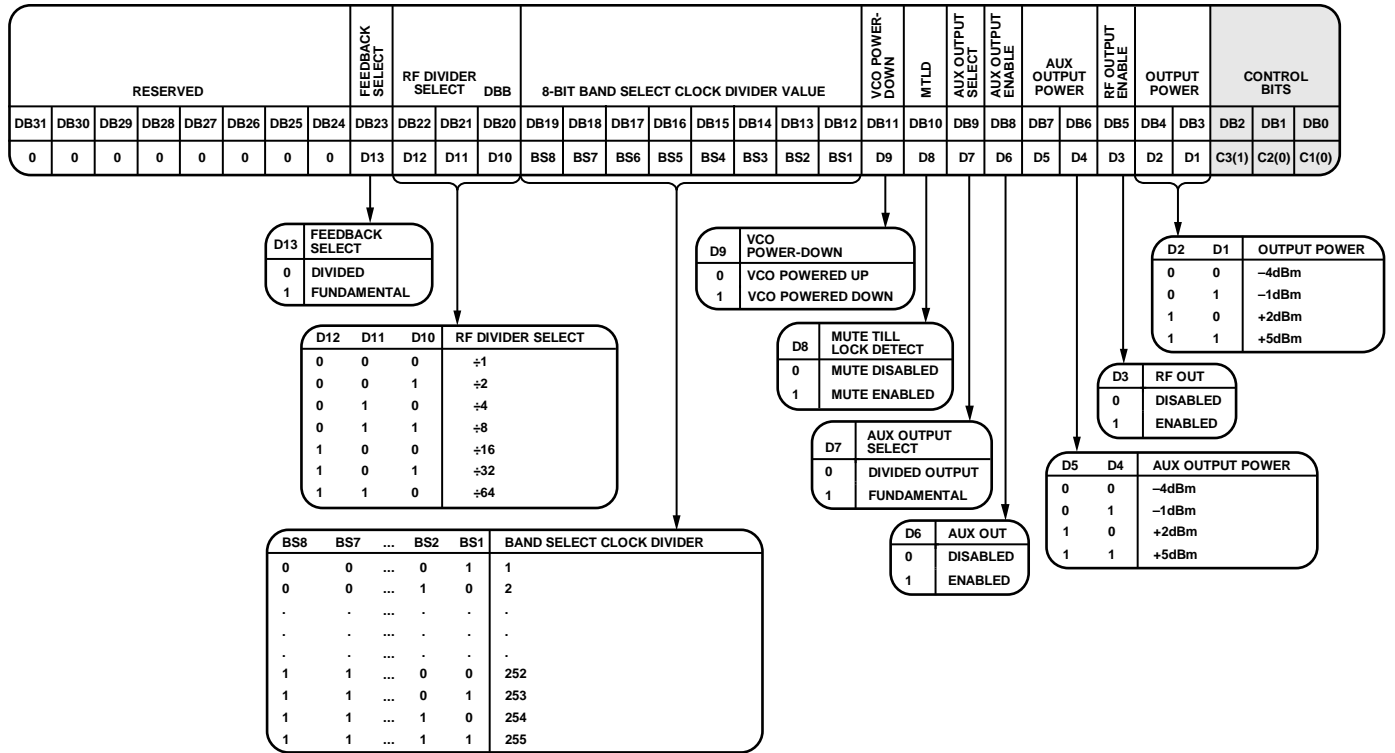

Figure 28. Register 4 (R4)

09800-016

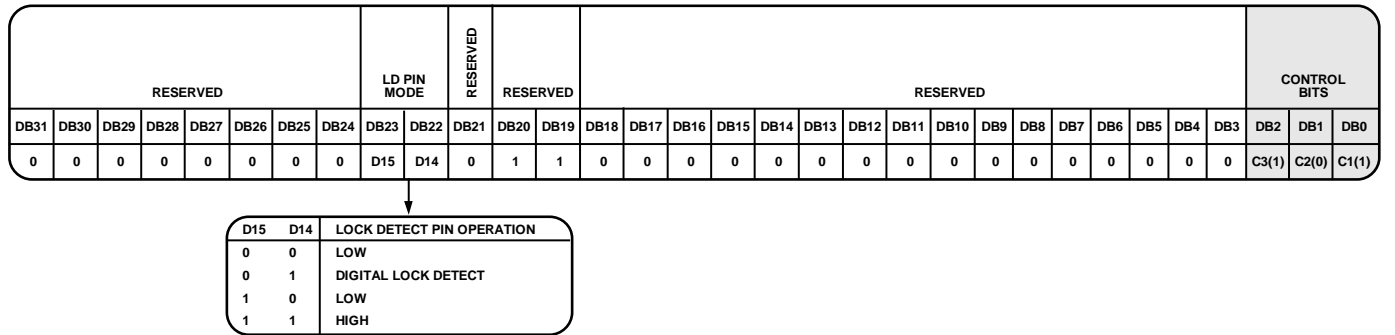

Figure 29. Register 5 (R5)

09800-017

REGISTER 0**Control Bits**

When Bits[C3:C1] are set to 000, Register 0 is programmed. Figure 24 shows the input data format for programming this register.

16-Bit Integer Value (INT)

The 16 INT bits (Bits[DB30:DB15]) set the INT value, which determines the integer part of the feedback division factor. The INT value is used in Equation 1 (see the INT, FRAC, MOD, and R Counter Relationship section). Integer values from 23 to 65,535 are allowed for the 4/5 prescaler; for the 8/9 prescaler, the minimum integer value is 75.

12-Bit Fractional Value (FRAC)

The 12 FRAC bits (Bits[DB14:DB3]) set the numerator of the fraction that is input to the Σ - Δ modulator. This fraction, along with the INT value, specifies the new frequency channel that the synthesizer locks to, as shown in the RF Synthesizer—A Worked Example section. FRAC values from 0 to (MOD – 1) cover channels over a frequency range equal to the PFD reference frequency.

REGISTER 1**Control Bits**

When Bits[C3:C1] are set to 001, Register 1 is programmed. Figure 25 shows the input data format for programming this register.

Phase Adjust

The phase adjust bit (Bit DB28) enables adjustment of the output phase of a given output frequency. When phase adjustment is enabled (Bit DB28 is set to 1), the part does not perform VCO band selection or phase resync when Register 0 is updated. When phase adjustment is disabled (Bit DB28 is set to 0), the part performs VCO band selection and phase resync (if phase resync is enabled in Register 3, Bits[DB16:DB15]) when Register 0 is updated. Disabling VCO band selection is recommended only for fixed frequency applications or for frequency deviations of <1 MHz from the originally selected frequency.

Prescaler Value

The dual-modulus prescaler ($P/P + 1$), along with the INT, FRAC, and MOD values, determines the overall division ratio from the VCO output to the PFD input. The PR1 bit (DB27) in Register 1 sets the prescaler value.

Operating at CML levels, the prescaler takes the clock from the VCO output and divides it down for the counters. The prescaler is based on a synchronous 4/5 core. When the prescaler is set to 4/5, the maximum RF frequency allowed is 3.6 GHz. Therefore, when operating the ADF4351 above 3.6 GHz, the prescaler must be set to 8/9. The prescaler limits the INT value as follows:

- Prescaler = 4/5: $N_{\text{MIN}} = 23$
- Prescaler = 8/9: $N_{\text{MIN}} = 75$

12-Bit Phase Value

Bits[DB26:DB15] control the phase word. The phase word must be less than the MOD value programmed in Register 1. The phase word is used to program the RF output phase from 0° to 360° with a resolution of 360°/MOD (see the Phase Resync section).

In most applications, the phase relationship between the RF signal and the reference is not important. In such applications, the phase value can be used to optimize the fractional and sub-fractional spur levels. For more information, see the Spur Consistency and Fractional Spur Optimization section.

If neither the phase resync nor the spurious optimization function is used, it is recommended that the phase word be set to 1.

12-Bit Modulus Value (MOD)

The 12 MOD bits (Bits[DB14:DB3]) set the fractional modulus. The fractional modulus is the ratio of the PFD frequency to the channel step resolution on the RF output. For more information, see the 12-Bit Programmable Modulus section.

REGISTER 2**Control Bits**

When Bits[C3:C1] are set to 010, Register 2 is programmed. Figure 26 shows the input data format for programming this register.

Low Noise and Low Spur Modes

The noise mode on the ADF4351 is controlled by setting Bits[DB30:DB29] in Register 2 (see Figure 26). The noise mode allows the user to optimize a design either for improved spurious performance or for improved phase noise performance.

When the low spur mode is selected, dither is enabled. Dither randomizes the fractional quantization noise so that it resembles white noise rather than spurious noise. As a result, the part is optimized for improved spurious performance. Low spur mode is normally used for fast-locking applications when the PLL closed-loop bandwidth is wide. Wide loop bandwidth is a loop bandwidth greater than 1/10 of the f_{RES} channel step resolution (f_{RES}). A wide loop filter does not attenuate the spurs to the same level as a narrow loop bandwidth.

For best noise performance, use the low noise mode option. When the low noise mode is selected, dither is disabled. This mode ensures that the charge pump operates in an optimum region for noise performance. Low noise mode is extremely useful when a narrow loop filter bandwidth is available. The synthesizer ensures extremely low noise, and the filter attenuates the spurs. Figure 10 through Figure 12 show the trade-offs in a typical W-CDMA setup for different noise and spur settings.

MUXOUT

The on-chip multiplexer is controlled by Bits[DB28:DB26] (see Figure 26). Note that N counter output must be disabled for VCO band selection to operate correctly.

Reference Doubler

Setting the DB25 bit to 0 disables the doubler and feeds the REF_{IN} signal directly into the 10-bit R counter. Setting this bit to 1 multiplies the REF_{IN} frequency by a factor of 2 before feeding it into the 10-bit R counter. When the doubler is disabled, the REF_{IN} falling edge is the active edge at the PFD input to the fractional synthesizer. When the doubler is enabled, both the rising and falling edges of REF_{IN} become active edges at the PFD input.

When the doubler is enabled and the low spur mode is selected, the in-band phase noise performance is sensitive to the REF_{IN} duty cycle. The phase noise degradation can be as much as 5 dB for REF_{IN} duty cycles outside a 45% to 55% range. The phase noise is insensitive to the REF_{IN} duty cycle in the low noise mode and when the doubler is disabled.

The maximum allowable REF_{IN} frequency when the doubler is enabled is 30 MHz.

RDIV2

Setting the DB24 bit to 1 inserts a divide-by-2 toggle flip-flop between the R counter and the PFD, which extends the maximum REF_{IN} input rate. This function allows a 50% duty cycle signal to appear at the PFD input, which is necessary for cycle slip reduction.

10-Bit R Counter

The 10-bit R counter (Bits[DB23:DB14]) allows the input reference frequency (REF_{IN}) to be divided down to produce the reference clock to the PFD. Division ratios from 1 to 1023 are allowed.

Double Buffer

The DB13 bit enables or disables double buffering of Bits[DB22:DB20] in Register 4. For information about how double buffering works, see the Program Modes section.

Charge Pump Current Setting

Bits[DB12:DB9] set the charge pump current. This value should be set to the charge pump current that the loop filter is designed with (see Figure 26).

Lock Detect Function (LDF)

The DB8 bit configures the lock detect function (LDF). The LDF controls the number of PFD cycles monitored by the lock detect circuit to ascertain whether lock has been achieved. When DB8 is set to 0, the number of PFD cycles monitored is 40. When DB8 is set to 1, the number of PFD cycles monitored is 5. It is recommended that the DB8 bit be set to 0 for fractional-N mode and to 1 for integer-N mode.

Lock Detect Precision (LDP)

The lock detect precision bit (Bit DB7) sets the comparison window in the lock detect circuit. When DB7 is set to 0, the comparison window is 10 ns; when DB7 is set to 1, the window is 6 ns. The lock detect circuit goes high when n consecutive PFD cycles are less than the comparison window value; n is set by the LDF bit (DB8). For example, with DB8 = 0 and DB7 = 0, 40 consecutive PFD cycles of 10 ns or less must occur before digital lock detect goes high.

For fractional-N applications, the recommended setting for Bits[DB8:DB7] is 00; for integer-N applications, the recommended setting for Bits[DB8:DB7] is 11.

Phase Detector Polarity

The DB6 bit sets the phase detector polarity. When a passive loop filter or a noninverting active loop filter is used, this bit should be set to 1. If an active filter with an inverting characteristic is used, this bit should be set to 0.

Power-Down (PD)

The DB5 bit provides the programmable power-down mode. Setting this bit to 1 performs a power-down. Setting this bit to 0 returns the synthesizer to normal operation. In software power-down mode, the part retains all information in its registers. The register contents are lost only if the supply voltages are removed.

When power-down is activated, the following events occur:

- Synthesizer counters are forced to their load state conditions.
- VCO is powered down.
- Charge pump is forced into three-state mode.
- Digital lock detect circuitry is reset.
- RF_{OUT} buffers are disabled.
- Input registers remain active and capable of loading and latching data.

Charge Pump Three-State

Setting the DB4 bit to 1 puts the charge pump into three-state mode. This bit should be set to 0 for normal operation.

Counter Reset

The DB3 bit is the reset bit for the R counter and the N counter of the ADF4351. When this bit is set to 1, the RF synthesizer N counter and R counter are held in reset. For normal operation, this bit should be set to 0.

REGISTER 3**Control Bits**

When Bits[C3:C1] are set to 011, Register 3 is programmed. Figure 27 shows the input data format for programming this register.

Band Select Clock Mode

Setting the DB23 bit to 1 selects a faster logic sequence of band selection, which is suitable for high PFD frequencies and is necessary for fast lock applications. Setting the DB23 bit to 0 is recommended for low PFD (<125 kHz) values. For the faster band select logic modes (DB23 set to 1), the value of the band select clock divider must be less than or equal to 254.

Antibacklash Pulse Width (ABP)

Bit DB22 sets the PFD antibacklash pulse width. When Bit DB22 is set to 0, the PFD antibacklash pulse width is 6 ns. This setting is recommended for fractional-N use. When Bit DB22 is set to 1, the PFD antibacklash pulse width is 3 ns, which results in phase noise and spur improvements in integer-N operation. For fractional-N operation, the 3 ns setting is not recommended.

Charge Cancellation

Setting the DB21 bit to 1 enables charge pump charge cancellation. This has the effect of reducing PFD spurs in integer-N mode. In fractional-N mode, this bit should be set to 0.

CSR Enable

Setting the DB18 bit to 1 enables cycle slip reduction. CSR is a method for improving lock times. Note that the signal at the phase frequency detector (PFD) must have a 50% duty cycle for cycle slip reduction to work. The charge pump current setting must also be set to a minimum. For more information, see the Cycle Slip Reduction for Faster Lock Times section.

Clock Divider Mode

Bits[DB16:DB15] must be set to 10 to activate phase resync (see the Phase Resync section). These bits must be set to 01 to activate fast lock (see the Fast Lock Timer and Register Sequences section). Setting Bits[DB16:DB15] to 00 disables the clock divider (see Figure 27).

12-Bit Clock Divider Value

Bits[DB14:DB3] set the 12-bit clock divider value. This value is the timeout counter for activation of phase resync (see the Phase Resync section). The clock divider value also sets the timeout counter for fast lock (see the Fast Lock Timer and Register Sequences section).

REGISTER 4**Control Bits**

When Bits[C3:C1] are set to 100, Register 4 is programmed. Figure 28 shows the input data format for programming this register.

Feedback Select

The DB23 bit selects the feedback from the VCO output to the N counter. When this bit is set to 1, the signal is taken directly from the VCO. When this bit is set to 0, the signal is taken from the output of the output dividers. The dividers enable coverage of the wide frequency band (34.375 MHz to 4.4 GHz). When the dividers are enabled and the feedback signal is taken from the output, the RF output signals of two separately configured PLLs are in phase. This is useful in some applications where the positive interference of signals is required to increase the power.

RF Divider Select

Bits[DB22:DB20] select the value of the RF output divider (see Figure 28).

Band Select Clock Divider Value

Bits[DB19:DB12] set a divider for the band select logic clock input. By default, the output of the R counter is the value used to clock the band select logic, but, if this value is too high (>125 kHz), a divider can be switched on to divide the R counter output to a smaller value (see Figure 28).

VCO Power-Down

Setting the DB11 bit to 0 powers the VCO up; setting this bit to 1 powers the VCO down.

Mute Till Lock Detect (MTLD)

When the DB10 bit is set to 1, the supply current to the RF output stage is shut down until the part achieves lock, as measured by the digital lock detect circuitry.

AUX Output Select

The DB9 bit sets the auxiliary RF output. If DB9 is set to 0, the auxiliary RF output is the output of the RF dividers; if DB9 is set to 1, the auxiliary RF output is the fundamental VCO frequency.

AUX Output Enable

The DB8 bit enables or disables the auxiliary RF output. If DB8 is set to 0, the auxiliary RF output is disabled; if DB8 is set to 1, the auxiliary RF output is enabled.

AUX Output Power

Bits[DB7:DB6] set the value of the auxiliary RF output power level (see Figure 28).

RF Output Enable

The DB5 bit enables or disables the primary RF output. If DB5 is set to 0, the primary RF output is disabled; if DB5 is set to 1, the primary RF output is enabled.

Output Power

Bits[DB4:DB3] set the value of the primary RF output power level (see Figure 28).

REGISTER 5**Control Bits**

When Bits[C3:C1] are set to 101, Register 5 is programmed. Figure 29 shows the input data format for programming this register.

Lock Detect Pin Operation

Bits[DB23:DB22] set the operation of the lock detect (LD) pin (see Figure 29).

REGISTER INITIALIZATION SEQUENCE

At initial power-up, after the correct application of voltages to the supply pins, the ADF4351 registers should be started in the following sequence:

1. Register 5
2. Register 4
3. Register 3
4. Register 2
5. Register 1
6. Register 0

RF SYNTHESIZER—A WORKED EXAMPLE

The following equations are used to program the ADF4351 synthesizer:

$$RF_{OUT} = [INT + (FRAC/MOD)] \times (f_{PFD}/RF \text{ Divider}) \quad (3)$$

where:

RF_{OUT} is the RF frequency output.

INT is the integer division factor.

$FRAC$ is the numerator of the fractional division (0 to $MOD - 1$).

MOD is the preset fractional modulus (2 to 4095).

$RF \text{ Divider}$ is the output divider that divides down the VCO frequency.

$$f_{PFD} = REF_{IN} \times [(1 + D)/(R \times (1 + T))] \quad (4)$$

where:

REF_{IN} is the reference frequency input.

D is the RF REF_{IN} doubler bit (0 or 1).

R is the RF reference division factor (1 to 1023).

T is the reference divide-by-2 bit (0 or 1).

As an example, a UMTS system requires a 2112.6 MHz RF frequency output (RF_{OUT}); a 10 MHz reference frequency input (REF_{IN}) is available and a 200 kHz channel resolution (f_{RESOUT}) is required on the RF output.

Note that the ADF4351 VCO operates in the frequency range of 2.2 GHz to 4.4 GHz. Therefore, the RF divider of 2 should be used (VCO frequency = 4225.2 MHz, $RF_{OUT} = \text{VCO frequency} / \text{RF divider} = 4225.2 \text{ MHz} / 2 = 2112.6 \text{ MHz}$).

It is also important where the loop is closed. In this example, the loop is closed before the output divider (see Figure 30).

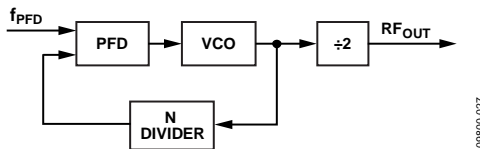

Figure 30. Loop Closed Before Output Divider

Channel resolution (f_{RESOUT}) of 200 kHz is required at the output of the RF divider. Therefore, the channel resolution at the output of the VCO (f_{RES}) needs to be $2 \times f_{RESOUT}$, that is, 400 kHz.

$$MOD = REF_{IN} / f_{RES}$$

$$MOD = 10 \text{ MHz} / 400 \text{ kHz} = 25$$

From Equation 4,

$$f_{PFD} = [10 \text{ MHz} \times (1 + 0)/1] = 10 \text{ MHz} \quad (5)$$

$$2112.6 \text{ MHz} = 10 \text{ MHz} \times [(INT + (FRAC/25))/2] \quad (6)$$

where:

$INT = 422$.

$FRAC = 13$.

REFERENCE DOUBLER AND REFERENCE DIVIDER

The on-chip reference doubler allows the input reference signal to be doubled. Doubling the reference signal doubles the PFD comparison frequency, which improves the noise performance of the system. Doubling the PFD frequency usually improves noise performance by 3 dB. Note that in fractional-N mode, the PFD cannot operate above 32 MHz due to a limitation in the speed of the Σ - Δ circuit of the N divider. For integer-N applications, the PFD can operate up to 90 MHz.

The reference divide-by-2 divides the reference signal by 2, resulting in a 50% duty cycle PFD frequency. This is necessary for the correct operation of the cycle slip reduction (CSR) function. For more information, see the Cycle Slip Reduction for Faster Lock Times section.

12-BIT PROGRAMMABLE MODULUS

The choice of modulus (MOD) depends on the reference signal (REF_{IN}) available and the channel resolution (f_{RES}) required at the RF output. For example, a GSM system with 13 MHz REF_{IN} sets the modulus to 65. This means that the RF output resolution (f_{RES}) is the 200 kHz (13 MHz/65) necessary for GSM. With dither off, the fractional spur interval depends on the selected modulus values (see Table 7).

Unlike most other fractional-N PLLs, the ADF4351 allows the user to program the modulus over a 12-bit range. When combined with the reference doubler and the 10-bit R counter, the 12-bit modulus allows the user to set up the part in many different configurations for the application.

For example, consider an application that requires a 1.75 GHz RF frequency output with a 200 kHz channel step resolution. The system has a 13 MHz reference signal.

One possible setup is to feed the 13 MHz reference signal directly into the PFD and to program the modulus to divide by 65. This results in the required 200 kHz resolution.

Another possible setup is to use the reference doubler to create 26 MHz from the 13 MHz input signal. The 26 MHz is then fed into the PFD, and the modulus is programmed to divide by 130. This setup also results in 200 kHz resolution but offers superior phase noise performance over the first setup.

The programmable modulus is also very useful for multi-standard applications. For example, if a dual-mode phone requires PDC and GSM 1800 standards, the programmable modulus is of great benefit.

PDC requires 25 kHz channel step resolution, whereas GSM 1800 requires 200 kHz channel step resolution. A 13 MHz reference signal can be fed directly to the PFD, and the modulus can be programmed to 520 when in PDC mode (13 MHz/520 = 25 kHz). The modulus must be reprogrammed to 65 for GSM 1800 operation (13 MHz/65 = 200 kHz).

It is important that the PFD frequency remain constant (in this example, 13 MHz). This allows the user to design one loop filter for both setups without encountering stability issues. Note that the ratio of the RF frequency to the PFD frequency principally affects the loop filter design, not the actual channel spacing.

CYCLE SLIP REDUCTION FOR FASTER LOCK TIMES

As described in the Low Noise and Low Spur Modes section, the ADF4351 contains a number of features that allow optimization for noise performance. However, in fast-locking applications, the loop bandwidth generally needs to be wide and, therefore, the filter does not provide much attenuation of the spurs. If the cycle slip reduction feature is enabled, the narrow loop bandwidth is maintained for spur attenuation, but faster lock times are still possible.

Cycle Slips

Cycle slips occur in integer-N/fractional-N synthesizers when the loop bandwidth is narrow compared to the PFD frequency. The phase error at the PFD inputs accumulates too fast for the PLL to correct, and the charge pump temporarily pumps in the wrong direction. This slows down the lock time dramatically. The ADF4351 contains a cycle slip reduction feature that extends the linear range of the PFD, allowing faster lock times without modifications to the loop filter circuitry.

When the circuitry detects that a cycle slip is about to occur, it turns on an extra charge pump current cell. This cell outputs a constant current to the loop filter or removes a constant current from the loop filter (depending on whether the VCO tuning voltage needs to increase or decrease to acquire the new frequency). The effect is that the linear range of the PFD is increased. Loop stability is maintained because the current is constant and is not a pulsed current.

If the phase error increases again to a point where another cycle slip is likely, the ADF4351 turns on another charge pump cell. This continues until the ADF4351 detects that the VCO frequency has exceeded the desired frequency. The extra charge pump cells are turned off one by one until all the extra charge pump cells are disabled and the frequency settles to the original loop filter bandwidth.

Up to seven extra charge pump cells can be turned on. In most applications, seven cells are enough to eliminate cycle slips altogether, providing much faster lock times.

Setting Bit DB18 in Register 3 to 1 enables cycle slip reduction. Note that the PFD requires a 45% to 55% duty cycle for CSR to operate correctly. If the REF_{IN} frequency does not have a suitable duty cycle, enabling the RDIV2 mode (Bit DB24 in Register 2) ensures that the input to the PFD has a 50% duty cycle.

SPURIOUS OPTIMIZATION AND FAST LOCK

Narrow loop bandwidths can filter unwanted spurious signals, but these bandwidths usually have a long lock time. A wider loop bandwidth achieves faster lock times but may lead to increased spurious signals inside the loop bandwidth.

The fast lock feature can achieve the same fast lock time as the wider bandwidth but with the advantage of a narrow final loop bandwidth to keep spurs low.

FAST LOCK TIMER AND REGISTER SEQUENCES

If the fast lock mode is used, a timer value must be loaded into the PLL to determine the duration of the wide bandwidth mode.

When Bits[DB16:DB15] in Register 3 are set to 01 (fast lock enable), the timer value is loaded by the 12-bit clock divider value (Bits[DB14:DB3] in Register 3). The following sequence must be programmed to use fast lock:

1. Start the initialization sequence (see the Register Initialization Sequence section). This sequence occurs only once after powering up the part.
2. Load Register 3 by setting Bits[DB16:DB15] to 01 and by setting the selected fast lock timer value (Bits[DB14:DB3]). The duration that the PLL remains in wide bandwidth mode is equal to the fast lock timer/ f_{PFD} .

FAST LOCK EXAMPLE

If a PLL has a reference frequency of 13 MHz, f_{PFD} of 13 MHz, and a required lock time of 60 μs , the PLL is set to wide bandwidth mode for 20 μs . This example assumes a modulus of 65 for channel spacing of 200 kHz. The VCO calibration time of 20 μs must also be taken into account (achieved by programming the higher band select clock mode using Bit DB23 of Register 3).

If the time set for the PLL lock time in wide bandwidth mode is 20 μs , then

$$\text{Fast Lock Timer Value} = (\text{VCO Band Select Time} + \text{PLL Lock Time in Wide Bandwidth}) \times f_{\text{PFD}} / \text{MOD}$$

$$\text{Fast Lock Timer Value} = (20 \mu\text{s} + 20 \mu\text{s}) \times 13 \text{ MHz} / 65 = 8$$

Therefore, a value of 8 must be loaded into the clock divider value in Register 3 (see Step 2 in the Fast Lock Timer and Register Sequences section).

FAST LOCK LOOP FILTER TOPOLOGY

To use fast lock mode, the damping resistor in the loop filter is reduced to one-fourth its value while in wide bandwidth mode. To achieve the wider loop filter bandwidth, the charge pump current increases by a factor of 16; to maintain loop stability, the damping resistor must be reduced by a factor of one-fourth. To enable fast lock, the SW pin is shorted to the AGND pin by setting Bits[DB16:DB15] in Register 3 to 01. The following two topologies are available:

- The damping resistor (R1) is divided into two values (R1 and R1A) that have a ratio of 1:3 (see Figure 31).
- An extra resistor (R1A) is connected directly from SW, as shown in Figure 32. The extra resistor is calculated such that the parallel combination of the extra resistor and the damping resistor (R1) is reduced to one-fourth the original value of R1 (see Figure 32).

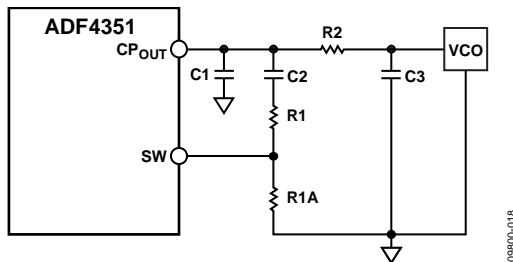

Figure 31. Fast Lock Loop Filter Topology 1

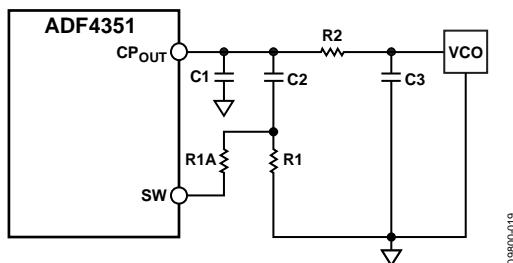

Figure 32. Fast Lock Loop Filter Topology 2

SPUR MECHANISMS

This section describes the three different spur mechanisms that arise with a fractional-N synthesizer and how to minimize them in the ADF4351.

Fractional Spurs

The fractional interpolator in the ADF4351 is a third-order Σ - Δ modulator with a modulus (MOD) that is programmable to any integer value from 2 to 4095. In low spur mode (dither on), the minimum allowable value of MOD is 50. The Σ - Δ modulator is clocked at the PFD reference rate (f_{PFD}), which allows PLL output frequencies to be synthesized at a channel step resolution of $f_{\text{PFD}}/\text{MOD}$.

In low noise mode (dither off), the quantization noise from the Σ - Δ modulator appears as fractional spurs. The interval between spurs is f_{PFD}/L , where L is the repeat length of the code sequence in the digital Σ - Δ modulator. For the third-order Σ - Δ modulator used in the ADF4351, the repeat length depends on the value of MOD (see Table 7).

Table 7. Fractional Spurs with Dither Off (Low Noise Mode)

MOD Value (Dither Off)	Repeat Length	Spur Interval
MOD is divisible by 2, but not by 3	$2 \times \text{MOD}$	Channel step/2
MOD is divisible by 3, but not by 2	$3 \times \text{MOD}$	Channel step/3
MOD is divisible by 6	$6 \times \text{MOD}$	Channel step/6
MOD is not divisible by 2, 3, or 6	MOD	Channel step

In low spur mode (dither on), the repeat length is extended to 2^{21} cycles, regardless of the value of MOD, which makes the quantization error spectrum look like broadband noise. This may degrade the in-band phase noise at the PLL output by as much as 10 dB. For lowest noise, dither off is a better choice, particularly when the final loop bandwidth is low enough to attenuate even the lowest frequency fractional spur.

Integer Boundary Spurs

Another mechanism for fractional spur creation is the interactions between the RF VCO frequency and the reference frequency. When these frequencies are not integer related (the purpose of a fractional-N synthesizer), spur sidebands appear on the VCO output spectrum at an offset frequency that corresponds to the beat note, or difference frequency, between an integer multiple of the reference and the VCO frequency. These spurs are attenuated by the loop filter and are more noticeable on channels close to integer multiples of the reference, where the difference frequency can be inside the loop bandwidth (thus the name integer boundary spurs).

Reference Spurs

Reference spurs are generally not a problem in fractional-N synthesizers because the reference offset is far outside the loop bandwidth. However, any reference feedthrough mechanism that bypasses the loop may cause a problem. Feedthrough of low levels of on-chip reference switching noise, coupling to the VCO, can result in reference spur levels as high as -80 dBc. The PCB layout must ensure adequate isolation between VCO circuitry and the input reference to avoid a possible feedthrough path on the board.

SPUR CONSISTENCY AND FRACTIONAL SPUR OPTIMIZATION

With dither off, the fractional spur pattern due to the quantization noise of the Σ - Δ modulator also depends on the particular phase word with which the modulator is seeded.

The phase word can be varied to optimize the fractional and subfractional spur levels on any particular frequency. Thus, a lookup table of phase values corresponding to each frequency can be created for use when programming the ADF4351.

If a lookup table is not used, keep the phase word at a constant value to ensure consistent spur levels on any particular frequency.

PHASE RESYNC

The output of a fractional-N PLL can settle to any one of the MOD phase offsets with respect to the input reference, where MOD is the fractional modulus. The phase resync feature of the ADF4351 produces a consistent output phase offset with respect to the input reference. This phase offset is necessary in applications where the output phase and frequency are important, such as digital beamforming. See the Phase Programmability section to program a specific RF output phase when using phase resync.

Phase resync is enabled by setting Bits[DB16:DB15] in Register 3 to 10. When phase resync is enabled, an internal timer generates sync signals at intervals of t_{SYNC} given by the following formula:

$$t_{\text{SYNC}} = \text{CLK_DIV_VALUE} \times \text{MOD} \times t_{\text{PFD}}$$

where:

CLK_DIV_VALUE is the decimal value programmed in Bits[DB14:DB3] of Register 3. This value can be any integer from 1 to 4095.

MOD is the modulus value programmed in Bits[DB14:DB3] of Register 1 (R1).

t_{PFD} is the PFD reference period.

When a new frequency is programmed, the second sync pulse after the LE rising edge is used to resynchronize the output phase to the reference. The t_{SYNC} time must be programmed to a value that is at least as long as the worst-case lock time. This guarantees that the phase resync occurs after the last cycle slip in the PLL settling transient.

In the example shown in Figure 33, the PFD reference is 25 MHz and MOD = 125 for a 200 kHz channel spacing. t_{SYNC} is set to 400 μs by programming CLK_DIV_VALUE = 80.

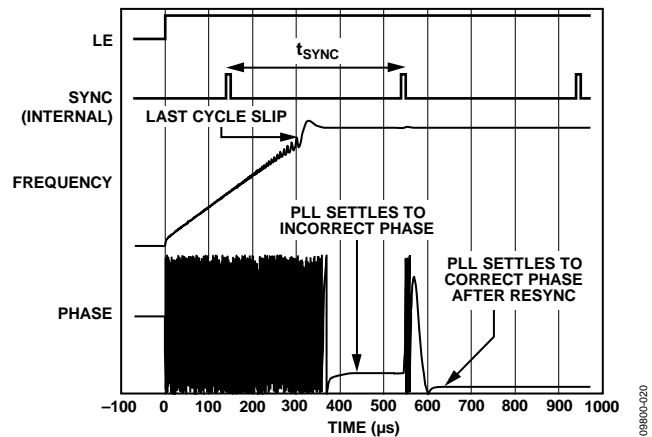

Figure 33. Phase Resync Example

Phase Programmability

The phase word in Register 1 controls the RF output phase. As this word is swept from 0 to MOD, the RF output phase sweeps over a 360° range in steps of 360°/MOD. In many applications, it is advisable to disable VCO band selection by setting Bit DB28 in Register 1 (R1) to 1. This setting selects the phase adjust feature.

High PFD Frequencies

VCO band selection is required to ensure that the correct VCO band is chosen for the relevant frequency. VCO band selection can operate with PFD frequencies up to 45 MHz using the high VCO band select mode (set Bit DB23 in Register 3 to 1).

For PFD frequencies higher than 45 MHz, it is recommended that the user perform the following steps:

1. Program the desired VCO frequency with phase adjustment disabled (set Bit DB28 in Register 1 to 0). Ensure that the PFD frequency is less than 45 MHz.
2. After the correct frequency is achieved, enable phase adjustment (set Bit DB28 in Register 1 to 1).
3. PFD frequencies higher than 32 MHz are permissible only with integer-N applications; therefore, set the antbacklash pulse width to 3 ns (set Bit DB22 in Register 3 to 1).
4. Using the desired PFD frequency, program the appropriate values for the reference R and feedback N counters.

Using this procedure, the lowest rms in-band phase noise can be achieved.

APPLICATIONS INFORMATION

DIRECT CONVERSION MODULATOR

Direct conversion architectures are increasingly being used to implement base station transmitters. Figure 34 shows how Analog Devices, Inc., parts can be used to implement such a system.

Figure 34 shows the AD9788 TxDAC[®] used with the ADL5375. The use of dual integrated DACs, such as the AD9788 with its specified $\pm 2\%$ FSR and $\pm 0.001\%$ FSR gain and offset characteristics, ensures minimum error contribution (over temperature) from this portion of the signal chain.

The local oscillator (LO) is implemented using the ADF4351. The low-pass filter was designed using ADIsimPLL[™] for a channel spacing of 200 kHz and a closed-loop bandwidth of 35 kHz.

The LO ports of the ADL5375 can be driven differentially from the complementary RF_{OUTA±} outputs of the ADF4351. This setup provides better performance than a single-ended LO driver and eliminates the use of a balun to convert from a single-ended LO input to the more desirable differential LO input for the ADL5375. The typical rms phase noise (100 Hz to 5 MHz) of the LO in this configuration is 0.61° rms.

The ADL5375 accepts LO drive levels from -6 dBm to +6 dBm. The optimum LO power can be software programmed on the ADF4351, which allows levels from -4 dBm to +5 dBm from each output.

The RF output is designed to drive a 50 Ω load, but it must be ac-coupled, as shown in Figure 34. If the I and Q inputs are driven in quadrature by 2 V p-p signals, the resulting output power from the ADL5375 modulator is approximately 2 dBm.

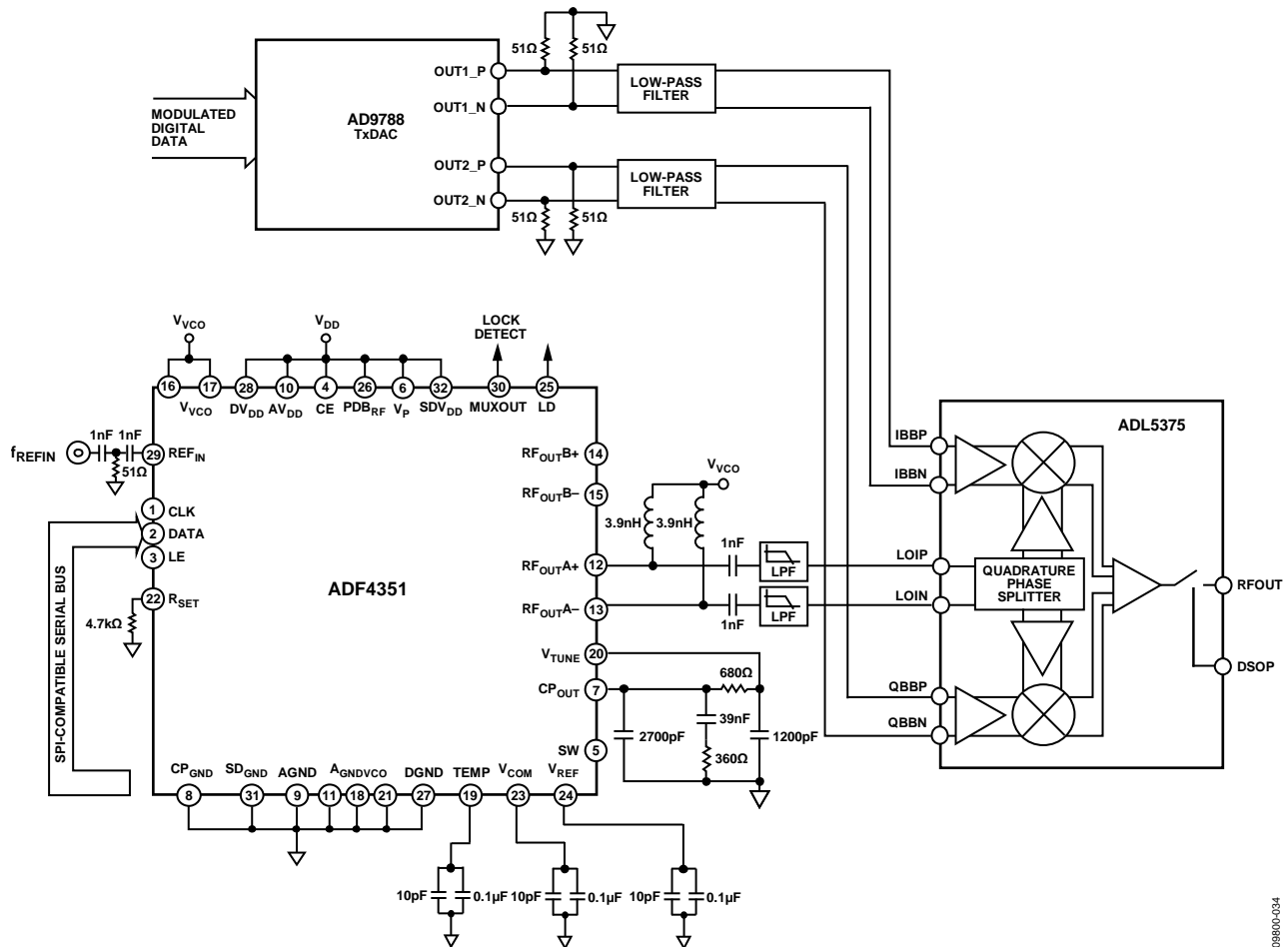

Figure 34. Direct Conversion Modulator

INTERFACING TO THE ADuC70xx AND THE ADSP-BF527

The ADF4351 has a simple SPI-compatible serial interface for writing to the device. The CLK, DATA, and LE pins control the data transfer. When LE goes high, the 32 bits that were clocked into the appropriate register on each rising edge of CLK are transferred to the appropriate latch. See Figure 2 for the timing diagram and Table 6 for the register address table.

ADuC70xx Interface

Figure 35 shows the interface between the ADF4351 and the ADuC70xx family of analog microcontrollers. The ADuC70xx family is based on an AMR7 core, but the same interface can be used with any 8051-based microcontroller.

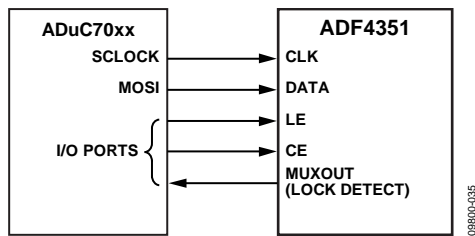

Figure 35. ADuC70xx to ADF4351 Interface

The microcontroller is set up for SPI master mode with CPHA = 0. To initiate the operation, the I/O port driving LE is brought low. Each latch of the ADF4351 needs a 32-bit word, which is accomplished by writing four 8-bit bytes from the microcontroller to the device. After the fourth byte is written, the LE input should be brought high to complete the transfer.

When power is first applied to the ADF4351, the part requires six writes (one each to R5, R4, R3, R2, R1, and R0) for the output to become active.

I/O port lines on the microcontroller are also used to control the power-down input (CE) and to detect lock (MUXOUT configured as lock detect and polled by the port input).

When operating in the mode described, the maximum SPI transfer rate of the ADuC70xx is 20 Mbps. This means that the maximum rate at which the output frequency can be changed is 833 kHz. If using a faster SPI clock, make sure that the SPI timing requirements listed in Table 2 are adhered to.

ADSP-BF527 Interface

Figure 36 shows the interface between the ADF4351 and the Blackfin® ADSP-BF527 digital signal processor (DSP). The ADF4351 needs a 32-bit serial word for each latch write. The easiest way to accomplish this using the Blackfin family is to use the autobuffered transmit mode of operation with alternate framing. This mode provides a means for transmitting an entire block of serial data before an interrupt is generated.

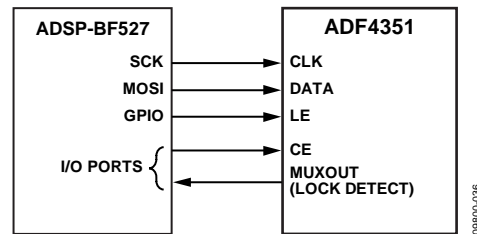

Figure 36. ADSP-BF527 to ADF4351 Interface

Set up the word length for eight bits and use four memory locations for each 32-bit word. To program each 32-bit latch, store the four 8-bit bytes, enable the autobuffered mode, and write to the transmit register of the DSP. This last operation initiates the autobuffer transfer. Make sure that the SPI timing requirements listed in Table 2 are adhered to.

PCB DESIGN GUIDELINES FOR A CHIP SCALE PACKAGE

The lands on the chip scale package (CP-32-2) are rectangular. The PCB pad for these lands must be 0.1 mm longer than the package land length and 0.05 mm wider than the package land width. Each land must be centered on the pad to ensure that the solder joint size is maximized.

The bottom of the chip scale package has a central exposed thermal pad. The thermal pad on the PCB must be at least as large as the exposed pad. On the PCB, there must be a minimum clearance of 0.25 mm between the thermal pad and the inner edges of the pad pattern to ensure that shorting is avoided.

Thermal vias can be used on the PCB thermal pad to improve the thermal performance of the package. If vias are used, they must be incorporated into the thermal pad at 1.2 mm pitch grid. The via diameter must be between 0.3 mm and 0.33 mm, and the via barrel must be plated with 1 oz. of copper to plug the via.

OUTPUT MATCHING

For optimum operation, the output of the ADF4351 can be matched in a number of ways; the most basic method is to connect a 50 Ω resistor to V_{VCO}. A dc bypass capacitor of 100 pF is connected in series, as shown in Figure 37. Because the resistor is not frequency dependent, this method provides a good broadband match. When connected to a 50 Ω load, this circuit typically gives a differential output power equal to the value selected by Bits[DB4:DB3] in Register 4 (R4).

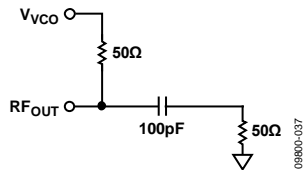

Figure 37. Simple Output Stage

A better solution is to use a shunt inductor (acting as an RF choke) to V_{VCO}. This solution gives a better match and, therefore, more output power.

Experiments have shown that the circuit shown in Figure 38 provides an excellent match to 50 Ω for the W-CDMA UMTS Band 1 (2110 MHz to 2170 MHz). The maximum output power in this case is approximately 5 dBm. Both single-ended architectures can be examined using the EVAL-ADF4351EB1Z evaluation board.

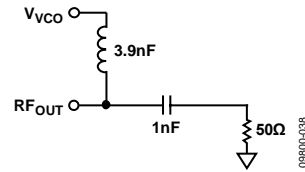

Figure 38. Optimum Output Stage

If differential outputs are not needed, the unused output can be terminated, or both outputs can be combined using a balun.

A balun using discrete inductors and capacitors can be implemented with the architecture shown in Figure 39. The LC balun comprises Component L1 and Component C1. L2 provides a dc path for RF_{OUTA+}-, and Capacitor C2 is used for dc blocking.

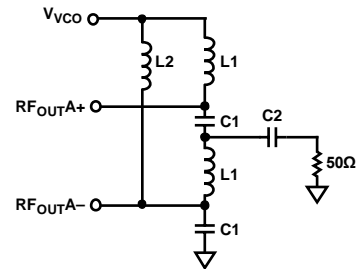
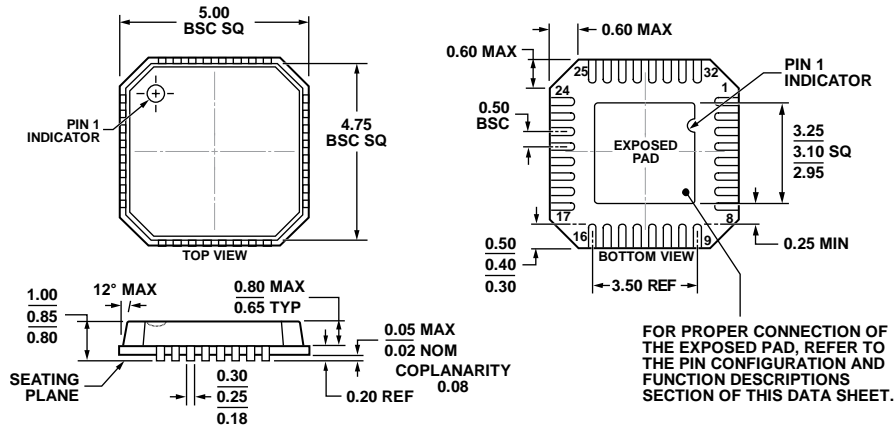

Figure 39. LC Balun for the ADF4351

Table 8. LC Balun Components

Frequency Range (MHz)	Inductor L1 (nH)	Capacitor C1 (pF)	RF Choke Inductor L2 (nH)	DC Blocking Capacitor C2 (pF)	Measured Output Power (dBm)
137 to 300	100	10	390	1000	9
300 to 460	51	5.6	180	120	10
400 to 600	30	5.6	120	120	10
600 to 900	18	4	68	120	10
860 to 1240	12	2.2	39	10	9
1200 to 1600	5.6	1.2	15	10	9
1600 to 3600	3.3	0.7	10	10	8
2800 to 3800	2.2	0.5	10	10	8

OUTLINE DIMENSIONS



COMPLIANT TO JEDEC STANDARDS MO-220-VHHD-2

Figure 40. 32-Lead Lead Frame Chip Scale Package [LFCSP_VQ]
 5 mm × 5 mm Body, Very Thin Quad
 (CP-32-2)
 Dimensions shown in millimeters

03-28-2012-A

ORDERING GUIDE

Model ¹	Temperature Range	Package Description	Package Option
ADF4351BCPZ	-40°C to +85°C	32-Lead Lead Frame Chip Scale Package [LFCSP_VQ]	CP-32-2
ADF4351BCPZ-RL7	-40°C to +85°C	32-Lead Lead Frame Chip Scale Package [LFCSP_VQ]	CP-32-2
EVAL-ADF4351EB1Z		Evaluation Board	

¹ Z = RoHS Compliant Part.