

Standard Rectifier Module

$$V_{RRM} = 2 \times 1600 \text{ V}$$

$$I_{FAV} = 310 \text{ A}$$

$$V_F = 1.03 \text{ V}$$

Phase leg

Part number

MDD312-16N1

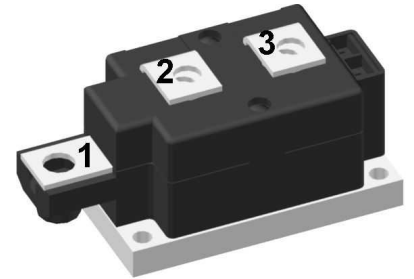

Backside: isolated

 E72873



Features / Advantages:

- Package with DCB ceramic
- Improved temperature and power cycling
- Planar passivated chips
- Very low forward voltage drop
- Very low leakage current

Applications:

- Diode for main rectification
- For single and three phase bridge configurations
- Supplies for DC power equipment
- Input rectifiers for PWM inverter
- Battery DC power supplies
- Field supply for DC motors

Package: Y1

- Isolation Voltage: 3600 V~
- Industry standard outline
- RoHS compliant
- Base plate: Copper internally DCB isolated
- Advanced power cycling

Terms Conditions of usage:

The data contained in this product data sheet is exclusively intended for technically trained staff. The user will have to evaluate the suitability of the product for the intended application and the completeness of the product data with respect to his application. The specifications of our components may not be considered as an assurance of component characteristics. The information in the valid application- and assembly notes must be considered. Should you require product information in excess of the data given in this product data sheet or which concerns the specific application of your product, please contact your local sales office.

Due to technical requirements our product may contain dangerous substances. For information on the types in question please contact your local sales office.

Should you intend to use the product in aviation, in health or life endangering or life support applications, please notify. For any such application we urgently recommend

- to perform joint risk and quality assessments;

- the conclusion of quality agreements;

- to establish joint measures of an ongoing product survey, and that we may make delivery dependent on the realization of any such measures.

Rectifier				Ratings			
Symbol	Definition	Conditions		min.	typ.	max.	Unit
V_{RSM}	max. non-repetitive reverse blocking voltage					1700	V
V_{RRM}	max. repetitive reverse blocking voltage					1600	V
I_R	reverse current	$V_R = 1600$ V		$T_{VJ} = 25^\circ\text{C}$		500	μA
		$V_R = 1600$ V		$T_{VJ} = 150^\circ\text{C}$		30	mA
V_F	forward voltage drop	$I_F = 300$ A		$T_{VJ} = 25^\circ\text{C}$		1.13	V
		$I_F = 600$ A				1.33	V
		$I_F = 300$ A		$T_{VJ} = 125^\circ\text{C}$		1.03	V
		$I_F = 600$ A				1.29	V
I_{FAV}	average forward current	$T_C = 100^\circ\text{C}$		$T_{VJ} = 150^\circ\text{C}$		310	A
$I_{F(RMS)}$	RMS forward current	180° sine	d = 0.5			520	A
V_{F0}	threshold voltage	} for power loss calculation only		$T_{VJ} = 150^\circ\text{C}$		0.80	V
r_F	slope resistance					0.6	m Ω
R_{thJC}	thermal resistance junction to case					0.12	K/W
R_{thCH}	thermal resistance case to heatsink				0.04		K/W
P_{tot}	total power dissipation			$T_C = 25^\circ\text{C}$		1040	W
I_{FSM}	max. forward surge current	t = 10 ms; (50 Hz), sine		$T_{VJ} = 45^\circ\text{C}$		10.8	kA
		t = 8,3 ms; (60 Hz), sine		$V_R = 0$ V		11.7	kA
		t = 10 ms; (50 Hz), sine		$T_{VJ} = 150^\circ\text{C}$		9.18	kA
		t = 8,3 ms; (60 Hz), sine		$V_R = 0$ V		9.92	kA
I^2t	value for fusing	t = 10 ms; (50 Hz), sine		$T_{VJ} = 45^\circ\text{C}$		583.2	kA ² s
		t = 8,3 ms; (60 Hz), sine		$V_R = 0$ V		566.1	kA ² s
		t = 10 ms; (50 Hz), sine		$T_{VJ} = 150^\circ\text{C}$		421.4	kA ² s
		t = 8,3 ms; (60 Hz), sine		$V_R = 0$ V		409.0	kA ² s
C_J	junction capacitance	$V_R = 400$ V; f = 1 MHz		$T_{VJ} = 25^\circ\text{C}$		381	pF

Package Y1				Ratings		
Symbol	Definition	Conditions	min.	typ.	max.	Unit
I_{RMS}	RMS current	per terminal			600	A
T_{VJ}	virtual junction temperature		-40		150	°C
T_{op}	operation temperature		-40		125	°C
T_{stg}	storage temperature		-40		125	°C
Weight				680		g
M_D	mounting torque		4.5		7	Nm
M_T	terminal torque		11		13	Nm
$d_{Spp/APP}$	creepage distance on surface striking distance through air	terminal to terminal	16.0			mm
$d_{Spb/APb}$		terminal to backside	16.0			mm
V_{ISOL}	isolation voltage	t = 1 second	3600			V
		t = 1 minute	3000			V

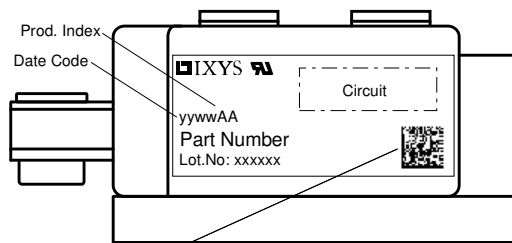

Data Matrix: Typ (1-19), DC+Prod.Index (20-25), FKT# (26-31)
leer (33), lfd.# (33-36)

Ordering	Ordering Number	Marking on Product	Delivery Mode	Quantity	Code No.
Standard	MDD312-16N1	MDD312-16N1	Box	3	463442

Similar Part	Package	Voltage class
MDD312-12N1	Y1-CU	1200
MDD312-14N1	Y1-CU	1400
MDD312-18N1	Y1-CU	1800
MDD312-20N1	Y1-CU	2000
MDD312-22N1	Y1-CU	2200

Equivalent Circuits for Simulation

* on die level

$T_{VJ} = 150\text{ °C}$

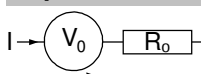

Rectifier

$V_{0\ max}$	threshold voltage	0.8	V
$R_{0\ max}$	slope resistance *	0.4	mΩ

Outlines Y1

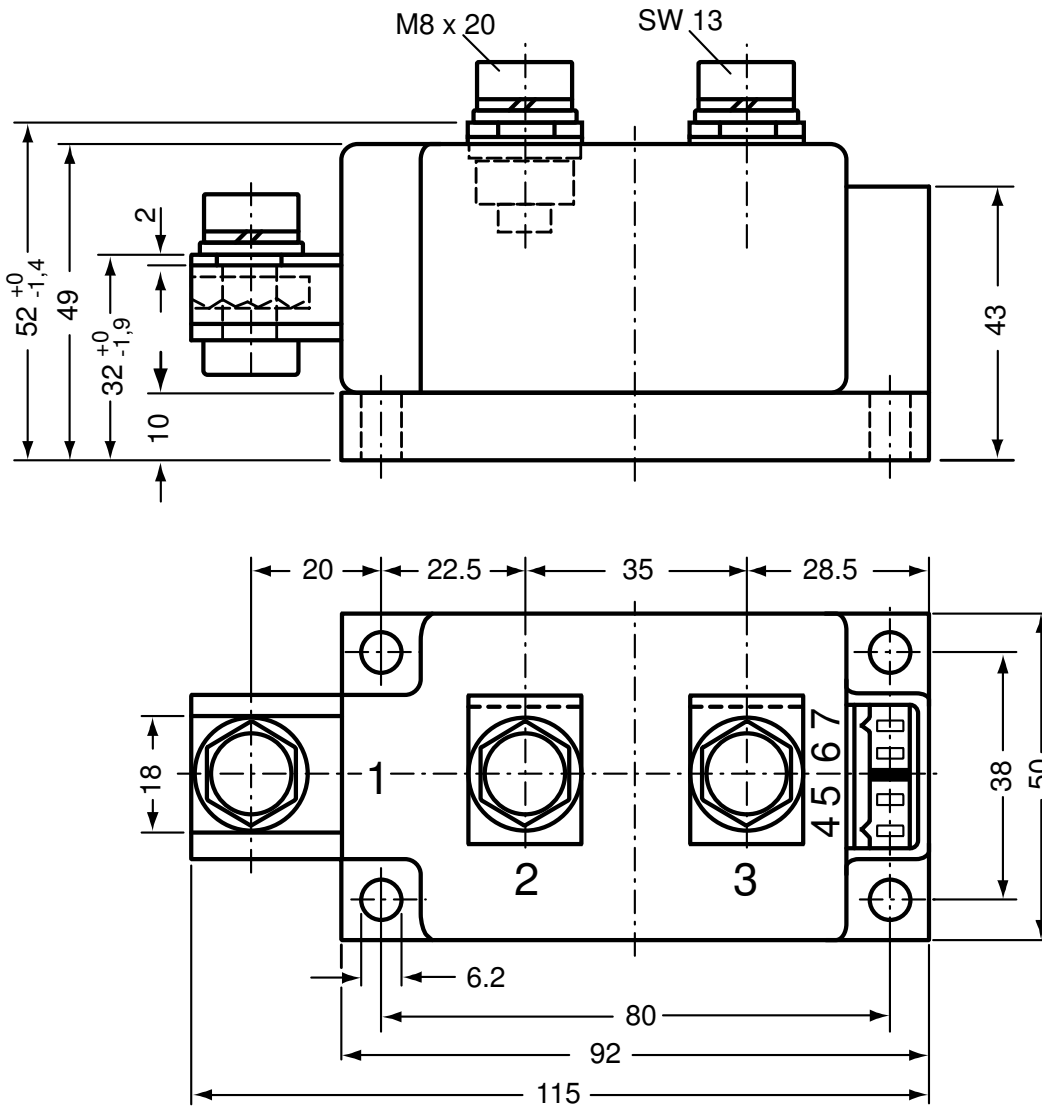

Optional accessories for modules

Keyed gate/cathode twin plugs with wire length = 350 mm, gate = white, cathode = red

Type ZY 180L (L = Left for pin pair 4/5)
 Type ZY 180R (R = Right for pin pair 6/7) } UL 758, style 3751

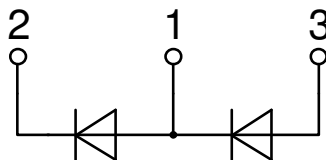

Rectifier

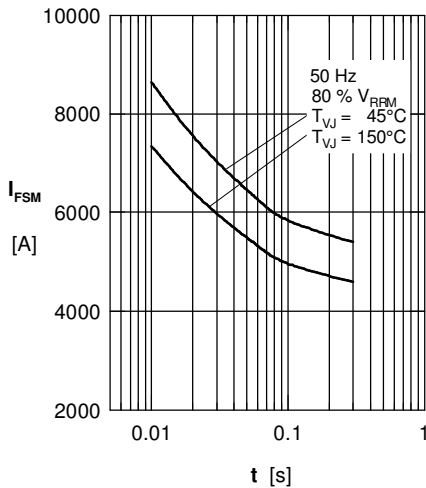

Fig. 1 Surge overload current
 I_{FSM} : Crest value, t : duration

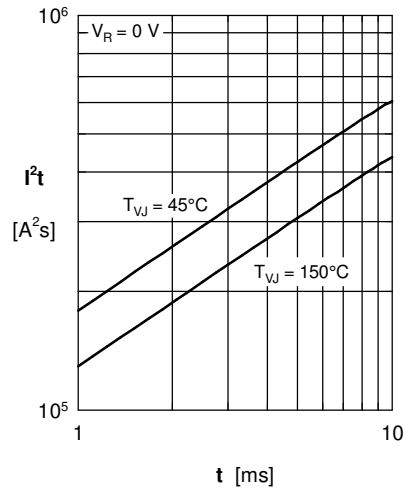

Fig. 2 I^2t versus time (1-10 ms)

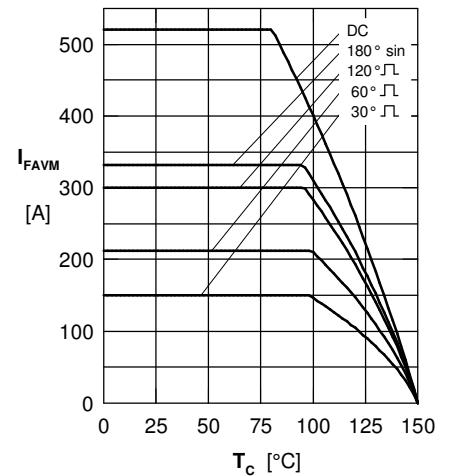

Fig. 3 Maximum forward current at case temperature

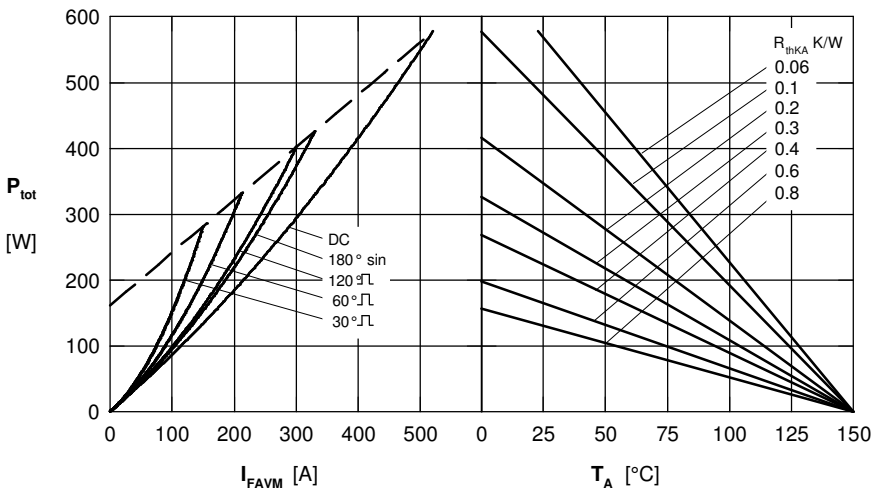

Fig. 4 Power dissipation vs. forward current & ambient temperature (per diode)

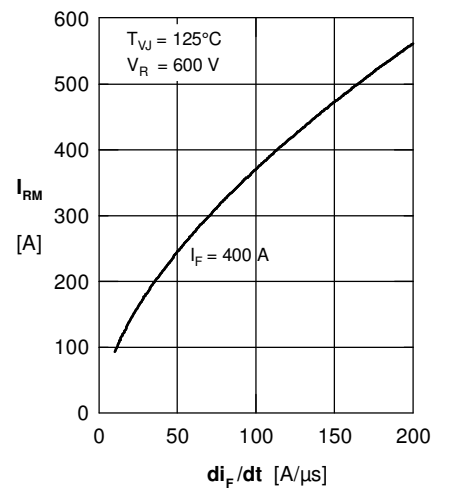

Fig. 5 Typ. peak reverse current

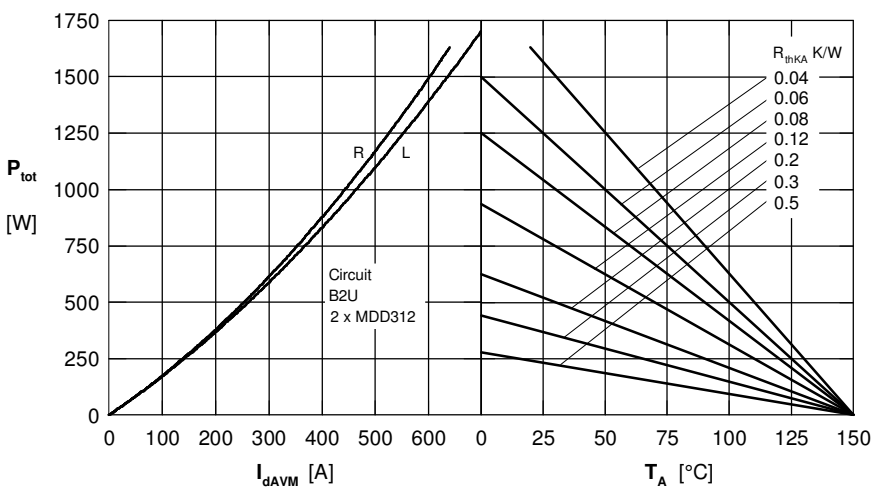

Fig. 6 Single phase rectifier bridge: Power dissipation vs. direct output current and ambient temperature $R =$ resistive load, $L =$ inductive load

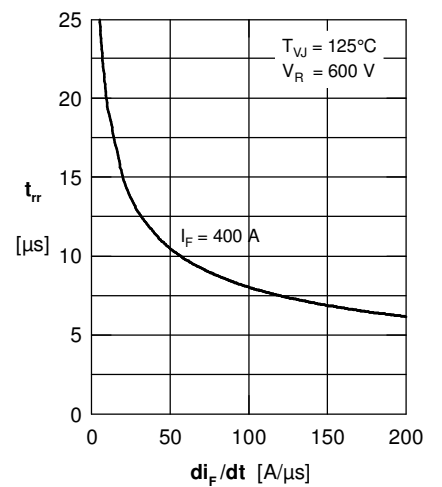

Fig. 7 Typ. recovery time t_{rr} versus $-di_F/dt$

Rectifier

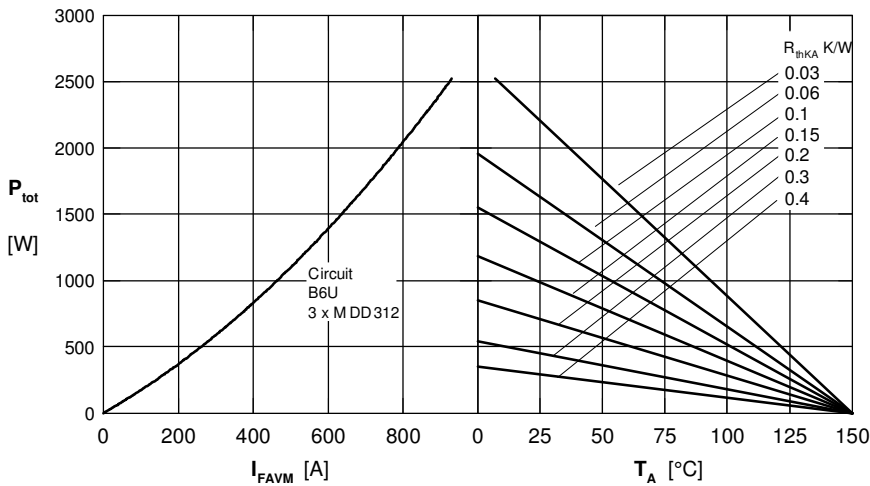

Fig. 8 Three phase rectifier bridge: Power dissipation vs. direct output current & ambient temperature

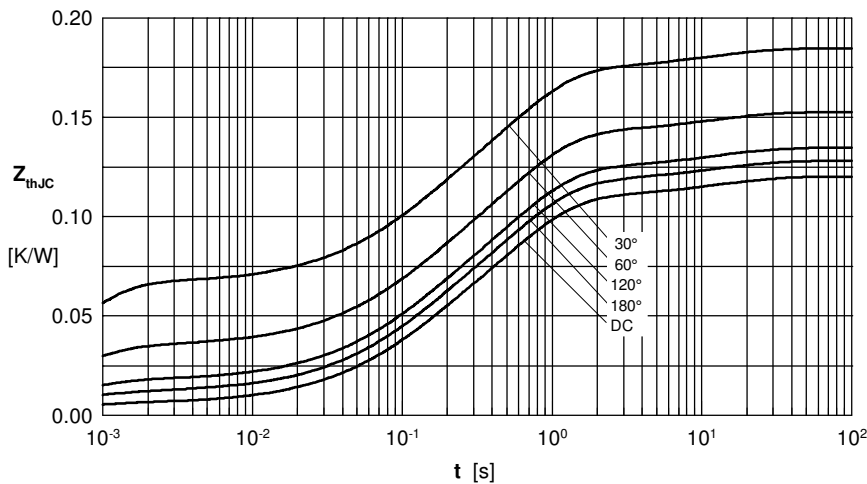

Fig. 9 Transient thermal impedance junction to case (per diode)

R_{thJC} for various conduction angles d :

d	R_{thJC} [K/W]
DC	0.120
180°	0.128
120°	0.135
60°	0.153
30°	0.185

Constants for Z_{thJC} calculation:

i	R_{thi} (K/W)	t_i (s)
1	0.0058	0.00054
2	0.0310	0.09800
3	0.0720	0.54000
4	0.0112	12.0000

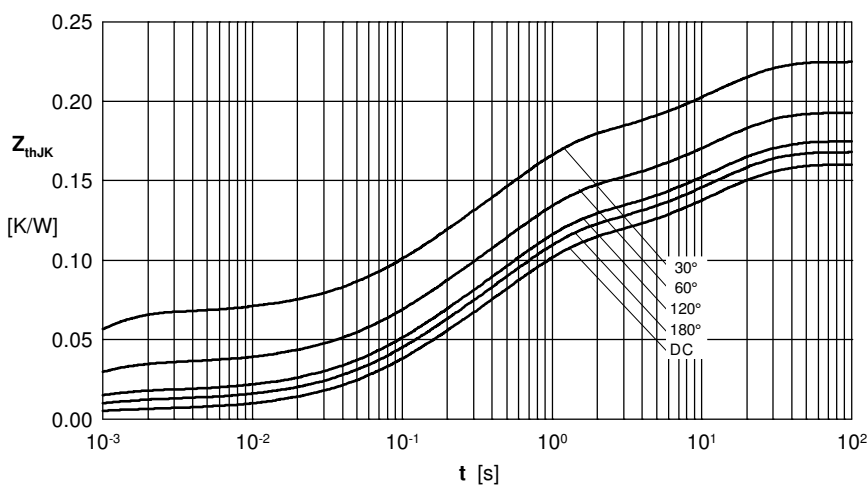

Fig. 10 Transient thermal impedance junction to heatsink (per diode)

R_{thJK} for various conduction angles d :

d	R_{thJK} [K/W]
DC	0.160
180°	0.168
120°	0.175
60°	0.193
30°	0.225

Constants for Z_{thJK} calculation:

i	R_{thi} (K/W)	t_i (s)
1	0.0058	0.00054
2	0.0310	0.09800
3	0.0720	0.54000
4	0.0112	12.0000
5	0.0400	12.0000